

Aluminum Electrolytic Capacitor

CapXon Catalog 2014/2015 Aluminum Electrolytic Capacitor



Aluminum
RoHS Compliance Electrolytic
Capacitor

ALUMINUM ELECTROLYTIC CAPACITORS

CONTENTS	PAGE
1. List of the Products	3
2. Product System	5
3. Part Number System	8
4. Lead Treatment	10
5. Package for SMD Type	16
6. Precautions & Guidelines	17
7. Individual Specification by Series	23
8. General technical information for Screw Type	219
9. Quality and environment for Screw Type	232

Note:1.Specification and dimensions in this catalogue are subject to change without notice. If necessary, drawing can be provided.
2.Catalogue printed in January 2014.

	Series Sleeve Color	Type	Features	Operating Temperature Range	Working Voltage	Capacitance	Leakage Current	Endurance Hours	Page
Conductive Polymer	PL	Radial	Very low ESR	-55 to +105 °C	2.5~16V	180~3500µF	≤ 0.2CV	2000	26
	PS	Radial	Standard	-55 to +105 °C	2.5~25V	39~3500µF	≤ 0.2CV	2000	29
	PU	Radial	Ultra low ESR	-55 to +105 °C	2.5~10V	180~3500µF	≤ 0.2CV	2000	34
	PX	Radial	Low profile	-55 to +105 °C	2.5~25V	10~820µF	≤ 300µA	2000	37
	PE	Radial	Ultra low ESR, Down size to 6.3X8 (mm)	-55 to +105 °C	2.5~6.3V	470~820µF	≤ 0.2CV	2000	41
	PW	Radial	Low height 2000Hours	-55 to +105 °C	2.5V~25V	39~2500µF	≤ 0.2CV	2000	42
	PH	Radial	High Voltage/High Reliability	-55 to +105 °C	35V~50V	10~150µF	≤ 0.2CV	2000	45
	PT	Radial	125 °C Guaranteed	-55 to +125 °C	2.5~16V	180~2500µF	≤ 0.2CV	2000	47
	PF	Radial	Long Life to 5,000Hours	-55 to +105 °C	2.5~16V	100~2700µF	≤ 0.2CV	5000	50
	PM	SMD	SMD & Low profile	-55 to +105 °C	2.5~25V	10~560µF	≤ 300µA	2000	53
	PD	SMD	SMD & Large capacitance	-55 to +105 °C	2.5~25V	39~3300µF	≤ 0.2CV	2000	56
PV	SMD	SMD & Low height	-55 to +105 °C	2.5~25V	39~2500µF	≤ 0.2CV	2000	59	
SMD type	EV	SMD	105 °C, Standard	-55 to +105 °C	6.3~50V	0.1~1500µF	0.01CV or 3µA	1000	62
	LV	SMD	85 °C, Standard	-40 to +85 °C	4~50V	0.1~6800µF	0.01CV or 3µA	2000	64
	HV	SMD	Wide temperature range	-55 to +105 °C	6.3~63V	0.1~6800µF	0.01CV or 3µA	2000	66
	JV	SMD	3000 hours life	-55 to +105 °C	6.3~50V	0.1~1000µF	0.01CV or 3µA	3000	68
	MV	SMD	5000 hours life	-40 to +105 °C	6.3~50V	0.1~1000µF	0.01CV or 3µA	5000	70
	NV	SMD	5.5 ~ 10.5mm height, Non-polar	-40 to +85 °C	6.3~50V	0.1~560µF	0.05CV or 10µA	2000	72
	KV	SMD	85 °C, Low leakage current	-40 to +85 °C	6.3~50V	0.1~330µF	0.002CV or 0.4µA	1000	74
	ZV	SMD	105 °C, Low impedance	-55 to +105 °C	6.3~50V	1~6800µF	0.01CV or 3µA	2000 ~ 5000	76
	DV	SMD	105 °C, Low impedance	-55 to +105 °C	6.3~50V	1~6800µF	I ≤ 0.01CV or 3µA	2000 ~ 5000	78
	RV	SMD	105 °C, Low impedance, LongLife	-55 to +105 °C	6.3~50V	1~6800µF	I ≤ 0.01CV or 3µA	2000 ~ 5000	80
TV	SMD	For high temperature + 125 °C	-40 to +125 °C	10~50V	10~330µF	0.03CV or 4µA	1000 ~ 2000	82	
Ultra-miniature type	SS	Radial	5mm, Standard, 85 °C	-40 to +85 °C	4~50V	0.1~330µF	0.01CV or 3µA	1000	84
	ST	Radial	5mm, Standard, 105 °C	-40 to +105 °C	4~50V	0.1~100µF	0.01CV or 3µA	1000	86
	SA	Radial	5mm, Low leakage current	-40 to +85 °C	4~50V	0.1~100µF	0.002CV or 0.4µA	1000	88
	SP	Radial	5mm, Non-polar	-40 to +85 °C	6.3~50V	0.1~47µF	0.05CV or 10µA	1000	90
	SM	Radial	7mm, Standard, 85 °C	-40 to +85 °C	4~63V	0.1~470µF	0.01CV or 3µA	1000	92
	SH	Radial	7mm, 85 °C, Long life	-40 to +85 °C	4~63V	0.1~470µF	0.01CV or 3µA	2000	94
	SK	Radial	7mm, Standard, 105 °C	-40 to +105 °C	4~63V	0.1~470µF	0.01CV or 3µA	1000	96
	SJ	Radial	7mm, 105 °C, Long life 2000 hours	-40 to +105 °C	6.3~63V	0.1~220µF	0.01CV or 3µA	2000	98
	SG	Radial	7mm, 105 °C, Long life 4000 hours	-40 to +105 °C	6.3~50V	0.1~470µF	0.01CV or 3µA	4000	100
	SL	Radial	7mm, Low leakage current, 85 °C	-40 to +85 °C	6.3~50V	0.1~220µF	0.002CV or 0.4µA	1000	102
	SD	Radial	7mm, Low leakage current, 105 °C	-40 to +105 °C	4~63V	0.1~100µF	0.002CV or 0.4µA	1000	104
	SN	Radial	7~ 9mm, Non-polar, 85 °C	-40 to +85 °C	6.3~50V	0.1~220µF	0.05CV or 10µA	1000	106
	SB	Radial	7mm, Non-polar, 105 °C	-40 to +105 °C	6.3~50V	0.1~100µF	0.05CV or 10µA	1000	108
	SZ	Radial	7mm, Low impedance	-55 to +105 °C	6.3~35V	6.8~330µF	0.01CV or 3µA	1000	110
SY	Radial	7mm, Low impedance, Long life	-55 to +105 °C	6.3~50V	1~330µF	0.01CV or 3µA	2000	112	
Standard type	GS (GR)	Radial	General purpose, 85 °C	-40 to +85 °C -25 to +85 °C	6.3~100V 160~450V	0.1~33000µF 0.47~470µF	0.01CV or 3µA 0.03CV	2000	114
	GW	Radial	9~21mm height low profile, 85 °C	-40 to +85 °C -25 to +85 °C	6.3~100V 160~450V	2.2~10000µF 2.2~220µF	0.01CV or 3µA 0.04CV + 100µA	2000	118
	KM	Radial	Standard, 105 °C	-40 to +105 °C -25 to +105 °C	6.3~100V 160~450V	0.1~22000µF 0.47~470µF	0.01CV or 3µA 0.03CV	2000	120
	KW	Radial	9~21mm height low profile, 105 °C	-40 to +105 °C -25 to +105 °C	6.3~100V 160~450V	2.2~10000µF 1.5~220µF	0.01CV or 3µA 0.04CV + 100µA	2000	124
	KC	Radial	Ultra Miniaturized	-25 to +105 °C	400~450V	82~220µF	I ≤ 3 √CV	3000	126
LL	Radial	Low leakage current	-40 to +105 °C	6.3~63V	0.1~2200µF	0.002CV or 0.4µA	2000	128	
Low Impedance / ESR type	GL	Radial	Low impedance and Low ESR Miniaturized	-55 to +105 °C	6.3~63V	0.47~10000µF	0.01CV or 3µA	2000 ~ 6000	130
	KF	Radial	Low impedance for power supply	-40 to +105 °C -25 to +105 °C	6.3~100V 160~450V	0.47~15000µF 0.47~220µF	0.01CV or 3µA 0.03CV	2000 ~ 5000	133
	KZ	Radial	Low impedance	-40 to +105 °C	6.3~50V	0.47~6800µF	0.01CV or 3µA	1000 ~ 2000	138
	GF	Radial	Low impedance	-55 to +105 °C	6.3V~100V	4.7~6800µF	0.01CV or 3µA	2000 ~ 5000	141
	LZ	Radial	Ultra low ESR and High ripple current	-40 to +105 °C	6.3~25V	220~3300µF	0.01CV or 3µA	2000	146
GH	Radial	High temperature and Long life	-55 to +105 °C	6.3~50V	0.47~6800µF	0.01CV or 3µA	3000 ~ 10000	148	

	Series Sleeve Color	Type	Features	Operating Temperature Range	Working Voltage	Capacitance	Leakage Current	Endurance Hours	Page
High reliability type	FH	Radial	Ultra Low ESR and Long Life	-40 to +105 °C	6.3V~100V	22~5600µF	0.01CV or 3µA	4000 ~ 10000	151
	KL	Radial	Long life 5,000 hours	-25 to +105 °C	160~450V	10~220µF	0.04CV + 100µA	5000	155
	KH	Radial	Long life 5,000~10,000 hours	-40 to +105 °C -25 to +105 °C	10~50V 160~450V	6.8~3300µF 6.8~220µF	0.01CV or 3µA 0.04CV + 100µA	5000 ~ 10000	157
	TH	Radial	For high temperature +125 °C	-40 to +125 °C -25 to +125 °C	10~100V 160~350V	0.47~1000µF 1~100µF	0.01CV or 3µA 0.02CVµA	1000 ~ 2000	159
	TE	Radial	For high temperature +130 °C	-40 to +130 °C	10~50V	3.3~4700µF	0.01CV or 3µA	2000 ~ 3000	161
	KS	Radial	Over voltage vent operating facility	-25 to +105 °C	200,400WV	4.7~470µF	0.03CV	2000	163
	FK	Radial	Long life for LED and ballast	-25 to +105 °C	160~450WV	1~330µF	0.04CV+100µA	6000 ~ 8000	165
	FL	Radial	Long life for LED and ballast	-25 to +105 °C	160~450WV	1~330µF	0.04CV+100µA	8000 ~ 10000	167
	LE	Radial	Long life for LED lighting	-25 to +105 °C	160~450WV	1~68µF	0.04CV+100µA	10000 ~ 15000	169
	KY	Radial	Slim type	-25 to +105 °C	250~450WV	10~150µF	$I \leq 3 \sqrt{CV}$	2000	171
	LY	Radial	Slim type, longlife 5000hours	-25 to +105 °C	250~450WV	10~150µF	$I \leq 3 \sqrt{CV}$	5000	173
	HY	Radial	Slim type, longlife 10000hours	-25 to +105 °C	250~450WV	12~120µF	$I \leq 3 \sqrt{CV}$	10000	175
Non/Bi polarized type	NP	Radial	Non-polarized, 85 °C	-40 to +85 °C -25 to +85 °C	6.3~100V 160~250V	0.47~3300µF 0.47~47µF	0.03CV or 3µA	2000	177
	NK	Radial	Non-polarized, 105 °C	-40 to +105 °C -25 to +105 °C	6.3~100V 160~250V	0.47~3300µF 0.47~47µF	0.03CV or 3µA	2000	179
	BP	Radial	Bi-polarized	-40 to +105 °C	25/50/63V	2.2~15µF	100µA	2000	181
For Audio Equipment	SW	Radial	5mm height, for audio equipment	-40 to +85 °C	4~50V	0.1~470µF	0.01CV or 3µA	1000	183
	SR	Radial	7mm height, for audio equipment	-40 to +85 °C	6.3~50V	0.1~220µF	0.01CV or 3µA	1000	185
	RW	Radial	Standard, for audio equipment	-40 to +85 °C	6.3~100V	0.1~33,000µF	0.01CV or 3µA	2000	187
	NR	Radial	Non-polar, for audio equipment	-40 to +85 °C	6.3~100V	0.47~1,000µF	0.03CV or 3µA	2000	189
	LR	Snap-in	85 °C, for audio equipment	-40 to +85 °C	16~100V	680~33,000µF	0.02CVµA	2000	191
Large can type	LP	Snap-in	85 °C, Standard	-40 to +85 °C -25 to +85 °C	10~100V 160~450V	470~68000µF 47~2700µF	0.02CVµA	2000	196
	LS	Snap-in	85 °C, Miniaturized	-25 to +85 °C	160~450V	47~2700µF	0.02CVµA	2000	200
	LU	Snap-in	85 °C, Longlife 3000hours	-40 to +85 °C -25 to +85 °C	16~100V 160~450V	820~47000µF 56~2700µF	$I \leq 3 \sqrt{CV}$	3000	203
	HP	Snap-in	105 °C, Standard	-40 to +105 °C -25 to +105 °C	10~100V 160~450V	330~68000µF 33~2200µF	0.02CVµA	2000	207
	HS	Snap-in	105 °C, Miniaturized	-25 to +105 °C	160~450V	33~2700µF	0.02CVµA	2000	211
	HW	Snap-in	105 °C, Low Profile 15mm height	-25 to +105 °C	160~400V	39~390µF	$I \leq 3 \sqrt{CV}$	2000	214
	HU	Snap-in	105 °C, Longlife 3000hours	-40 to +105 °C -25 to +105 °C	16~100V 160~450V	560~47000µF 47~2700µF	$I \leq 3 \sqrt{CV}$	3000	216
	HL	Snap-in	Long life with low ESR	-40 to +105 °C -25 to +105 °C	10~100V 160~400V	560~47000µF 56~1500µF	0.02CVµA	5000	220
	LT	Snap-in	4 Snap-in terminals type	-40 to +85 °C -25 to +85 °C	16~100V 160~450V	4700~82000µF 330~3300µF	0.02CVµA	2000	225
	HT	Snap-in	4 Snap-in terminals type	-25 to +105 °C	160~400V	82~1200µF	0.02CVµA	2000	227
For inverter air conditioner	UB	Snap-in	Useful life 4000hours	-25 to +85 °C	400~450V	330~1200µF	$I \leq 3 \sqrt{CV}$	2000	229
	UC	Snap-in	Useful life 6000hours	-25 to +85 °C	400~450V	330~1200µF	$I \leq 3 \sqrt{CV}$	3000	231
	UD	Snap-in	Useful life 10000hours	-25 to +85 °C	400~450V	330~1200µF	$I \leq 3 \sqrt{CV}$	5000	233
	UJ	Snap-in	Useful life 3000hours	-25 to +105 °C	400~450V	330~1200µF	$I \leq 3 \sqrt{CV}$	2000	235
	UK	Snap-in	Useful life 5000hours	-25 to +105 °C	400~450V	330~1200µF	$I \leq 3 \sqrt{CV}$	3000	237
	UL	Snap-in	Useful life 7000hours	-25 to +105 °C	400~450V	330~1000µF	$I \leq 3 \sqrt{CV}$	5000	239
	Photo flash type	RF	Radial	Photo flash equipment	-20 to +55 °C	330/350V	100~450µF	1XCµA	5000times
SF		Snap-in	Photo flash equipment	-20 to +55 °C	330/350V	150~1500µF	1XCµA	5000times	242
RS		Screw	General	-40 to +85 °C	16~100V	3300~1000000µF	$\leq 0.3\mu A * (C * V)^{0.7} + 4\mu A$	2000	261
RG		Screw	Useful life 6000hours	-25 to +85 °C	160~450V	680~68000µF	$\leq 0.3\mu A * (C * V)^{0.7} + 4\mu A$	2000	264
RP		Screw	Useful life 10000hours	-25 to +85 °C	160~450V	680~68000µF	$\leq 0.3\mu A * (C * V)^{0.7} + 4\mu A$	2000	269
RX		Sxrew	useful life 20000hours	-25 to +85 °C	160~450V	220~47000µF	$\leq 0.3\mu A * (C * V)^{0.7} + 4\mu A$	5000	274
RU		Screw	useful life 12000hours high ripple current	-25 to +85 °C	350~450V	1000~22000µF	$\leq 0.3\mu A * (C * V)^{0.7} + 4\mu A$	2000	278
RJ		Screw	useful life 10000hours with stud	-25 to +85 °C	350~450V	1500~22000µF	$\leq 0.3\mu A * (C * V)^{0.7} + 4\mu A$	2000	282
RY		Screw	useful life 12000hours high ripple current with stud	-25 to +85 °C	350~450V	1500~22000µF	$\leq 0.3\mu A * (C * V)^{0.7} + 4\mu A$	2000	286
RK		Screw	General	-40 to +105 °C	16~100V	1500~1000000µF	$\leq 0.3\mu A * (C * V)^{0.7} + 4\mu A$	2000	290
RL		Screw	Long life	-25 to +105 °C	350~450V	680~15000µF	$\leq 0.3\mu A * (C * V)^{0.7} + 4\mu A$	5000	293
RM		Screw	useful life 6000hours	-25 to +105 °C	160~450V	220~47000µF	$\leq 0.3\mu A * (C * V)^{0.7} + 4\mu A$	2000	296
RH		Screw	useful life 8000hours high ripple current	-25 to +105 °C	160~450V	220~47000µF	$\leq 0.3\mu A * (C * V)^{0.7} + 4\mu A$	2000	300
RQ		Screw	useful life 6000hours with stud	-25 to +105 °C	160~450V	2200~47000µF	$\leq 0.3\mu A * (C * V)^{0.7} + 4\mu A$	2000	304
RT		Screw	useful life 8000hours high ripple current with stud	-25 to +105 °C	160~450V	2200~47000µF	$\leq 0.3\mu A * (C * V)^{0.7} + 4\mu A$	2000	308

Conductive Polymer AL.E. Capacitors Radial type

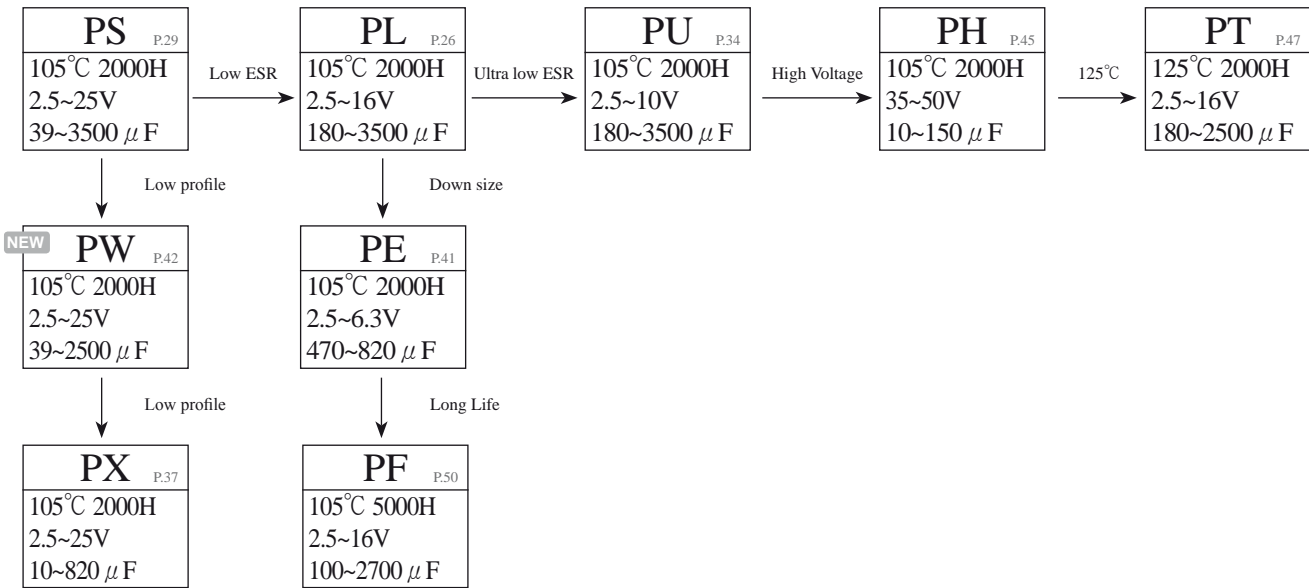

Conductive Polymer AL.E. Capacitors SMD type

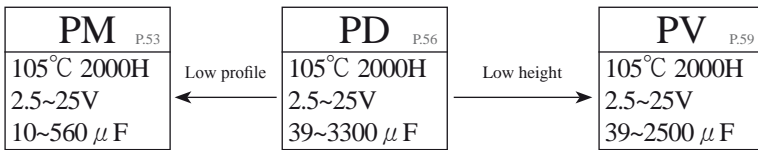

Aluminum Electrolytic Capacitors SMD type

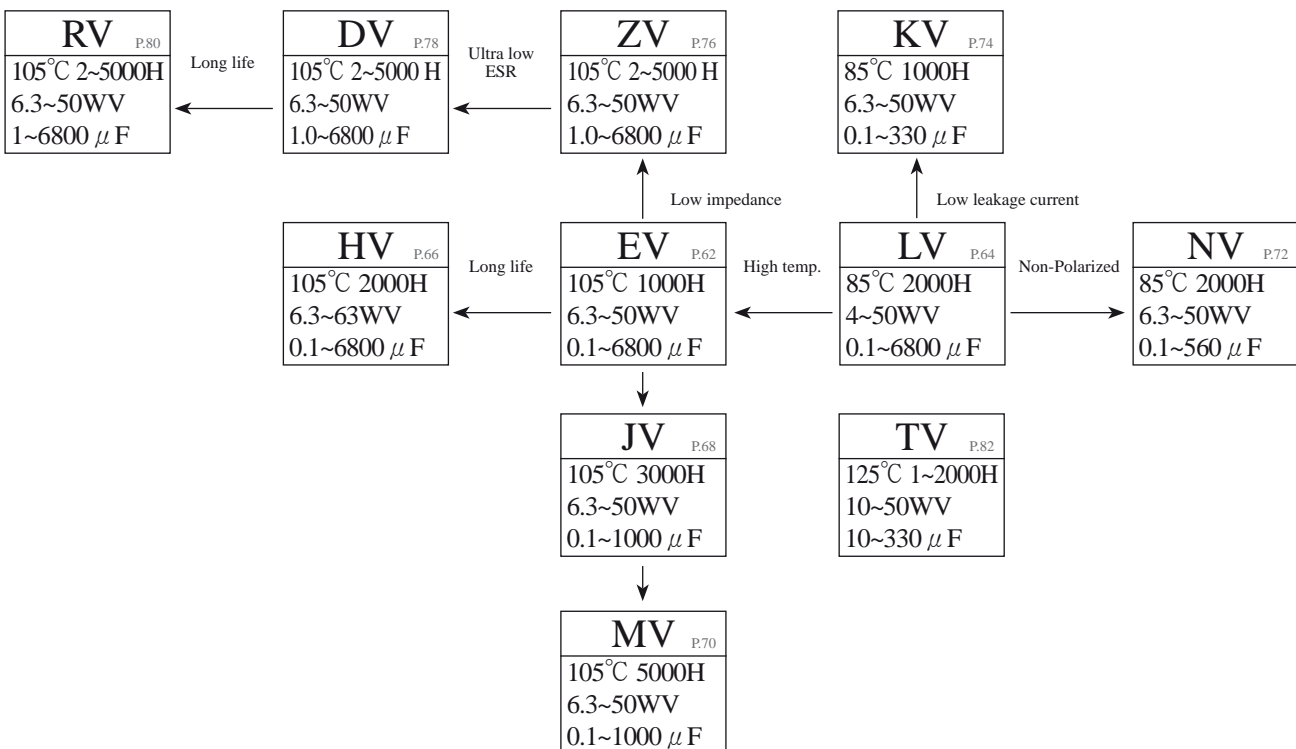

Aluminum Electrolytic Capacitors for audio equipment

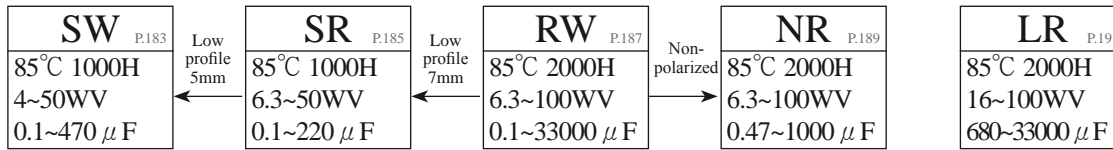

Snap-in type of aluminum Electrolytic Capacitors

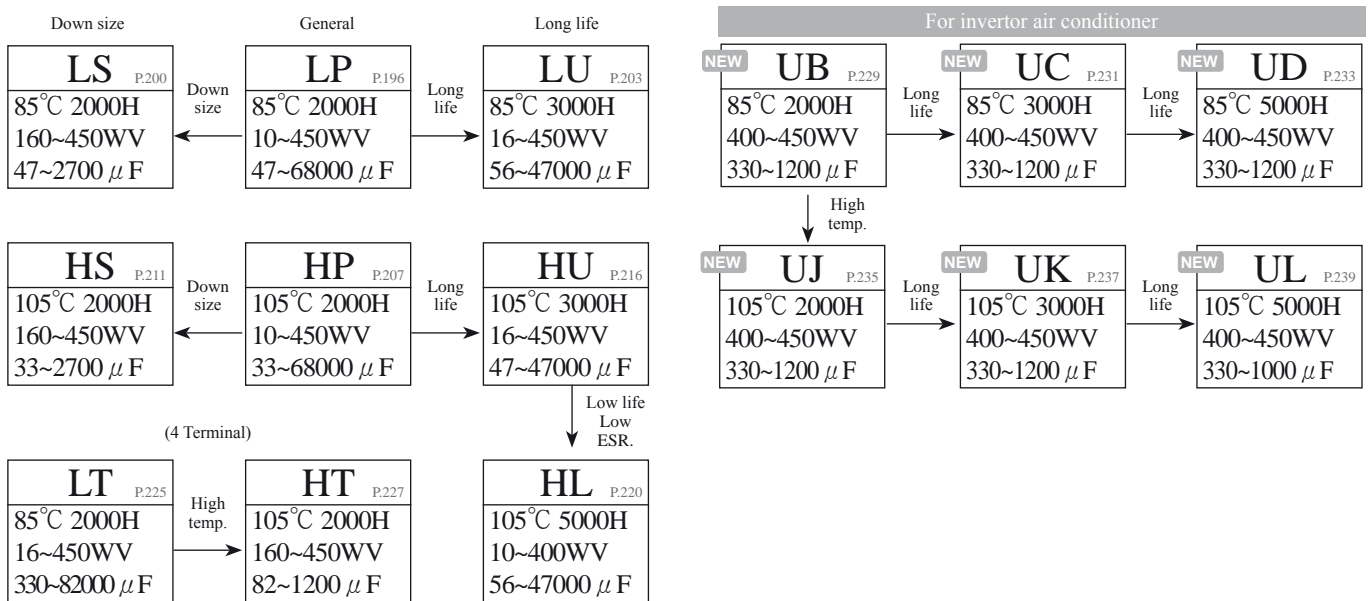
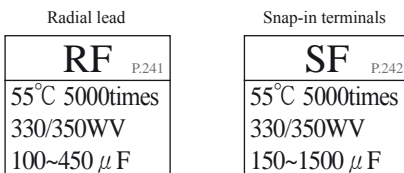
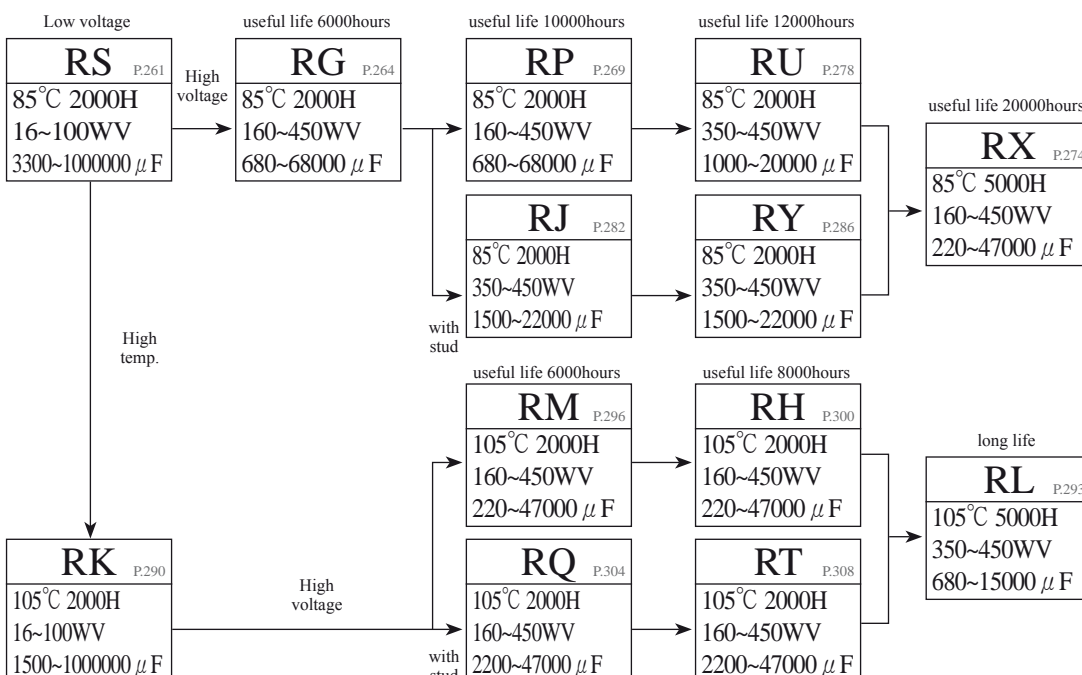
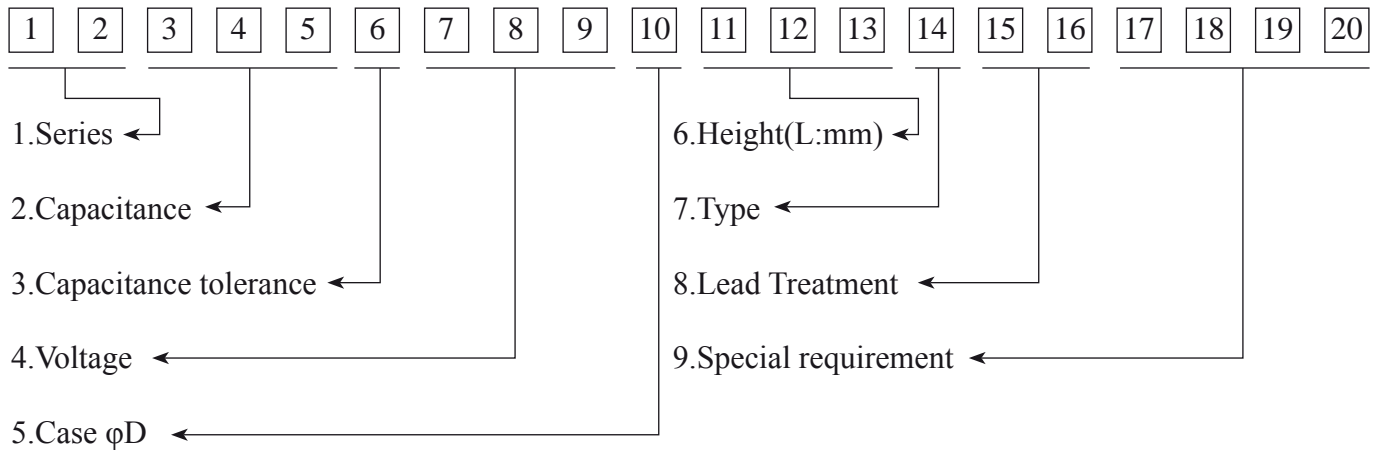

Photo flash type of aluminum Electrolytic Capacitors



Screw type of aluminum Electrolytic Capacitors





(1) Series

For the details, please refer to "List of the Products" on page3.

(2) Capacitance

Capacitance is shown in microfarads(uF)

μF	0.1	0.47	1	4.7	10	100	1000	10000
Code	oR1	R47	010	4R7	100	101	102	103

(3) Capacitance tolerance

Tolerance%	±5	±10	±20	±30	-10to+30	-10to+50	-10to+20	-10to100	0to+20	-30to+0	±15
Code	H	K	M	N	Q	T	V	W	Z	U	S
Tolerance%	0to+30	0to+40	0to+50	-5to+20	-8to+5	+5to+20	0to-20	-15to+20	-25to+20	-50to+0	-5to+30
Code	Y	X	A	J	E	I	B	P	L	O	C

(4) Voltage(W.V)

Voltage(W.V)	6.3	10	16	25	35	50	63	80	100	160	200	220	250	350	400	420	450	500
Code	6R3	010	016	025	035	050	063	080	100	160	200	220	250	350	400	420	450	500

(5) Case(φD)

Diameter	3	4	5	6.3	8	10	12	12.5	13	14.5	16	18	20	22	25	30	35	40	42	45	51	63.5	76.2	89	100
Code	A	B	C	E	F	G	H	Z	I	Y	J	K	L	M	N	O	P	Q	U	V	R	S	T	X	D

(6) Height(L:mm)

Height	5	7.5	11	11.5	12	12.5	16	21	25	26	25.5	31.5	35	35.5	41	47	52	83	98	118	141	151	230
Code	050	075	110	115	120	125	160	210	250	260	255	315	350	355	410	470	520	830	980	A18	A41	A51	B30

(7) Type

Type	Without Lead Treatment	With Lead Treatment	Polymer
Code	A	E	P

(8) Lead Treatment

For the details, please refer to page9-13.

(9) Special & appearance requirement (The 17th, 18th, 19th, 20th code)

Code	Special
A	Terminal
B	Rubber
C	Lead wire
D	DF
E	Electrolyte
F	Pitch
G	Fill glue
H	Height requirement

Code	Special
I	LC
K	Vent line
L	Life
N	Nude
P	Sleeve, tray, print, PVC sleeve
Q	Capacitance, Cv, Break
R	Ripple current
S	Countermeasure

Code	Special
T	Temperature characteristic
V	Vt, Electrolyte paper
M	solder, technics, form
Y	Case with snail, clip loop
Z	Impedance
U	Package& Label

Remark:

1. If it's without lead treatment & special requirement, the 14th code is blank
2. If it's with lead treatment & without require special requirement, the 17th 18th 19th 20th code is blank
3. If it's without lead treatment, but, with special requirement, the 15th 16th code filled with 0.
4. If it's without lead treatment, but with special requirement, also exceed 4 kinds, keystone characteristic is 4code.
5. If it's with lead treatment, but with 1 special requirement, only remark 17 code, latter three code is blank.
6. If it's with led treatment, but with 1 special requirement, and it is different from former data, the 17th is 0, the 18th code is characteristic.

Standard

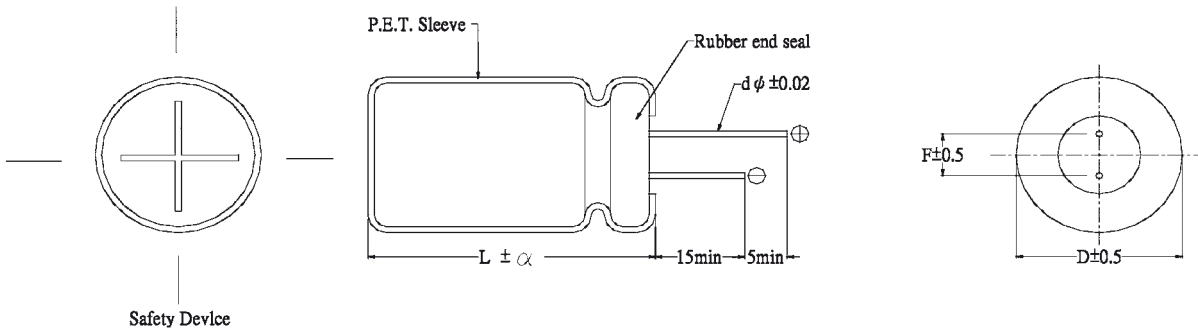



α	D < 18	D = 18		D > 18
	1.5	L < 35.5	L ≥ 35.5	2

Dφ	3	4	5	6.3	8		10	13	14.5	16	18	20	22	25
F	1.0	1.5	2.0	2.5	L < 20	L ≥ 20	5.0		7.5		10			12.5
dφ	0.4	0.45	0.5		0.6		0.6		0.8				1.0	

Cutting & Forming

Part No. Code (15th, 16th)	Cutting & Forming	Size (mm)																																			
CF		<p>Fig1</p> <table border="1"> <tr> <td>Dφ</td> <td>4</td> <td>5</td> </tr> <tr> <td>F</td> <td>2</td> <td>2.5</td> </tr> </table> <p>Fig2</p> <table border="1"> <tr> <td>Dφ</td> <td>4</td> <td>4</td> <td>4</td> <td>5</td> <td>5</td> <td>6.3</td> <td>6.3</td> <td>8</td> <td>10</td> <td>13</td> </tr> <tr> <td>F</td> <td>2.5</td> <td>3.5</td> <td>5</td> <td>3.5</td> <td>5</td> <td>3.5</td> <td>5</td> <td>5</td> <td>7.5</td> <td>7.5</td> </tr> </table>	Dφ	4	5	F	2	2.5	Dφ	4	4	4	5	5	6.3	6.3	8	10	13	F	2.5	3.5	5	3.5	5	3.5	5	5	7.5	7.5							
Dφ	4	5																																			
F	2	2.5																																			
Dφ	4	4	4	5	5	6.3	6.3	8	10	13																											
F	2.5	3.5	5	3.5	5	3.5	5	5	7.5	7.5																											
KF		<p>Fig1</p> <table border="1"> <tr> <td>Dφ</td> <td>4</td> <td>5</td> </tr> <tr> <td>F</td> <td>2</td> <td>2.5</td> </tr> <tr> <td>E</td> <td>1.12</td> <td>1.12</td> </tr> <tr> <td>H1</td> <td>4</td> <td>4</td> </tr> <tr> <td>H2</td> <td>1.8</td> <td>1.8</td> </tr> </table> <p>Fig2</p> <table border="1"> <tr> <td>Dφ</td> <td>5</td> <td>6.3</td> <td>8</td> </tr> <tr> <td>F</td> <td>5</td> <td>5</td> <td>5</td> </tr> <tr> <td>E</td> <td>1.12</td> <td>1.12</td> <td>1.32</td> </tr> <tr> <td>H1</td> <td>4</td> <td>4</td> <td>4</td> </tr> <tr> <td>H2</td> <td>1.8</td> <td>1.8</td> <td>1.8</td> </tr> </table>	Dφ	4	5	F	2	2.5	E	1.12	1.12	H1	4	4	H2	1.8	1.8	Dφ	5	6.3	8	F	5	5	5	E	1.12	1.12	1.32	H1	4	4	4	H2	1.8	1.8	1.8
Dφ	4	5																																			
F	2	2.5																																			
E	1.12	1.12																																			
H1	4	4																																			
H2	1.8	1.8																																			
Dφ	5	6.3	8																																		
F	5	5	5																																		
E	1.12	1.12	1.32																																		
H1	4	4	4																																		
H2	1.8	1.8	1.8																																		

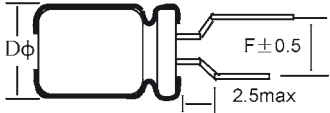
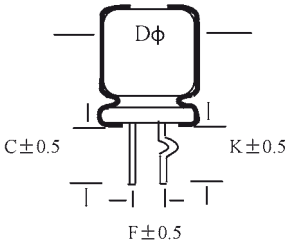
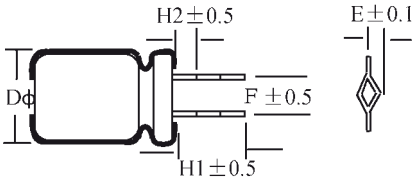
Part No. Code (15th, 16th)	Cutting & Forming	Size (mm)																																													
CA		<table border="1"> <tr> <td>Dφ</td> <td>4</td> <td>5</td> <td>6.3</td> <td>8</td> <td>10</td> <td>13</td> <td>16</td> <td>18</td> <td>22</td> <td>25</td> </tr> <tr> <td>F</td> <td>1.5</td> <td>2</td> <td>2.5</td> <td>3.5</td> <td>5</td> <td>5</td> <td>7.5</td> <td>7.5</td> <td>10</td> <td>12.5</td> </tr> </table>	Dφ	4	5	6.3	8	10	13	16	18	22	25	F	1.5	2	2.5	3.5	5	5	7.5	7.5	10	12.5																							
Dφ	4	5	6.3	8	10	13	16	18	22	25																																					
F	1.5	2	2.5	3.5	5	5	7.5	7.5	10	12.5																																					
FA	 <p>Fig1</p>	<table border="1"> <tr> <td>Dφ</td> <td>4</td> <td>5</td> </tr> <tr> <td>F</td> <td>2</td> <td>2.5</td> </tr> </table>	Dφ	4	5	F	2	2.5																																							
	Dφ	4	5																																												
F	2	2.5																																													
	 <p>Fig2</p>	<table border="1"> <tr> <td>Dφ</td> <td>4</td> <td>5</td> <td>6.3</td> <td>8</td> <td>10</td> <td>13</td> </tr> <tr> <td>F</td> <td>5</td> <td>5</td> <td>5</td> <td>5</td> <td>7.5</td> <td>7.5</td> </tr> </table>	Dφ	4	5	6.3	8	10	13	F	5	5	5	5	7.5	7.5																															
Dφ	4	5	6.3	8	10	13																																									
F	5	5	5	5	7.5	7.5																																									
CK		<table border="1"> <tr> <td>Dφ</td> <td>4</td> <td>5</td> <td>6.3</td> <td>8</td> <td>10</td> <td>13</td> <td>16</td> <td>18</td> </tr> <tr> <td>F</td> <td>1.5</td> <td>2</td> <td>2.5</td> <td>3.5</td> <td>5</td> <td>5</td> <td>7.5</td> <td>7.5</td> </tr> <tr> <td>C</td> <td>4</td> <td>4</td> <td>4</td> <td>4</td> <td>4.5</td> <td>4.5</td> <td>4.5</td> <td>4.5</td> </tr> <tr> <td>K</td> <td>4</td> <td>4</td> <td>4</td> <td>4</td> <td>4.5</td> <td>4.5</td> <td>4.5</td> <td>4.5</td> </tr> </table>	Dφ	4	5	6.3	8	10	13	16	18	F	1.5	2	2.5	3.5	5	5	7.5	7.5	C	4	4	4	4	4.5	4.5	4.5	4.5	K	4	4	4	4	4.5	4.5	4.5	4.5									
Dφ	4	5	6.3	8	10	13	16	18																																							
F	1.5	2	2.5	3.5	5	5	7.5	7.5																																							
C	4	4	4	4	4.5	4.5	4.5	4.5																																							
K	4	4	4	4	4.5	4.5	4.5	4.5																																							
KA	 <p>Fig1</p>	<table border="1"> <tr> <td>Dφ</td> <td>5</td> <td>6.3</td> <td>8</td> <td>10</td> <td>13</td> <td>16</td> <td>18</td> <td>22</td> </tr> <tr> <td>F</td> <td>2</td> <td>2.5</td> <td>3.5</td> <td>5</td> <td>5</td> <td>7.5</td> <td>7.5</td> <td>10</td> </tr> <tr> <td>E</td> <td>1.12</td> <td>1.12</td> <td>1.32</td> <td>1.32</td> <td>1.32</td> <td>1.32</td> <td>1.32</td> <td>1.82</td> </tr> <tr> <td>H1</td> <td>4</td> <td>4</td> <td>4</td> <td>4.5</td> <td>4.5</td> <td>4.5</td> <td>4.5</td> <td>4.5</td> </tr> <tr> <td>H2</td> <td>1.8</td> <td>1.8</td> <td>1.8</td> <td>1.8</td> <td>1.8</td> <td>1.8</td> <td>1.8</td> <td>1.8</td> </tr> </table>	Dφ	5	6.3	8	10	13	16	18	22	F	2	2.5	3.5	5	5	7.5	7.5	10	E	1.12	1.12	1.32	1.32	1.32	1.32	1.32	1.82	H1	4	4	4	4.5	4.5	4.5	4.5	4.5	H2	1.8	1.8	1.8	1.8	1.8	1.8	1.8	1.8
Dφ	5	6.3	8	10	13	16	18	22																																							
F	2	2.5	3.5	5	5	7.5	7.5	10																																							
E	1.12	1.12	1.32	1.32	1.32	1.32	1.32	1.82																																							
H1	4	4	4	4.5	4.5	4.5	4.5	4.5																																							
H2	1.8	1.8	1.8	1.8	1.8	1.8	1.8	1.8																																							

Part No. Code (15th, 16th)	Cutting & Forming	Size (mm)																																	
EF		<table border="1"> <tr> <td>Dφ</td> <td>4</td> <td>5</td> <td>6.3</td> <td>8</td> </tr> <tr> <td>F</td> <td>5</td> <td>5</td> <td>5</td> <td>5</td> </tr> <tr> <td>F1</td> <td>1.2</td> <td>1.2</td> <td>1.2</td> <td>1.2</td> </tr> <tr> <td>H1</td> <td>4</td> <td>4</td> <td>4</td> <td>4</td> </tr> <tr> <td>H2</td> <td>1.8</td> <td>1.8</td> <td>1.8</td> <td>1.8</td> </tr> </table>	Dφ	4	5	6.3	8	F	5	5	5	5	F1	1.2	1.2	1.2	1.2	H1	4	4	4	4	H2	1.8	1.8	1.8	1.8								
Dφ	4	5	6.3	8																															
F	5	5	5	5																															
F1	1.2	1.2	1.2	1.2																															
H1	4	4	4	4																															
H2	1.8	1.8	1.8	1.8																															
CR		<table border="1"> <tr> <td>Dφ</td> <td>4</td> <td>5</td> <td>6.3</td> <td>8</td> <td>10</td> <td>13</td> <td>16</td> <td>18</td> <td>22</td> <td>25</td> </tr> <tr> <td>F</td> <td>1.5</td> <td>2</td> <td>2.5</td> <td>3.8</td> <td>5</td> <td>5</td> <td>7.5</td> <td>7.5</td> <td>10</td> <td>12.5</td> </tr> <tr> <td>H1</td> <td>2.5</td> <td>2.5</td> <td>2.5</td> <td>2.5</td> <td>2.5</td> <td>2.5</td> <td>2.5</td> <td>2.5</td> <td>2.5</td> <td>2.5</td> </tr> </table>	Dφ	4	5	6.3	8	10	13	16	18	22	25	F	1.5	2	2.5	3.8	5	5	7.5	7.5	10	12.5	H1	2.5	2.5	2.5	2.5	2.5	2.5	2.5	2.5	2.5	2.5
Dφ	4	5	6.3	8	10	13	16	18	22	25																									
F	1.5	2	2.5	3.8	5	5	7.5	7.5	10	12.5																									
H1	2.5	2.5	2.5	2.5	2.5	2.5	2.5	2.5	2.5	2.5																									
CL		<table border="1"> <tr> <td>Dφ</td> <td>4</td> <td>5</td> <td>6.3</td> <td>8</td> <td>10</td> <td>13</td> <td>16</td> <td>18</td> <td>22</td> <td>25</td> </tr> <tr> <td>F</td> <td>1.5</td> <td>2</td> <td>2.5</td> <td>3.8</td> <td>5</td> <td>5</td> <td>7.5</td> <td>7.5</td> <td>10</td> <td>12.5</td> </tr> <tr> <td>H1</td> <td>2.5</td> <td>2.5</td> <td>2.5</td> <td>2.5</td> <td>2.5</td> <td>2.5</td> <td>2.5</td> <td>2.5</td> <td>2.5</td> <td>2.5</td> </tr> </table>	Dφ	4	5	6.3	8	10	13	16	18	22	25	F	1.5	2	2.5	3.8	5	5	7.5	7.5	10	12.5	H1	2.5	2.5	2.5	2.5	2.5	2.5	2.5	2.5	2.5	2.5
Dφ	4	5	6.3	8	10	13	16	18	22	25																									
F	1.5	2	2.5	3.8	5	5	7.5	7.5	10	12.5																									
H1	2.5	2.5	2.5	2.5	2.5	2.5	2.5	2.5	2.5	2.5																									
CS		<table border="1"> <tr> <td>Dφ</td> <td>4</td> <td>5</td> <td>6.3</td> <td>8</td> <td>10</td> <td>13</td> <td>16</td> <td>18</td> <td>22</td> <td>25</td> </tr> <tr> <td>F</td> <td>1.5</td> <td>2</td> <td>2.5</td> <td>3.8</td> <td>5</td> <td>5</td> <td>7.5</td> <td>7.5</td> <td>10</td> <td>12.5</td> </tr> </table>	Dφ	4	5	6.3	8	10	13	16	18	22	25	F	1.5	2	2.5	3.8	5	5	7.5	7.5	10	12.5											
Dφ	4	5	6.3	8	10	13	16	18	22	25																									
F	1.5	2	2.5	3.8	5	5	7.5	7.5	10	12.5																									
CZ		<table border="1"> <tr> <td>Dφ</td> <td>4</td> <td>5</td> <td>6.3</td> <td>8</td> <td>10</td> <td>13</td> <td>16</td> <td>18</td> <td>22</td> <td>25</td> </tr> <tr> <td>F</td> <td>1.5</td> <td>2</td> <td>2.5</td> <td>3.8</td> <td>5</td> <td>5</td> <td>7.5</td> <td>7.5</td> <td>10</td> <td>12.5</td> </tr> </table>	Dφ	4	5	6.3	8	10	13	16	18	22	25	F	1.5	2	2.5	3.8	5	5	7.5	7.5	10	12.5											
Dφ	4	5	6.3	8	10	13	16	18	22	25																									
F	1.5	2	2.5	3.8	5	5	7.5	7.5	10	12.5																									

Radial

Taping

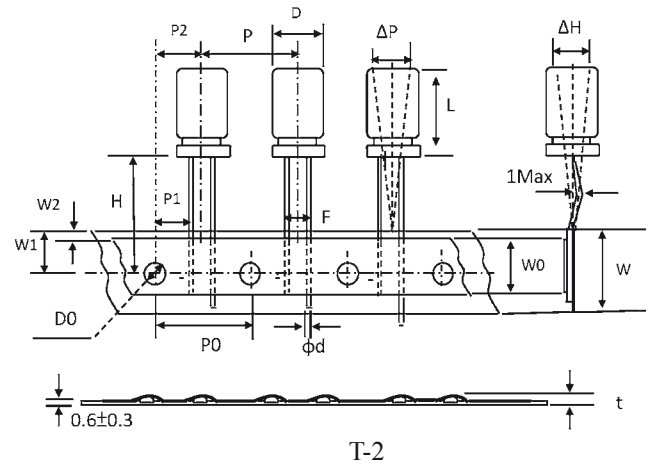
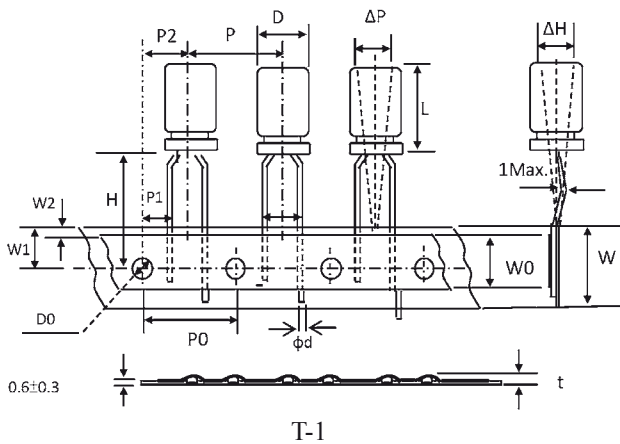

Specification Information

Code	D	L	d	P	P0	P1	P2	F	W	W0	W1	W2	H	D0	Δh	T1	t	code	Fig
Tol.	±0.5	Max	±0.02	±1.0	±0.2	±0.7	±1.3	$\frac{0.4}{-0.2}$	±0.5	±0.5	±0.5	Max	$\frac{0.75}{-0.5}$	±0.2	Max	±0.3	Max		
Item	4	5-7(+1)	0.45	12.7	12.7	$\frac{5.35}{5.1}$	6.35	$\frac{2}{2.5}$	18	11	9	2	18.5	4.0	1	0.6	1.5	TB TC	T-1
	5	$\frac{5-7(+1)}{9-15(±1.5)}$	$\frac{0.45}{0.5}$	12.7	12.7	4.6	6.35	2.5	18	11	9	2	18.5	4.0	1	0.6	1.5	TC	

Code	D	L	d	P	P0	P1	P2	F	W	W0	W1	W2	H	D0	Δh	ΔP	t	code	Fig
Tol.	±0.5	Max	±0.02	±1.0	±0.2	±0.7	±1.3	$\frac{0.4}{-0.2}$	±0.5	±0.5	±0.5	Max	$\frac{0.75}{-0.5}$	±0.2	Max	Max	Max		
Item	5	5-7(+1)	0.45	12.7	12.7	5.35	6.35	2.0	18	11	9	2.0	18.5	4.0	1	-	1.5	TB	T-2
		$\frac{5-7(+1)}{9-15(±1.5)}$	$\frac{0.45}{0.5}$															TC	
	6.3	5(+1)	0.45	12.7	12.7	5.1	6.35	2.5	18	11	9	2.0	18.5	4.0	1	-	1.5	TC	
		7(+1)	0.5															TC	
$\frac{10(+1)^*}{9-15(±1.5)}$		$\frac{0.6}{0.5}$	TC																
Item	8	5-7(+1)	0.5	12.7	12.7	4.6	6.35	3.5	18	11	9	2.0	18.5	4.0	1	-	1.5	TD	
		8(+1)*	0.6															TA	
		$\frac{11.5(+1.5)^*}{9-20(±1.5)}$	$\frac{0.6}{0.5}$															TA	
		$\frac{9-20(±1.5)}{9-20(±1.5)}$	$\frac{0.6}{0.5}$															TA	
10	9-30(±1.5)	0.6	12.7	12.7	3.85	6.35	5.0	18	11	9	2.0	18.5	4.0	1	-	1.5	TA		
13	13-40(±1.5)	0.6	15	15	5	7.5	5.0	18	15	9	2.0	18.5	4.0	2	-	1.5	TA		

* : In this case, that is suitable for polymer.

Taping

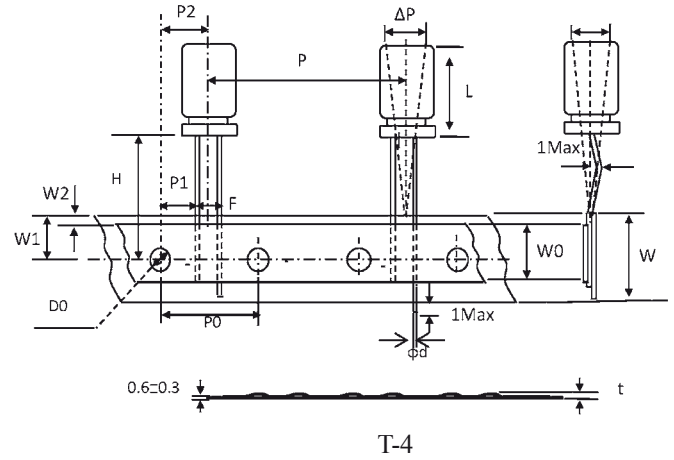
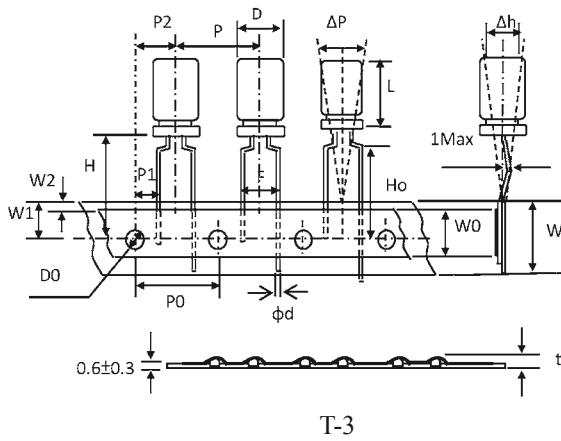

Specification Information

Code	D	L	d	P	P0	P1	P2	F	W	W0	W1	W2	H	H0	D0	Δh	ΔP	t	code	Fig
Tol.	±0.5	Max	±0.02	±1.0	±0.2	±0.3	±1.0	$\frac{0.4}{-0.2}$	±0.5	±0.5	±0.5	Max	$\frac{0.75}{-0.5}$	±0.5	±0.2	Max	Max	Max		
Item	4	5-7(+1)	0.45	12.7	12.7	3.85	6.35	5	18	11	9	2.0	18.5	16	4.0	1	1	1.5	TA	T-3
	5	5-7(+1)	0.45	12.7	12.7	3.85	6.35	5	18	11	9	2.0	18.5	16	4.0	1	1	1.5		
		9-15(±1.5)	0.5																	
	6.3	5(+1)	0.45	12.7	12.7	3.85	6.35	5	18	11	9	2.0	18.5	16	4.0	1	1	1.5		
		7(+1)	0.5																	
		10(+1)*	0.6																	
		9-15(±1.5)	0.5																	
8	5-8(+1)	0.5	12.7	12.7	3.85	6.35	5	18	11	9	2.0	18.5	16	4.0	1	1	1.5			
	9-20(±1.5)	0.5																		

Code	D	L	d	P	P0	P1	P2	F	W	W0	W1	W2	H	D0	Δh	l	t	code	Fig
Item	±0.5	±1.5	±0.02	±1.0	±0.2	±0.7	±1.3	$\frac{0.4}{-0.2}$	±0.5	±0.5	±0.5	Max	$\frac{+0.75}{-0.5}$	±0.2	Max	Min	Max		
	13	13~40(±1.5)	0.6	25.4	12.7	3.85	6.35	5	18	15	9	2.0	18.5	4.0	2	1	1.5	TA	T-4
	16	16~40(±1.5)	0.8	30	15	3.75	7.5	7.5	18	15	9	2.0	18.5	4.0	2	1	1.5	TE	

* : In this case, that is suitable for polymer.

Part Number Ammo Package

F	5	2	2.5	3.5	7.5	SMD
Code (15th, 16th)	TA	TB	TC	TD	TE	TR

Part Number Reel Package

F	5	2	2.5	3.5	7.5
Code (15th, 16th)	RA	RB	RC	RD	RE

Package Information

Size $\phi D \times L$ (mm)	Ammo Package			Size $\phi D \times L$ (mm)	Reel Package	
	W	A	Quantity (pcs)		AW	Quantity (pcs)
4 x all	227	51	2500	4 x all	45	1800
5 x all	227	51	2000	5 x all	45	1300
6.3 x all	227	51	1500	6.3 x all	45	1000
8 x 5~16	227	51	800	8 x 5~17	45	800
8 x 17~25	191	57	800	8 x 18~28	55	800
10 x 7~15	227	51	600	10 x 7~17	45	600
10 x 16~20	191	57	500	10 x 18~28	55	600
10 x 21~25	190	60	500	13 x 13~17	45	300
13 x 13~15	227	51	300	13 x 18~28	55	300
13 x 16~20	191	57	300	16 x 13~17	45	200
13 x 21~25	190	60	300	16 x 18~28	55	200
13 x 26~30	216	64	300			
16 x 16~20	191	57	200			
16 x 21~25	216	64	200			
16 x 26~30	254	67	250			
16 x 31~35.5	230	71	250			

Ammo Package

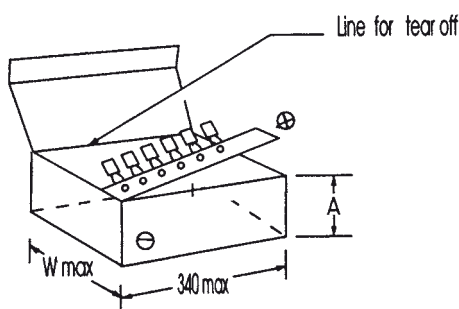

Reel Package

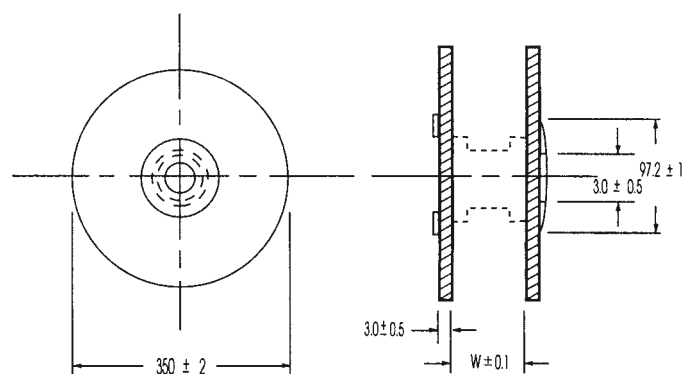

Available terminal for Snap-in Type

Please consult us about terminal type other those blow listed.

1. Standard terminal type

Terminal code:PP

D=Φ22 to Φ40

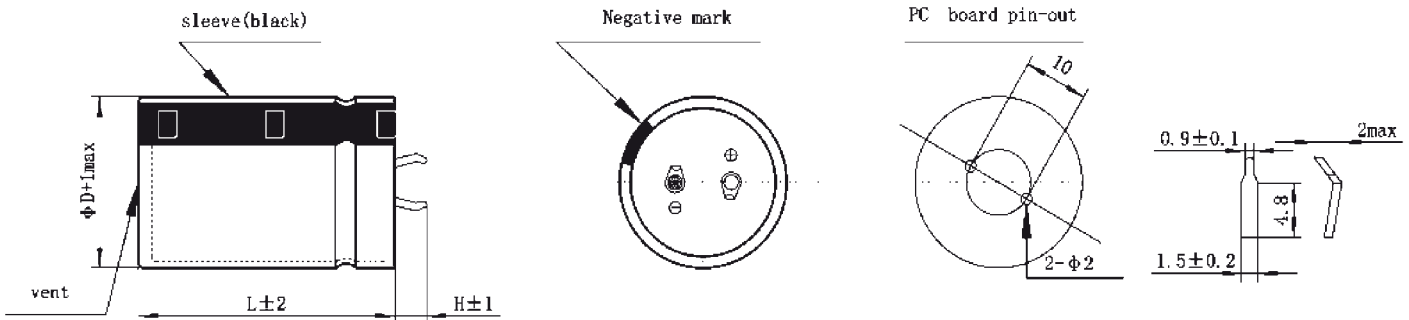

Standard snap-in terminals:Length 6.0±1mm.Also available with length of 4.0±1mm

2. Vibration proof terminal T type

Terminal code:CP

D=Φ30 to Φ40

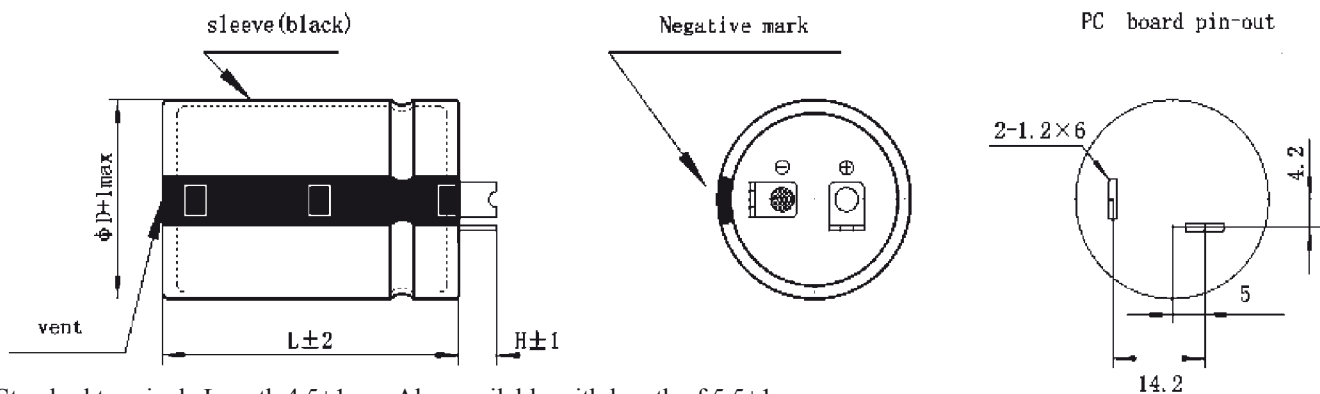

Standard terminals:Length 4.5±1mm.Also available with length of 5.5±1mm

3. Soldering Type terminal

Terminal code:VP

D=Φ30 to Φ40

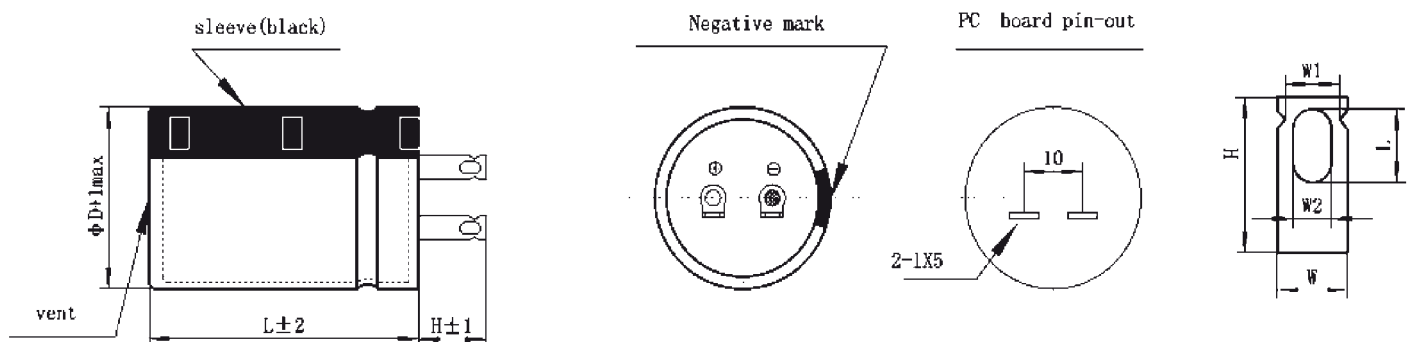

Standard terminals:Length 6±1mm.Also available with length of 5.0±1mm or 12.0±1mm

4. Vibration proof terminal U type

Terminal code:HP

D=Φ30 to Φ40

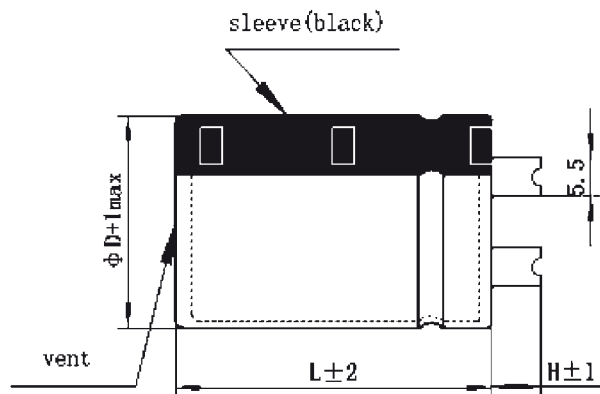

Negative mark

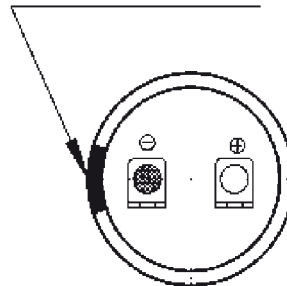

PC board pin-out

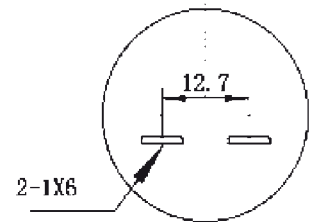

Standard terminals: Length $6 \pm 1 \text{ mm}$.

5. Long terminal for Left or right bending type

Terminal code:HP

D=Φ30 to Φ40

Left bending(C+L):

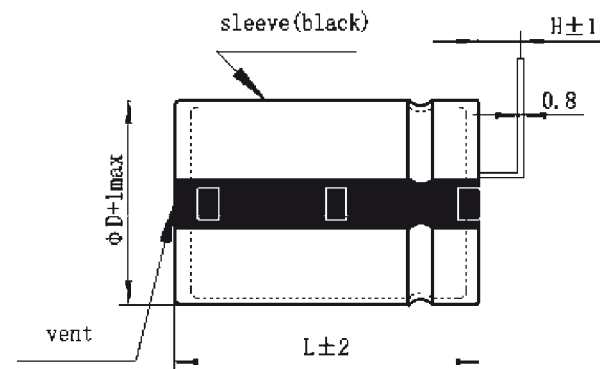

Negative mark

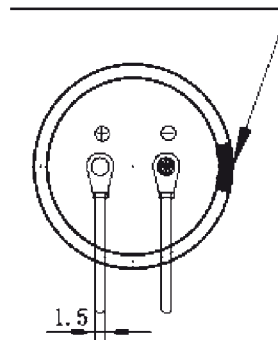

PC board pin-out

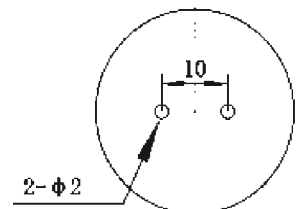

Right bending(C+R):

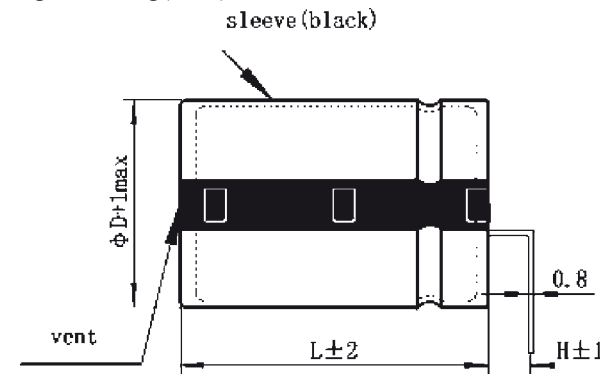

Negative mark

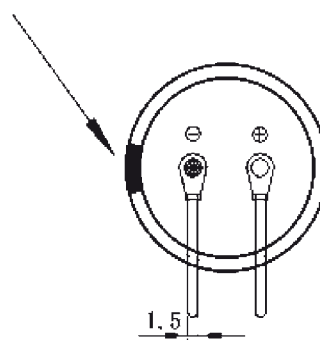

PC board pin-out

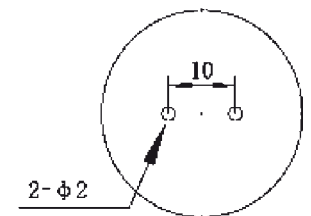

Standard terminals: H Length $2.5 \pm 1 \text{ mm}$.

6. Slim terminal type

Terminal code:LP

D=Φ22 to Φ40

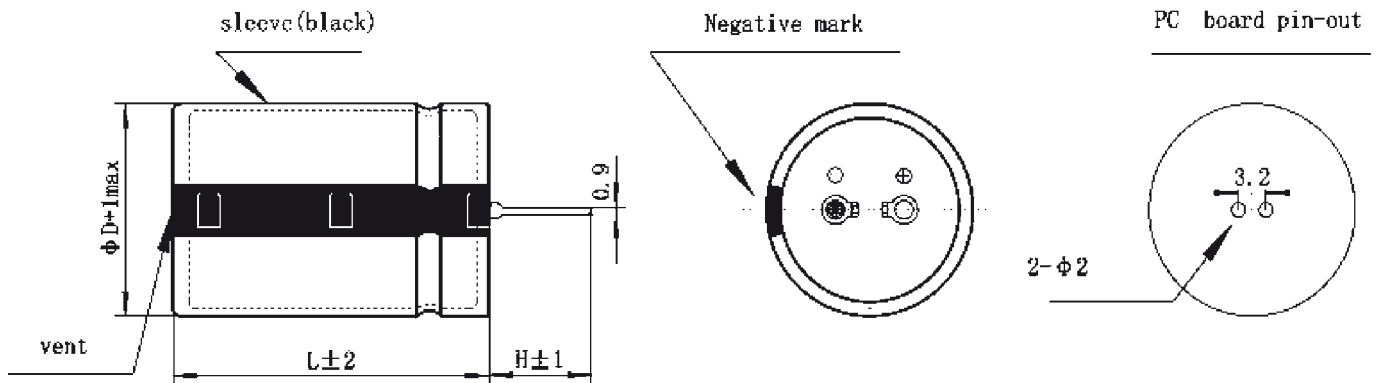

Standard terminals:Length 9.5±1mm. Also available with length of 4.0±1mm.

7. 3pin snap-in terminal type

Terminal code:ZP

D=Φ22 to Φ40

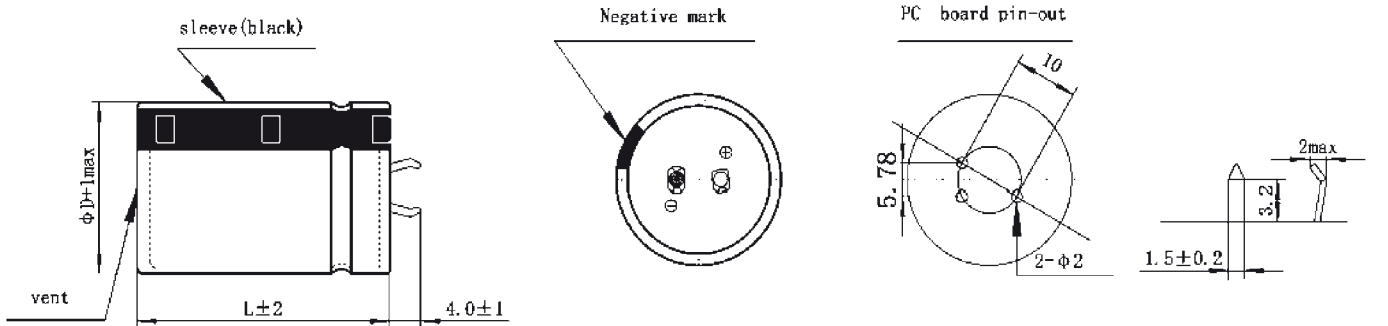

8. 4pin snap-in terminal type

Terminal code:YP

D=Φ30 to Φ40

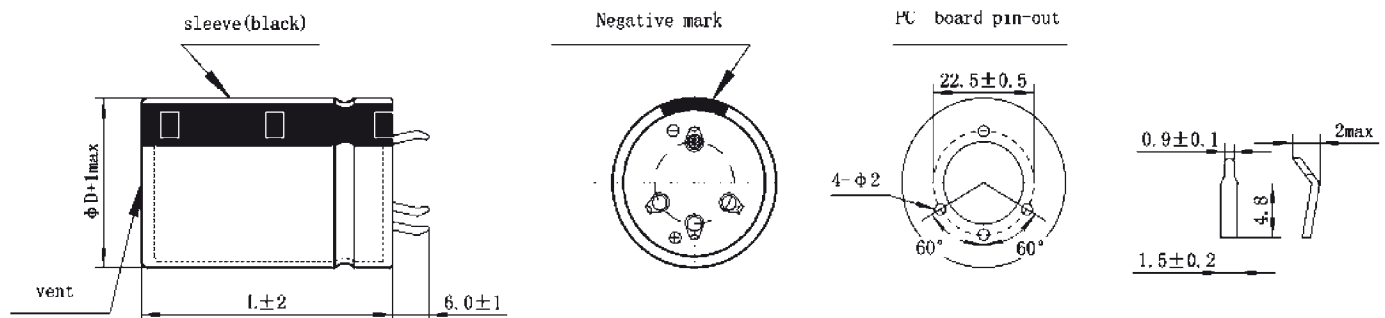

Package for Snap-in type

Packing

Capacitor diameter D(mm)	Length L(mm)	Terminal length H(mm)	Each carton packing Qty units(pcs.)	Box/carton units(pcs.)	Each box packing Qty units(pcs.)
20	all	/	720	6	120
22	all	/	600	6	100
25	all	/	500	5	100
30	≤36	<6	400	8	50
30	≥36	≥6	300	6	50
35	<27	/	400	8	50
35	27≤L≤42	/	300	6	50
35	>42	/	200	4	50
40	<37	/	200	5	40
40	37≤L<47	/	160	4	40
40	≥47	/	120	3	40

Packing of Snap-in



Carrier tape

4φ~10φ:

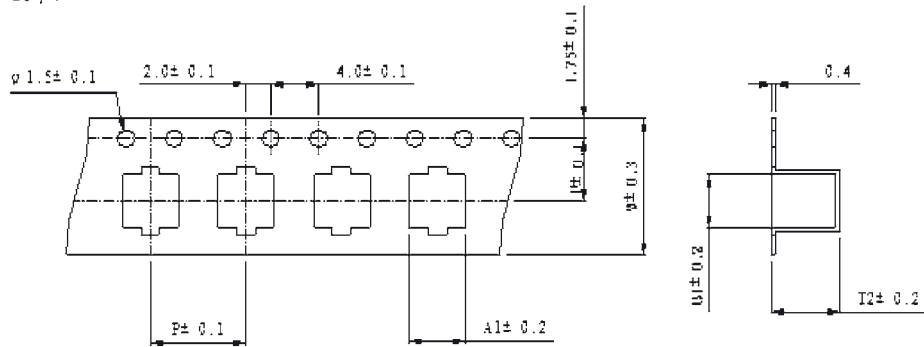

12.5φ~16φ:

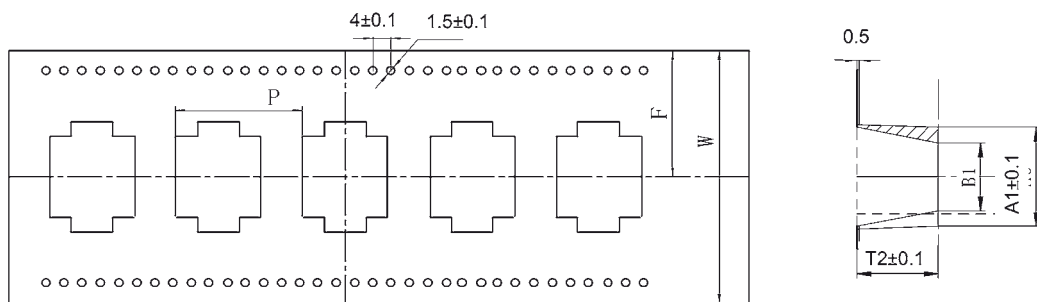

Unit: mm

φD	4x5.5	5x5.5	6.3x6.1	6.3x5.5	6.3x5.8	6.3x7.7	8x6.5	8x7.7	8x10.5	8x11.7	10x8.7	10x10.5	10x12.4	12.5X14	16X17
W	12.0	12.0	16	16.0	16.0	16.0	16	16	24.0	24.0	24	24.0	24.0	32	44
P	8.0	12.0	12	12.0	12.0	12.0	12	12	16.0	16.0	16	16.0	16.0	24	28
F	5.5	5.5	9.25	7.5	7.5	7.5	7.5	7.5	11.5	11.5	11.5	11.5	11.5	16	21.95
A ₁	4.7	5.7	7	7.0	7.0	7.0	8.7	8.7	8.7	8.7	10.7	10.7	10.7	13.9	19.5
B ₁	4.7	5.7	7	7.0	7.0	7.0	8.7	8.7	8.7	8.7	10.7	10.7	10.7	13.9	17.5
T ₂	5.7	5.7	6.2	5.7	5.7	8.0	7.0	8.2	11.0	11.0	8.2	11.0	12.9	14.5	17.3

Reel

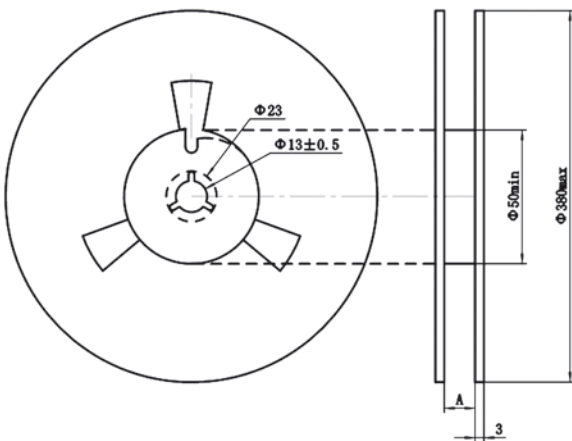

Dφ	4	5	6.3, 8	8, 10	12.5	16
A	14	14	18	26	34	46

φD	Quantity
4X5.5	2000pcs
5x5.5	1000pcs
6.3x6.1	1000pcs
6.3x5.5	1000pcs
6.3x5.8	1000pcs
6.3x7.7	900 pcs
8x6.5	1000pcs
8x7.7	700pcs
8x10.5	500pcs
8x11.7	400pcs
10x8.7	700pcs
10x10.5	500pcs
10x12.4	400pcs
12.5X14	200pcs
16X17	125pcs

For Conductive Polymer Capacitors

CP-CAP is a solid aluminum capacitor with conductive polymer electrolyte. Please read the following points in order to take the most out of your CP-CAP.

Designing device circuits

1. Circuits where CP-CAPs are prohibited to used

The leakage current of conductive polymer solid aluminum capacitors may vary depending on thermal stresses. Please don't use solid capacitors in the following types of circuits:

- (1) High-impedance circuits that are to sustain voltages.
- (2) Coupling circuits
- (3) Time constant circuits

In addition to the leakage current fluctuation, capacitance may also fluctuate depending on operational temperature and humidity. The fluctuation of the capacitance may cause problem if it is used as a time constant capacitor, which is extremely sensitive to the fluctuation of the capacitance. Do not use it as a time constant capacitance.

- (4) Other circuits that are significantly affected by leakage current. If you want to use 2 or more CP-CAPs in a series connection, please contact us before use.

2. Polarity

The CP-CAP is a polarized solid aluminum electrolytic capacitor. Do not apply either reverse voltages or AC voltages to the polarized capacitors, using reverse polarity may cause a short circuit. Refer to the catalog, product specifications or capacitor body to confirm the polarity prior to use.

3. Applied voltage

Do not apply DC voltages exceeding the full rated voltage. The peak voltage of superimposed AC voltages (ripple voltages) on DC voltages must not exceed the full rated voltage. While there are specifications for surge voltages exceeding the rated voltage, usage conditions apply, and continued operation for extended periods of time under such conditions cannot be guaranteed. Use the within 20% of the rated voltage for applications which may cause the reverse voltage during the transient phenomena when the power is turned off or the source is switched.

4. Ripple current

Do not apply currents in excess of the rated ripple current. The superimposition of a large ripple current increases the rate of heating within the capacitor. This may reduce the service life of the capacitor or damage the capacitor.

5. Operating temperature

Do not use the CP-CAP at high temperatures (temperatures exceeding the maximum temperature for the capacitor category) Use of the capacitor outside of the maximum temperature for the capacitor category may decrease the service life of the capacitor.

6. Sudden charge and discharge

Do not use the CP-CAP in circuits where the capacitor is repetitively charged and discharged rapidly. Repetitively charging and discharging the capacitor rapidly may reduce the capacitance or may cause damage due to internal heating. Use of a protective circuit to ensure reliability is recommended when rush currents exceed 10A or the rush current is over 10 times of allowable ripple current of CP-CAP.

A protection resistor(1 kΩ) must be inserted to the circuit during the charge and discharge when measuring the leakage current.

7. Failures and life-span

The CP-CAP failure rate in use is based on the failure rate level in the specification requirements. Upper category temperature and category voltage adhere to JIS C 5003 Standard. The confidence level is 60% and the failure rate is 0.5%/1,000 hours (applied rated voltage at category temperature).

The failure modes mainly have 2 types as follows.

(1) Contingency failure

The contingency failure mainly has short circuit. The phenomenon of after short is on following.

- (i) In the event a short circuit causes the current to become relatively small(less than approximately 1A for φ10, less than approximately 0.5A for φ8 and less than approximately 0.2A for smaller than φ6.3),the CP-CAP itself will generate a little heat, but its appearance will not be affected even when electricity is supplied continuously. However, if the short circuit current value exceeds the mentioned values above, the temperature inside the CP-CAP will increase, the internal pressure is

raised, rubber sealing is turned over, and odorous gas is released. In this case, keep your face and hands away from the area.

(ii) The electrolyte, electrolytic paper, sealing rubber, and plastic spacer used in the CP-CAP are all combustible. If an extremely large electric current flows through the capacitor after shorting, the shorted part may spark, and in a worst case scenario, may ignite. Ensure safety by fully considering the design issues described below when using this capacitor in equipment where safety is a priority.

- Increase safety by using in conjunction with a protective circuit or protective equipment.
- Install measures such as redundant circuits so that the failure of a part of the equipment will not cause unstable operation.

(2) Performance characteristic and failure(life-span)

CP-CAP characteristics can possibly change(capacitance reduction and ESR increase) within the specified range in specifications when it is used in the condition of rated voltage, electric and mechanical performance.

When life span exceeded the specified guarantee time of endurance and damp heat, electric characteristic might change and cause electrolyte insulation. This is called open circuit mode. It is recommended to use the capacitor at a lower temperature than the maximum temperature for the capacitor category.

8. Circuit design

Verify the following before designing the circuit:

- (1) The electrical characteristics of the capacitor will vary depending on differences in temperature and frequency. Only design your after verifying the scope of these factors.
- (2) When connecting two or more capacitors in parallel, ensure that the design takes current balancing into account.
- (3) When two or more capacitors are connected in series, variability in applied voltage may cause over-voltage conditions. Contact CapXon before using capacitors connected in series.

9. Capacitor usage environment

Do not use/expose capacitors to the following conditions.

- (1) Oil, water, salty water, take care to avoid storage in damp locations.
- (2) Direct sunlight
- (3) Toxic gases such as hydrogen, sulfide, sulfurous acids, nitrous acids, chlorine and chlorine compounds, bromine and bromine compounds, ammonia, etc.
- (4) Ozone, ultraviolet rays and radiation.
- (5) Severe vibration or mechanical shock conditions beyond the limits advised in the product specification section of the catalog.

10. Capacitor mounting

- (1) For the surface mount capacitor, design the copper pads on the PC board in accordance with the catalog or the product specification
- (2) For radial capacitors, design the terminal holes on the PC board to fit the terminal pitch of the capacitor.

11. Leakage current

Heat pressure from soldering and mechanical stress from transportation may cause the leakage current to become large. In such a case, leakage current will gradually decrease by applying voltage less than or equal to the rated voltage at a temperature within the upper category temperature. In close conditions to the upper category temperature, the nearer the applied voltage is to the rated voltage, the faster the leakage current recovery speed is.

Mounting precautions

1. Note

- (1) For the surface mount capacitor, design the copper pads on the PC board in accordance with the catalog or the product specification
- (2) For radial capacitors, design the terminal holes on the PC board to fit the terminal pitch of the capacitor.
- (3) Mount after checking the capacitance and the rated voltage.
- (4) Mount after checking the polarity.
- (5) Do not apply excessive external force to the lead terminal and the CP-CAP itself.
- (6) Ensure that the soldering conditions meet the specifications recommended by CapXon. Note that the leakage current may increase due to thermal stresses that occur during soldering, etc. Note that increased leakage currents gradually decrease when voltage is

applied.

2. Soldering using a soldering iron:

- (1) The soldering conditions (temperature and time) are within the ranges specified in the catalog or product specifications.
- (2) The tip of the soldering iron does not come into contact with the capacitor itself.

3. Flow soldering

- (1) Do not dip the body of a capacitor into the solder bath only dip the terminals in. The soldering must be done on the reverse side of PC board.
- (2) Soldering conditions (preheat, solder temperature and dipping time) should be within the limits prescribed in the catalog or the product specifications.
In regards to flow soldering, be sure to solder within the following conditions.

	Temperature	Duration	Flow number
Preheating	120°C or less (ambient temperature)	120 sec. or less	1 time
Soldering conditions	260+5°C or less	10+1 sec. or less	Twice or less

- (3) Do not apply flux to any part of capacitors other than their terminals.
- (4) Make sure the capacitors do not come into contact with any other components while soldering.

4. Reflow soldering

- (1) Soldering conditions (preheat, solder temperature and soldering time) should be within the limits prescribed in the catalogs or the product specification.
- (2) The heat level should be appropriate. (Note that the thermal stress on the capacitor varies depending on the type and position of the heater in the reflow oven.)
- (3) Vapor phase soldering (VPS) is not used.
- (4) Except for the surface mount type, reflow soldering must not be used for the capacitors.
- (5) In the case of reflow soldering, capacitive static electricity may decrease after soldering even when the soldering conditions are within the required values.
- (6) Recommended reflow condition of SMD type.

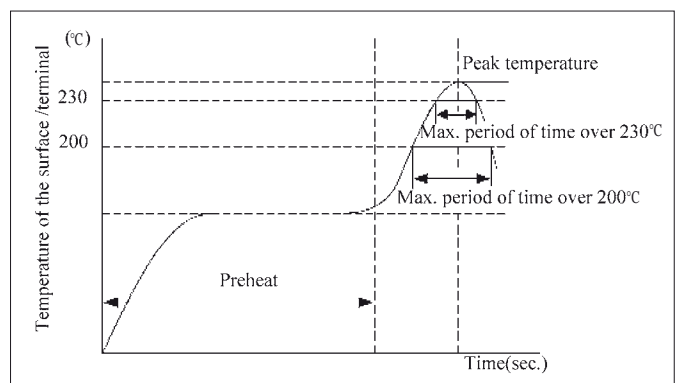

Voltage range	Preheat	Time maintained above 200°C	Time maintained above 230°C	Peak temp.	Reflow number
2.5 to 10v	150 to 180°C 120 sec. max.	90 sec. max.	60 sec. max.	260°C max	only 1 time
16 to 25v				90 sec. max.	60 sec. max.
		80 sec. max.	50 sec. max.	240°C max	twice or less
35 to 50v		70 sec. max.	30 sec. max.	240°C max	only 1 time

Note : 1) All temperatures are measured on the topside of the Al-case and terminal surface.
2) The second reflow soldering shall be applied after the temperature of capacitors decreases down to the room temperature.

The leakage current value may increase (from a few μA to a few mA) even within the above conditions. When the CP-CAP is used in a DC circuit, the leakage current will decrease gradually through self-recovery after voltage is applied. If your reflow profile deviates from the above conditions for mounting the CP-CAP, please consult with CapXon.

5. Handling after soldering

Do not apply any mechanical stress to the capacitor after soldering onto the PC board.

- (1) Do not lean or twist the body of the capacitor after soldering the capacitors onto the PC board
- (2) Do not use the capacitors for lifting or carrying the assembly board.
- (3) Do not hit or poke the capacitor after soldering to PC board. When stacking the assembly board, be careful that other components do not touch the aluminum electrolytic capacitors.
- (4) Do not drop the assembled board.

6. Washing the PC boards

- (1) Do not wash capacitors by using the following cleaning agents. Solvent resistant capacitors are only suitable for washing using the cleaning conditions prescribed in the catalog or the product specification. In particular, ultrasonic cleaning will accelerate damage to capacitors.

- Halogenated solvents; cause capacitors to fail due to corrosion.
Alkali system solvents; corrode (dissolve) an aluminum case.
- Petroleum system solvents; cause the rubber seal material to deteriorate.
- Xylene; causes the rubber seal material to deteriorate.
- Acetone; erases the markings.

- (2) Verify the following points when washing capacitors.

- Monitor conductivity, pH, specific gravity and the water content of cleaning agents. Contamination adversely affects these characteristics.
- Be sure not to expose the capacitors under solvent rich conditions or keep capacitors inside a closed container. In addition, please dry the solvent

sufficiently on the PC board and the capacitor with an air knife (temperature should be less than the maximum rated category temperature of the capacitor) for 10 minutes. Aluminum electrolytic capacitors can be characteristically and catastrophically damaged by halogen ions, particularly by chlorine ions, though the degree of the damage mainly depends upon the characteristics of the electrolyte and rubber seal material. When halogen ions come into contact with the capacitors, the foil corrodes when a voltage is applied. This corrosion causes an extremely high leakage current which results venting and an open circuit.

Storage

The following conditions for storage are recommend.

- (1) Store capacitors in a cool, dry place. Store at a temperature between 5 and 35°C, with a humidity of 75% or less. SMD products are sealed in a special laminated aluminum bag. Use all capacitors once the bag is opened. Return unused capacitors to the bag, and seal it with a zipper. Be sure to follow our recommendations for reflow soldering.
- (2) Store the capacitors in a location free from direct contact with water, salt water, and oil.
- (3) Store in a location where the capacitor is not exposed to toxic gas, such as hydrogen sulfide, sulfurous acid, nitrous acid, chlorine or chlorine compounds, bromine or other halogen gases, methyl bromide or other halogen compounds, ammonia, or similar.
- (4) Store in a location where the capacitor is not exposed to ozone, ultraviolet radiation, or other radiation.
- (5) It is recommended to store capacitors in their original packaging wherever possible.

For Aluminum Electrolytic Capacitors

When you use aluminum electrolytic capacitors, remember the following.

1. Polarity

- Regular electrolytic Capacitor has polarity.
- Reverse voltage causes short circuit breakage of the capacitor or leakage of electrolyte. Where the polarity in a circuit sometimes reversed or unknown, a bi-polar capacitor should be used.

2. Overvoltage

- Do not apply overvoltage continuously.
- When overvoltage is applied to the capacitor, leakage current increase drastically.
- Applied working voltage to capacitors should not exceed the rated working voltage of capacitor.

3. Operating temperature and life:

- Do not use the capacitor over the max operating temperature.
- Life time of the capacitor depends on the temperature.
- Generally, life time is doubled by decreasing each temperature 10°C.
- Use temperature as low as possible.

4. Vent

- It is recommended at least 3mm of space around the vent.
- If such space is not provided, the vent will not operate completely.

5. Ripple current

- Do not apply a ripple current exceeding the rated maximum ripple current.
- Applying too much ripple current to the capacitor causes great heat generation, invites deterioration of properties of cases breakage.
- Please consult factory if ripple current exceeds the specified limit.

6. Charge and discharging

- Frequent and quick charge/discharge generates heat inside the capacitor, causing increase of leakage current, decrease of capacitance, or breakage occasionally.
- Consult us for assistance in this application.

使用鋁電解電容器注意事項：

1. 極性

鋁電解電容器一般是有極性的，極性反接是造成鋁電解電容器短路損壞及漏液的原因，因此在無法辨識電氣迴路上之極性或使用於有極性變換設計之迴路時，請選用無極性電解電容器。

2. 過載

請勿連續施加過載電壓。當電壓過載時電解電容器的漏電流會急速增加，所以電解電容器之工作電壓不應超過額定值。

3. 使用溫度和壽命

電解電容器之使用溫度請勿超出最高使用溫度之設定範圍。電解電容器的壽命取決於使用溫度，一般來說當電解電容器之使用溫度降低10°C時，其壽命將增為兩倍，因此電解電容器應儘可能在較低溫度下使用。

4. 防爆孔

有防爆孔設計之電解電容器其使用時防爆孔側應與其它機構保持最少3mm以上之空間距離，如此條件不能滿足的話，防爆孔將無法正常運作。

5. 紋波電流

請勿施加超過額定最高紋波電流容許值以上之紋波電流。施加過大紋波電流將使電解電容器的內溫異常上升，引起電解電容器電氣特性劣化及破損。如有需要施加額定值以上之紋波電流等要求時，請諮詢敝廠人員。

6. 充放電

經常及快速的充放電將使電容器之內溫異常上升，使漏電流增加、容量降低，有時還會造成產品之損壞，如對充放電有特殊要求時請諮詢敝廠人員。

7.Storage

- When the capacitor is stored for a long time without applying voltage, leakage current tends to increase.
- This returns to normal by applying the rated voltage to the capacitor before use.
- It is recommended to apply D.C. working voltage to the capacitor for 30 minutes through 1K Ω of protective series resistor, if it is stored for more than 6 months.
- The capacitor should be stored at a normal temperature and humidity.

8.Soldering

- Improper soldering may shrink or break the insulating sleeve and/or damage the internal element as terminals and lead wires conduct heat into the capacitor.
- Avoid too high a soldering temperature and/or too long a soldering time.

9.Mechanical stress on the lead wire and the terminal

- Do not apply excessive force to the lead wire and the terminal.
- Do not move the capacitor after soldering to the PC board, not carry the PC board by picking up the capacitor. For their strength, refer to JIS C-5141 and C-5102.

10.Cleaning of boards after soldering

- If the capacitor is cleaned in halogenated solvent for organic removing solder flux solvent, the solvent may penetrate into the inside of capacitor, and may generate corrosion.

11.Sleeve material

- The standard sleeve material is polyvinyl-chloride.
- If exposed to xylene, toluene, etc, and then subjected to high heat, the sleeve may crack. This sleeve is not insulating material.

12.CapXon's Products meet quality standards specified by JIS-C-5101-1 and the reliability requirements refer to JIS-C-5101-4(non-SMD liquid capacitor), -18(Liquid SMD capacitor), -25(solid SMD capacitor),-26(solid Radial capacitor).

13.None of ozone depleting chemicals (ODC) under the Montreal Protocol is used in manufacturing process of CapXon Electronic Industrial CO., Ltd.

7.電解電容器的儲存

當電解電容器經過長時間之放置後，通常其漏電流有增大之傾向。因此在使用經過長時間放置後之電解電容器以前，需先施加定額電壓使其電氣特性回復正常；如儲存時間長於6個月以上時，請串排1k Ω 之保護電阻後，使其持續負載定額工作電壓30分鐘。另外電解電容器應儲存於常溫及常濕之環境下。

8.焊錫

不適當的焊錫溫度及時間可能造成表面膠管之異常收縮破裂，有時高溫也會藉由導針及端子導熱至電子內部，對產品造成不良影響，因此須盡量避免過高溫度及過長時間之焊錫。

9.導針與端子之機械強度

請勿施加過度之外力於導針及端子上。請勿扳開已焊接於PC板上之電解電容器，更不要以電解電容器為施力點提起或移動整塊PC板。

10.焊錫後之基板清洗

如使用鹵化有機溶劑清洗基板，溶劑有可能滲進電解電容器內部引起腐蝕。

11.套管材料

一般使用之塑膠套膠材質多為聚氯乙烯(PVC)，如塑膠管在浸漬二甲苯或甲苯後再放置於高溫下，將產生破裂現象也同時失去了絕緣之功能。

12.本公司之產品品質符合JIS-C-5101-1指定標準，其信賴性試驗方法依JIS-C-5101-4(非SMD液態電容)，-18(液態SMD電容)，-25(固態SMD電容)，-26(固態導針型電容)之規範為基準。

13.本公司依蒙特利爾協議書之規定，於生產過程中不使用破壞臭氧層之藥品。

PL series Low ESR $\leq 9m\Omega$

Features

- ◆ Very Low ESR at high frequency range.
- ◆ Very Large permissible ripple current.



Specifications

Item	Performance Characteristics	
Operating Temperature Range	-55~+105°C	
Rated Voltage Range	2.5~16 VDC	
Capacitance Range	180 to 3500 μ F	
Capacitance Tolerance	$\pm 20\%$ (120Hz,+20°C)	
Leakage Current (+20°C,max.)	$\leq 0.2CV$ (μ A, after 2 minutes)	
Dissipation Factor (tan δ , at 20°C , 120Hz)	Not to exceed the value specified	
ESR (100K~300KHz)	Not to exceed the value specified	
Endurance 105°C , 2000h , at rated voltage	Capacitance	Within $\pm 20\%$ of the value before test
	Leakage current	Not to exceed the value specified
	ESR	Not to exceed 150% of the value specified
	Dissipation Factor	Not to exceed 150% of the value specified
Moisture Resistance Stored at 60°C , RH90~95% , 1000h	Capacitance	Within $\pm 20\%$ of the value before test
	Leakage current	Not to exceed the value specified
	ESR	Not to exceed 150% of the value specified
	Dissipation Factor	Not to exceed 150% of the value specified

Frequency Coefficient for Ripple Current

Frequency	120Hz \leq freq. < 1KHz	1KHz \leq freq. < 10KHz	10KHz \leq freq. < 100KHz	100KHz \leq freq. < 300KHz
Coefficient	0.05	0.3	0.7	1

Diagram of Dimensions:(unit:mm)

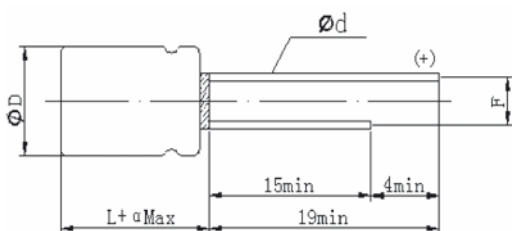

$\phi D \times L$	$\phi D + 0.5\text{max.}$	α	$F \pm 0.5$	$\phi d \pm 0.05$
8 \times 8	8.0	1.0	3.5	0.6
8 \times 11.5	8.0	1.5	3.5	0.6
10 \times 12.5	10.0	1.5	5.0	0.6

Dimensions & Characteristics

φ D×L(mm)

W.V. (V)	Capacitance (μF)	L.C. (μA,2min)	tg δ (120Hz,20°C)	ESR (mΩ,100KHz)	Maximum Permissible Ripple Current(mA,r.m.s)	Size ΦD×L(mm)
2.5	560	280	0.08	9	6100	8×8 8×11.5
	680	340	0.08	9	6100	8×8 8×11.5
	820	410	0.08	9	6100	8×8 8×11.5
	1000	500	0.08	9	6100	8×8 8×11.5
	1200	600	0.08	9	6100	8×8 8×11.5
	1500	750	0.08	9	6100	8×8 8×11.5
	2000	1000	0.08	9	6100 6640	8×11.5 10×12.5
	2500	1250	0.08	9	6640	10×12.5
	2700	1350	0.08	9	6640	10×12.5
	3000	1500	0.08	9	6640	10×12.5
	3300	1650	0.08	9	6640	10×12.5
	3500	1750	0.08	9	6640	10×12.5
	4	560	224	0.08	9	6100
680		272	0.08	9	6100	8×8 8×11.5
820		328	0.08	9	6100	8×8 8×11.5 10×12.5
1000		800	0.08	9	6100	8×8 8×11.5
1200		960	0.08	9	6100 6640	8×11.5 10×12.5
1500		1200	0.08	9	6100	8×11.5 10×12.5
2000		1600	0.08	9	6640	10×12.5
2500		1500	0.08	9	6640	10×12.5
6.3		180	226.8	0.07	9	6100
	220	277	0.07	9	6100	8×8 8×11.5
	270	340.2	0.07	9	6100	8×8 8×11.5
	330	416	0.07	9	6100	8×8 8×11.5
	390	491.4	0.08	9	6100	8×8 8×11.5
	470	592	0.08	9	6100	8×8 8×11.5
	560	705.6	0.08	9	6100	8×8 8×11.5
	680	428.4	0.08	9	6100	8×8 8×11.5
	820	516.6	0.10	9	6100 6100	8×8 8×11.5
	1000	630	0.10	9	6100 6640	8×11.5 10×12.5
	1200	756	0.10	9	6100 6640	8×11.5 10×12.5
	1500	945	0.10	9	6100 6640	8×11.5 10×12.5
	2000	1260	0.10	9	6640	10×12.5
	2200	1336	0.10	9	6640	10×12.5
	2500	1575	0.10	9	6640	10×12.5

Ripple Current (mA, rms) at 105°C, 100KHz

Conductive Polymer

W.V. (V)	Capacitance (μ F)	L.C. (μ A,2min)	tg δ (120Hz,20°C)	ESR (m Ω ,100KHZ)	Maximum Permissible Ripple Current(mA,r.m.s)	Size Φ D \times L(mm)
10	180	360	0.07	9	6100	8 \times 8
					5600	8 \times 11.5
	220	440	0.08	9	6100	8 \times 8
					5600	8 \times 11.5
	270	540	0.08	9	6100	8 \times 8
					5600	8 \times 11.5
	330	660	0.08	9	6100	8 \times 8
					5600	8 \times 11.5
	390	780	0.08	9	6100	8 \times 8
					5600	8 \times 11.5
	470	940	0.08	9	6100	8 \times 8
					5600	8 \times 11.5
	560	560	0.10	9	6100	8 \times 8
					5600	8 \times 11.5
680	680	0.10	9	5600	8 \times 8	
				6100	8 \times 11.5	
820	820	0.10	9	5600	10 \times 12.5	
				6100	8 \times 11.5	
1000	1000	0.10	9	5600	10 \times 12.5	
				6100	8 \times 11.5	
1200	1200	0.10	9	6100	10 \times 12.5	
				6100	10 \times 12.5	
1500	1500	0.10	9	6100	10 \times 12.5	
				6100	10 \times 12.5	
16	180	576	0.08	9	5600	8 \times 11.5
					5600	8 \times 11.5
	220	704	0.08	9	5600	8 \times 11.5
					5600	8 \times 11.5
	270	864	0.08	9	5600	8 \times 11.5
					5600	8 \times 11.5
	330	528	0.08	9	5600	8 \times 11.5
					6100	10 \times 12.5
	390	624	0.08	9	5600	8 \times 11.5
					6100	10 \times 12.5
	470	752	0.10	9	5600	8 \times 11.5
					6100	10 \times 12.5
	560	896	0.10	9	5600	8 \times 11.5
					6100	10 \times 12.5
680	1000	0.10	9	6100	10 \times 12.5	
				6100	10 \times 12.5	
820	1280	0.10	9	6100	10 \times 12.5	
				6100	10 \times 12.5	
1000	1600	0.10	9	6100	10 \times 12.5	
				6100	10 \times 12.5	

Φ D \times L(mm)

Size List

WV(SV) Cap(μ F)	2.5 (2.8)	4 (4.6)	6.3 (7.2)	10 (11.5)	16 (18.4)
180			8 \times 8/8 \times 11.5	8 \times 8/8 \times 11.5	8 \times 11.5
220			8 \times 8/8 \times 11.5	8 \times 8/8 \times 11.5	8 \times 11.5
270			8 \times 8/8 \times 11.5	8 \times 8/8 \times 11.5	8 \times 11.5
330			8 \times 8/8 \times 11.5	8 \times 8/8 \times 11.5	8 \times 11.5/10 \times 12.5
390			8 \times 8/8 \times 11.5	8 \times 8/8 \times 11.5	8 \times 11.5/10 \times 12.5
470			8 \times 8/8 \times 11.5	8 \times 8/8 \times 11.5	8 \times 11.5/10 \times 12.5
560	8 \times 8/8 \times 11.5	8 \times 8/8 \times 11.5	8 \times 8/8 \times 11.5	8 \times 8/8 \times 11.5	8 \times 11.5/10 \times 12.5
680	8 \times 8/8 \times 11.5	8 \times 8/8 \times 11.5	8 \times 8/8 \times 11.5	8 \times 8/8 \times 11.5/10 \times 12.5	10 \times 12.5
820	8 \times 8/8 \times 11.5	8 \times 8/8 \times 11.5/10 \times 12.5	8 \times 8/8 \times 11.5	8 \times 11.5/10 \times 12.5	10 \times 12.5
1000	8 \times 8/8 \times 11.5	8 \times 8/8 \times 11.5	8 \times 8/8 \times 11.5/10 \times 12.5	8 \times 11.5/10 \times 12.5	10 \times 12.5
1200	8 \times 8/8 \times 11.5	8 \times 11.5/10 \times 12.5	8 \times 11.5/10 \times 12.5	10 \times 12.5	
1500	8 \times 8/8 \times 11.5	8 \times 11.5/10 \times 12.5	8 \times 11.5/10 \times 12.5	10 \times 12.5	
2000	8 \times 11.5/10 \times 12.5	10 \times 12.5	10 \times 12.5		
2500	10 \times 12.5	10 \times 12.5	10 \times 12.5		
2700	10 \times 12.5				
3000	10 \times 12.5				
3300	10 \times 12.5				
3500	10 \times 12.5				

Ripple Current (mA, rms) at 105°C 100KHz

PS series Standard Products

Features

- ◆ Low ESR at high frequency range.
- ◆ Large permissible ripple current.



Specifications

Item	Performance Characteristics	
Operating Temperature Range	-55~+105°C	
Rated Voltage Range	2.5~25 VDC	
Capacitance Range	39 to 3500 μF	
Capacitance Tolerance	±20%(120Hz,+20°C)	
Leakage Current (+20°C,max.)	≦0.2CV (μA, after 2 minutes)	
Dissipation Factor (tan δ , at 20°C , 120Hz)	Not to exceed the value specified	
ESR (100K~300KHz)	Not to exceed the value specified	
Endurance 105°C , 2000h , at rated voltage	Capacitance Change	Within ±20% of the value before test
	Leakage current	Not to exceed the value specified
	ESR	Not to exceed 150% of the value specified
	Dissipation Factor	Not to exceed 150% of the value specified
Moisture Resistance Stored at 60°C , RH90~95% , 1000h	Capacitance Change	Within ±20% of the value before test
	Leakage current	Not to exceed the value specified
	ESR	Not to exceed 150% of the value specified
	Dissipation Factor	Not to exceed 150% of the value specified

Conductive Polymer

Frequency Coefficient for Ripple Current

Frequency	120Hz ≤ freq. < 1KHz	1KHz ≤ freq. < 10KHz	10KHz ≤ freq. < 100KHz	100KHz ≤ freq. < 300KHz
Coefficient	0.05	0.3	0.7	1

Diagram of Dimensions:(unit:mm)

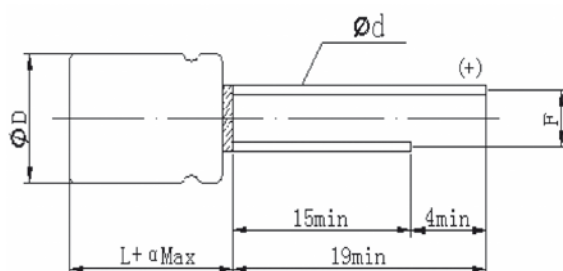

φD×L	φD+0.5max.	α	F±0.5	φd±0.05
8×8	8.0	1.0	3.5	0.6
8×11.5	8.0	1.5	3.5	0.6
10×12.5	10.0	1.5	5.0	0.6

Dimensions & Characteristics

φ D×L(mm)

W.V. (V)	Capacitance (μF)	L.C. (μA, 2min)	tg δ (120Hz, 20°C)	ESR (mΩ, 100KHz)	Maximum Permissible Ripple Current(mA, r.m.s)	Size φ D×L(mm)	
2.5	560	280	0.08	12	5100	8×8 8×11.5	
	680	340	0.08	12	5200	8×8 8×11.5	
	820	410	0.08	12	5200	8×8 8×11.5	
	1000	500	0.08	12	5500	8×8 8×11.5	
	1200	600	0.08	12	5500	8×8 8×11.5	
	1500	750	0.08	12	5500	8×8 8×11.5	
	2000	1000	0.08	12	5900	8×11.5 10×12.5	
	2200	1100	0.08	12	5900	10×12.5	
	2500	1250	0.08	12	5900	10×12.5	
	2700	1350	0.08	12	5900	10×12.5	
	3000	1500	0.08	12	5900	10×12.5	
	3300	1650	0.08	12	5900	10×12.5	
	3500	1750	0.10	12	5900	10×12.5	
4	560	448	0.08	12	5100 5200	8×8 8×11.5	
	680	544	0.08	12	5100 5200	8×8 8×11.5	
	820	656	0.08	12	5100 5200 5900	8×8 8×11.5 10×12.5	
	1000	800	0.10	12	5100 5500 5900	8×8 8×11.5 10×12.5	
	1200	960	0.10	12	5500 5900	8×11.5 10×12.5	
	1500	600	0.10	12	5500 5900	8×11.5 10×12.5	
	2000	800	0.10	12	5900	10×12.5	
	2200	880	0.10	12	5900	10×12.5	
	2500	1000	0.10	12	5900	10×12.5	
	6.3	180	226.8	0.07	21	5100	8×8 8×11.5
		220	277	0.07	21	5100	8×8 8×11.5
270		340.2	0.07	21	5100	8×8 8×11.5	
330		416	0.07	15	5100 5500	8×8 8×11.5	
390		491.4	0.08	15	5100 5500	8×8 8×11.5	
470		592	0.08	12	5100 5500	8×8 8×11.5	
560		705.6	0.08	12	5100 5500	8×8 8×11.5	
680		428	0.08	10	5100	8×8	
				12	5500 5900	8×11.5 10×12.5	
820		516.6	0.10	12	5100	8×8	
					5500 5900	8×11.5 10×12.5	
1000		630	0.10	12	5100	8×8	
					5500 5900	8×11.5 10×12.5	
1200		756	0.10	12	5500	8×11.5	
					5900	10×12.5	
1500		945	0.10	12	5500	8×11.5	
					5900	10×12.5	
2000	1260	0.10	12	5900	10×12.5		
2200	1386	0.10	12	5900	10×12.5		
2500	1575	0.10	12	5900	10×12.5		

Ripple Current (mA, rms) at 105°C, 100KHz

Dimensions & Characteristics

φ DxL(mm)

W.V. (V)	Capacitance (μF)	L.C. (μA,2min)	tg δ (120Hz,20°C)	ESR (mΩ,100KHZ)	Maximum Permissible Ripple Current(mA,r.m.s)	Size φD×L(mm)
10	180	180	0.08	15	5500	8×8
					5100	8×11.5
	220	220	0.08	15	5500	8×8
					5100	8×11.5
	270	270	0.08	15	5900	8×8
					5500	8×11.5
	330	330	0.08	12	5500	8×8
					5500	8×11.5
	390	390	0.08	12	5500	8×8
					5500	8×11.5
	470	470	0.08	12	5500	8×8
					5500	8×11.5
	560	560	0.08	12	5500	8×8
					5500	8×11.5
680	680	0.10	12	5100	8×8	
				5900	8×11.5	
820	820	0.10	12	5900	10×12.5	
				5900	8×11.5	
1000	1000	0.10	12	5900	10×12.5	
				5900	10×12.5	
1200	1200	0.10	12	5900	10×12.5	
				5900	10×12.5	
1500	1500	0.10	12	5900	10×12.5	
				5900	10×12.5	
16	100	160	0.08	12	4800	8×11.5
	150	240	0.08	12	4500	8×8
					4500	8×8
	180	288	0.08	15	4800	8×11.5
					4500	8×8
	220	352	0.08	15	4500	8×8
					5000	8×11.5
	270	432	0.08	12	4500	8×8
				15	5000	8×11.5
	330	528	0.08	12	5500	10×12.5
					4500	8×8
	390	624	0.08	12	5000	8×11.5
					5500	10×12.5
	470	752	0.10	12	5000	8×11.5
					5500	10×12.5
	560	896	0.10	12	5000	8×11.5
5500					10×12.5	
680	1000	0.10	12	5500	10×12.5	
				5500	10×12.5	
820	1000	0.10	12	5500	10×12.5	
				5500	10×12.5	
1000	1000	0.10	12	5500	10×12.5	

Ripple Current (mA, rms) at 105°C, 100KHz

φ D×L(mm)

W.V. (V)	Capacitance (μF)	L.C. (μA,2min)	tg δ (120Hz,20°C)	ESR (mΩ,100KHz)	Maximum Permissible Ripple Current(mA,r.m.s)	Size φ D×L(mm)
20	39	156	0.08	30	4500	8×8
					4100	8×11.5
	47	188	0.08	30	4500	8×8
					4100	8×11.5
	68	272	0.08	25	4500	8×8
					4100	8×11.5
	82	328	0.08	20	4500	8×8
					4100	8×11.5
	100	400	0.08	18	4500	8×8
					4100	8×11.5
					4900	10×12.5
	150	600	0.08	18	4500	8×8
					4100	8×11.5
					4900	10×12.5
180	720	0.08	18	4500	8×8	
				4100	8×11.5	
				4900	10×12.5	
220	880	0.08	18	4500	8×8	
				4100	8×11.5	
				4900	10×12.5	
270	1080	0.08	20	4100	8×11.5	
				4900	10×12.5	
				4100	8×11.5	
330	1320	0.08	20	4900	10×12.5	
				4900	10×12.5	
				4900	10×12.5	
390	1560	0.08	20	4900	10×12.5	
				4900	10×12.5	
				4900	10×12.5	
470	1880	0.08	20	4900	10×12.5	
				4900	10×12.5	
				4900	10×12.5	
25	39	195	0.08	25	4500	8×8
					4100	8×11.5
	47	235	0.08	20	4500	8×8
					4100	8×11.5
	68	340	0.08	20	4500	8×8
					4100	8×11.5
	82	410	0.08	20	4500	8×8
					4100	8×11.5
	100	500	0.08	15	4500	8×8
				20	4100	8×11.5
				4900	10×12.5	
	150	750	0.08	25	3500	8×8
				20	4100	8×11.5
				20	4900	10×12.5
180	900	0.08	25	3500	8×8	
			25	3800	8×11.5	
			20	4900	10×12.5	
220	1100	0.08	25	3500	8×8	
			25	3800	8×11.5	
			20	4900	10×12.5	
270	1350	0.08	25	3800	8×11.5	
			20	4900	10×12.5	
			25	3800	8×11.5	
330	1650	0.08	20	4900	10×12.5	
			20	4900	10×12.5	
			20	4900	10×12.5	
390	1950	0.08	25	4100	10×12.5	
				4100	10×12.5	
				4100	10×12.5	
470	2350	0.08	25	4100	10×12.5	
				4100	10×12.5	

Ripple Current (mA, rms) at 105°C, 100KHz

Size List

φ DxL(mm)

RV (SV) Cap(μF)	2.5 (2.8)	4 (4.6)	6.3 (7.2)	10 (11.5)	16 (18.4)	20 (23)	25 (27.5)
39						8×8/8×11.5	8×8/8×11.5
47						8×8/8×11.5	8×8/8×11.5
68						8×8/8×11.5	8×8/8×11.5
82						8×8/8×11.5	8×8/8×11.5
100					8×8	8×8/8×11.5 10×12.5	8×8/8×11.5 10×12.5
150					8×8	8×8/8×11.5 10×12.5	8×8/8×11.5 10×12.5
180			8×8/8×11.5	8×8/8×11.5	8×8/8×11.5	8×8/8×11.5 10×12.5	8×8/8×11.5 10×12.5
220			8×8/8×11.5	8×8/8×11.5	8×8/8×11.5	8×8/8×11.5 10×12.5	8×8/8×11.5 10×12.5
270			8×8/8×11.5	8×8/8×11.5	8×8/8×11.5 10×12.5	8×11.5/ 10×12.5	8×11.5/ 10×12.5
330			8×8/8×11.5	8×8/8×11.5	8×8/8×11.5 10×12.5	8×11.5/ 10×12.5	8×11.5/ 10×12.5
390			8×8/8×11.5	8×8/8×11.5	8×8/8×11.5 10×12.5	10×12.5	10×12.5
470			8×8/8×11.5	8×8/8×11.5	8×11.5/10×12.5	10×12.5	10×12.5
560	8×8/8×11.5	8×8/8×11.5	8×8/8×11.5	8×8/8×11.5	10×12.5		
680	8×8/8×11.5	8×8/8×11.5	8×8/8×11.5 10×12.5	8×11.5/10×12.5	10×12.5		
820	8×8/8×11.5	8×8/8×11.5 10×12.5	8×8/8×11.5 10×12.5	8×11.5/10×12.5	10×12.5		
1000	8×8/8×11.5	8×8/8×11.5 10×12.5	8×8/8×11.5 10×12.5	8×11.5/10×12.5	10×12.5		
1200	8×8/8×11.5	8×11.5/10×12.5	8×11.5/10×12.5	10×12.5			
1500	8×8/8×11.5	10×12.5	8×11.5/10×12.5	10×12.5			
2000	8×11.5/10×12.5	8×11.5/10×12.5	10×12.5				
2200	10×12.5	10×12.5	10×12.5				
2500	10×12.5	10×12.5	10×12.5				
2700	10×12.5						
3000	10×12.5						
3300	10×12.5						
3500	10×12.5						

Ripple Current (mA, rms) at 105°C 100KHz

PU series Ultra Low ESR $\leq 7m\Omega$

Features

- ◆ Ultra Low ESR at high frequency range.
- ◆ Ultra Large permissible ripple current.



Specifications

Item	Performance Characteristics	
Operating Temperature Range	-55~+105°C	
Rated Voltage Range	2.5~10 VDC	
Capacitance Range	180 to 3500 μ F	
Capacitance Tolerance	$\pm 20\%$ (120Hz,+20°C)	
Leakage Current (+20°C,max.)	$\leq 0.2CV$ (μ A, after 2 minutes)	
Dissipation Factor (tan δ , at 20°C , 120Hz)	Not to exceed the value specified	
ESR (100K~300KHz)	Not to exceed the value specified	
Endurance 105°C , 2000h , at rated voltage	Capacitance Change	Within $\pm 20\%$ of the value before test
	Leakage current	Not to exceed the value specified
	ESR	Not to exceed 150% of the value specified
	Dissipation Factor	Not to exceed 150% of the value specified
Moisture Resistance Stored at 60°C , RH90~95% , 1000h	Capacitance Change	Within $\pm 20\%$ of the value before test
	Leakage current	Not to exceed the value specified
	ESR	Not to exceed 150% of the value specified
	Dissipation Factor	Not to exceed 150% of the value specified

Frequency Coefficient for Ripple Current

Frequency	120Hz \leq freq.<1KHz	1KHz \leq freq.<10KHz	10KHz \leq freq.<100KHz	100KHz \leq freq.<300KHz
Coefficient	0.05	0.3	0.7	1

Diagram of Dimensions:(unit:mm)

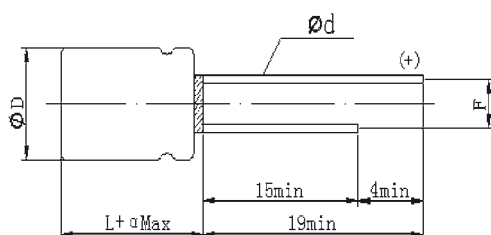

$\phi D \times L$	$\phi D+0.5\text{max.}$	α	$F \pm 0.5$	$\phi d \pm 0.05$
8×8	8.0	1.0	3.5	0.6
8×11.5	8.0	1.5	3.5	0.6
10×12.5	10.0	1.5	5.0	0.6

Dimensions & Characteristics

φ DxL(mm)

W.V. (V)	Capacitance (μF)	L.C. (μA,2min)	tg δ (120Hz,20°C)	ESR (mΩ,100KHZ)	Maximum Permissible Ripple Current(mA,r.m.s)	Size ΦD×L(mm)
2.5	560	280	0.08	7	6100	8×8 8×11.5
	680	340	0.08	7	6100	8×8 8×11.5
	820	410	0.08	7	6100	8×8 8×11.5
	1000	500	0.08	7	6100	8×11.5
	1200	600	0.08	7	6100	8×11.5
	1500	750	0.08	7	6100	8×11.5
					7100	10×12.5
	2000	1000	0.08	7	6100	8×11.5
				7	7100	10×12.5
	2500	1250	0.08	7	7100	10×12.5
	2700	1350	0.08	7	7100	10×12.5
	3000	1500	0.08	7	7100	10×12.5
	3300	1650	0.08	7	7100	10×12.5
3500	1750	0.08	7	7100	10×12.5	
4	560	224	0.08	7	6100	8×8 8×11.5
	680	272	0.08	7	6100	8×8 8×11.5
	820	328	0.08	7	6100	8×8 8×11.5
					6600	10×12.5
	1000	800	0.08	7	6100	8×8
					6100	8×11.5
					6600	10×12.5
	1200	960	0.08	7	6100	8×11.5
					6600	10×12.5
	1500	1200	0.10	7	6100	8×11.5
2000	1600	0.10	7	6600	10×12.5	
2500	1500	0.10	7	6600	10×12.5	
6.3	180	113.4	0.10	7	6100	8×8 8×11.5
	220	138.6	0.10	7	6100	8×8 8×11.5
	270	170	0.10	7	6100	8×8 8×11.5
	330	207.9	0.10	7	6100	8×8 8×11.5
	390	245.7	0.10	7	6100	8×8 8×11.5
	470	296.1	0.10	7	6100	8×8 8×11.5
	560	352	0.08	7	6100	8×8 8×11.5
	680	428.4	0.08	7	6100	8×8
					6600	8×11.5/10×12.5
	820	516.6	0.10	7	6100	8×8
					6600	8×11.5/10×12.5
	1000	630	0.10	7	7100	8×11.5/10×12.5
	1200	756	0.10	7	7100	8×11.5/10×12.5
	1500	945	0.10	7	7100	10×12.5
	2000	1260	0.10	7	7100	10×12.5
2500	1575	0.10	7	7100	10×12.5	
10	180	180	0.08	7	6600	8×11.5
	220	220	0.08	7	6600	8×11.5
	270	270	0.08	7	6600	8×11.5
	330	330	0.08	7	6600	8×11.5
	390	390	0.08	7	6600	8×11.5
	470	470	0.08	7	6600	8×11.5
	560	560	0.08	7	6600	8×11.5/10×12.5
	680	680	0.10	7	6600	8×11.5/10×12.5
	820	820	0.10	7	7100	8×11.5/10×12.5
	1000	1000	0.10	7	7100	10×12.5
	1200	1200	0.10	7	7100	10×12.5
	1500	1500	0.10	7	7100	10×12.5

Ripple Current (mA, rms) at 105°C, 100KHz

Size List

φ DxL(mm)

WV (SV) Cap(μF)	2.5 (2.8)	4 (4.6)	6.3 (7.2)	10 (11.5)
180			8×8/8×11.5	8×11.5
220			8×8/8×11.5	8×11.5
270			8×8/8×11.5	8×11.5
330			8×8/8×11.5	8×11.5
390			8×8/8×11.5	8×11.5
470			8×8/8×11.5	8×11.5/10×12.5
560	8×8/8×11.5	8×8/8×11.5	8×8/8×11.5	8×11.5/10×12.5
680	8×8/8×11.5	8×8/8×11.5	8×8/8×11.5/10×12.5	8×11.5/10×12.5
820	8×8/8×11.5	8×8/8×11.5/10×12.5	8×8/8×11.5/10×12.5	8×11.5/10×12.5
1000	8×11.5	8×8/8×11.5/10×12.5	8×11.5/10×12.5	10×12.5
1200	8×11.5	8×11.5/10×12.5	8×11.5/10×12.5	10×12.5
1500	8×11.5/10×12.5	8×11.5/10×12.5	8×11.5/10×12.5	
2000	8×11.5/10×12.5	10×12.5	10×12.5	
2500	10×12.5	10×12.5	10×12.5	
2700	10×12.5			
3000	10×12.5			
3300	10×12.5			
3500	10×12.5			

Ripple Current (mA, rms) at 105°C 100KHz

PX series Low Profile

Features

- ◆ Low profile
- ◆ Low ESR at high frequency range &.Large permissible ripple current.



Specifications

Item	Performance Characteristics	
Operating Temperature Range	-55~+105°C	
Rated Voltage Range	2.5~25 VDC	
Capacitance Range	320 to 820 μ F	
Capacitance Tolerance	$\pm 20\%$ (120Hz,+20°C)	
Leakage Current (+20°C,max.)	Not to exceed the value specified (μ A, after 2 minutes)	
Dissipation Factor (tan δ , at 20°C , 120Hz)	Not to exceed the value specified	
ESR (100K~300KHz)	Not to exceed the value specified	
Endurance 105°C , 2000h , at rated voltage	Capacitance Change	Within $\pm 20\%$ of the value before test
	Leakage current	Not to exceed the value specified
	ESR	Not to exceed 150% of the value specified
	Dissipation Factor	Not to exceed 150% of the value specified
Moisture Resistance Stored at 60°C , RH90~95% , 1000h	Capacitance Change	Within $\pm 20\%$ of the value before test
	Leakage current	Not to exceed the value specified
	ESR	Not to exceed 150% of the value specified
	Dissipation Factor	Not to exceed 150% of the value specified

Conductive Polymer

Frequency Coefficient for Ripple Current

Frequency	120Hz \leq freq.<1KHz	1KHz \leq freq.<10KHz	10KHz \leq freq.<100KHz	100KHz \leq freq.<300KHz
Coefficient	0.05	0.3	0.7	1

Diagram of Dimensions:(unit:mm)

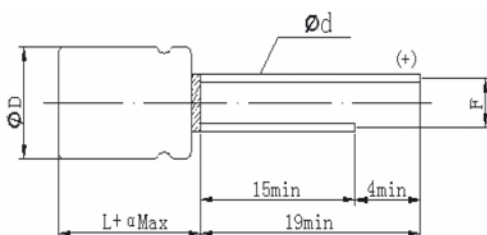

$\phi D \times L$	$\phi D+0.5\text{max.}$	α	$F \pm 0.5$	$\phi d \pm 0.05$
4×5 / 4×7	4	1.0	1.5	0.45
4×10	4.0	1.0	1.5	0.50
5×5 / 5×7	5	1.0	2.0	0.45
5×8 / 5×9	5	1.0	2.0	0.5
5×11	5	1.0	2.0	0.6
6.3×5.2 / 6.3×7	6.3	1.0	2.5	0.45
6.3×9	6.3	1.0	2.5	0.5
6.3×11	6.3	1.0	2.5	0.6

Dimensions & Characteristics

φ DxL(mm)

W.V. (V)	Capacitance (μF)	L.C. (μA,2min)	tg δ (120Hz,20°C)	ESR (mΩ,100KHZ)	Maximum Permissible Ripple Current(mA,r.m.s)	Size φ D×L(mm)
2.5	100	300	0.08	30	1670	4×5
				30	1970	5×5
	150	300	0.08	30	1970	5×5
				30	2200	6.3×5.2
	180	300	0.08	30	1970	5×5
				30	2200	6.3×5.2
	220	300	0.08	30	2200	5×5
				30	2610	6.3×5.2
	270	300	0.08	25	2610	6.3×5.2
				20	2690	6.3×7
	330	300	0.08	25	2610	6.3×5.2
				20	2690	6.3×7
	390	300	0.08	20	2690	6.3×5.2/6.3×7
	470	300	0.08	15	3100	6.3×5.2/6.3×7
560	300	0.08	15	3100	5×9	
680	300	0.08	15	3500	6.3×7	
100	300	0.08	30	1970	5×5	
4	150	300	0.08	30	2200	6.3×5.2
				25	2670	6.3×7
	180	300	0.08	30	2200	6.3×5.2
				25	2670	6.3×7
	220	300	0.08	25	2610	6.3×5.2
				20	2690	6.3×7
	270	300	0.08	25	2610	6.3×5.2
				20	2690	6.3×7
	330	300	0.08	20	2690	6.3×5.2
				15	3100	6.3×7
	390	300	0.08	20	2690	6.3×5.2
	470	300	0.08	15	3100	6.3×7
	560	300	0.08	15	3500	6.3×7
	6.3 / 6.8	100	300	0.08	35	1900
25					2100	5×7
25					2390	6.3×5.2
20					2690	6.3×7
150		300	0.08	35	1900	4×7
				25	2100	5×7
				25	2390	6.3×5.2
				20	2690	6.3×7
180		300	0.08	30	1970	5×5
				25	2300	5×7
				20	2690	6.3×5.2
				20	2690	6.3×7
220		300	0.08	20	2450	5×7
				15	2690	5×8
				20	2690	6.3×5.2
				15	3100	6.3×7
270		300	0.08	30	2000	4×10
				20	2450	5×7
				15	2690	5×8
				20	2690	6.3×5.2
300		300	0.08	30	2000	4×10
				20	2690	6.3×5.2
				15	2690	5×8
				15	3100	5×9
330		300	0.08	15	3100	6.3×7
				15	3100	5×9
				15	3100	5×9
				15	3100	6.3×7
390	300	0.08	15	3100	6.3×7	
			15	3100	6.3×9	
			15	3500	6.3×11	
			15	3100	6.3×7	
450	300	0.08	15	3100	6.3×9	
			15	3500	6.3×11	
			15	3100	6.3×7	
			15	3100	6.3×9	
470	300	0.08	15	3100	6.3×9	
			15	3500	6.3×11	
			15	3100	6.3×7	
			15	3100	6.3×9	
680	300	0.08	15	3100	6.3×9	
			15	3500	6.3×11	
			15	3100	6.3×9	
			15	3500	6.3×11	
7.5	270	300	0.08	15	2690	5×8
	330	300	0.08	15	3100	5×9
	390	300	0.08	15	3100	5×9
	470	300	0.08	15	3100	5×9
	500	300	0.08	15	3100	5×9
	680	300	0.08	15	3100	6.3×9
	680	300	0.08	15	3500	6.3×11

Ripple Current (mA, rms) at 105°C, 100KHz

W.V. (V)	Capacitance (μ F)	L.C. (μ A,2min)	tg δ (120Hz,20°C)	ESR (m Ω ,100KHZ)	Maximum Permissible Ripple Current(mA,r.m.s)	Size Φ D×L(mm)
10	10	300	0.08	45	1200	4×5
	15	300	0.08	45	1200	4×5
	22	300	0.08	45	1200	4×5
	33	300	0.08	45	1670	5×5
				30	2200	6.3×5.2
	39	300	0.08	45	1670	5×5
				30	2200	6.3×5.2
	47	300	0.08	30	2200	6.3×5.2
				20	2690	6.3×7
	68	300	0.08	30	2200	6.3×5.2
				20	2690	6.3×7
	82	300	0.08	30	2200	6.3×5.2
				20	2690	6.3×7
	100	300	0.08	30	2200	6.3×5.2
				20	2690	6.3×7
	150	300	0.08	25	2200	6.3×5.2
				20	2690	6.3×7
	180	300	0.08	20	2690	5×11
				20	2690	6.3×7
				20	2690	6.3×9
20				2690	5×11	
220	300	0.08	20	2690	6.3×7	
			20	2690	6.3×9	
			20	2690	6.3×9	
			20	2690	5×11	
270	300	0.08	20	3100	6.3×7	
			20	3100	6.3×9	
			15	3500	6.3×11	
			15	3100	6.3×9	
330	300	0.08	15	3100	6.3×9	
			15	3500	6.3×11	
390	300	0.08	15	3100	6.3×9	
			15	3500	6.3×11	
470	300	0.08	15	3100	6.3×9	
			15	3500	6.3×11	
16	10	300	0.08	30	2200	6.3×5.2
				25	2610	6.3×7
	15	300	0.08	30	2200	6.3×5.2
				25	2610	6.3×7
	22	300	0.08	30	2200	6.3×5.2
				25	2610	6.3×7
	33	300	0.08	30	2200	6.3×5.2
				25	2610	6.3×7
	47	300	0.08	30	2200	6.3×5.2
				25	2610	6.3×7
	68	300	0.08	30	2200	6.3×5.2
				20	2690	6.3×7
	82	300	0.08	20	2690	6.3×7
				30	2200	6.3×5.2
	100	300	0.08	20	2690	5×11
				20	2690	6.3×7
15				3500	6.3×11	
20				2690	6.3×7	
150	300	0.08	20	2690	6.3×7	
			15	3500	6.3×11	
180	300	0.08	20	3100	6.3×9	
			15	3500	6.3×11	
220	300	0.08	20	3100	6.3×9	
			15	3500	6.3×11	
270	300	0.08	15	3500	6.3×11	
20	10	300	0.08	30	2200	6.3×5.2
				25	2670	6.3×7
	15	300	0.08	30	2200	6.3×5.2
				25	2670	6.3×7
	22	300	0.08	30	2200	6.3×5.2
				25	2670	6.3×7
	33	300	0.08	25	2670	6.3×7
				25	2670	6.3×9
	39	300	0.08	25	2670	6.3×7
				25	2670	6.3×9
47	300	0.08	25	2670	6.3×7	
			25	2670	6.3×9	
68	300	0.08	25	2670	6.3×9	
			20	2900	6.3×11	
82	300	0.08	20	2900	6.3×11	

Conductive Polymer

W.V. (V)	Capacitance (μ F)	L.C. (μ A,2min)	tg δ (120Hz,20°C)	ESR (m Ω ,100KHZ)	Maximum Permissible Ripple Current(mA,r.m.s)	Size ϕ D \times L(mm)
25	10	300	0.08	30	2200	6.3 \times 5.2
				25	2670	6.3 \times 7
	15	300	0.08	25	2200	6.3 \times 5.2
					2670	6.3 \times 7
	22	300	0.08	25	2670	6.3 \times 7
					2670	6.3 \times 9
	33	300	0.08	25	2670	6.3 \times 7
					2670	6.3 \times 9
	39	300	0.08	25	2670	6.3 \times 7
					2670	6.3 \times 9
	47	300	0.08	25	2670	6.3 \times 9
					2900	6.3 \times 9
	68	300	0.08	20	2900	6.3 \times 11
					2900	6.3 \times 11

Ripple Current (mA, rms) at 105°C, 100KHz

Size List

ϕ D \times L(mm)

WV (SV) Cap(μ F)	2.5(2.8)	4(4.6)	6.3/6.8(7.2)	7.5(8.7)	10(11.5)	16(18.4)	20(23)	25(27.5)
10					4 \times 5	6.3 \times 5.2/6.3 \times 7	6.3 \times 5.2/6.3 \times 7	6.3 \times 5.2/6.3 \times 7
15					4 \times 5	6.3 \times 5.2/6.3 \times 7	6.3 \times 5.2/6.3 \times 7	6.3 \times 5.2/6.3 \times 7
22					4 \times 5	6.3 \times 5.2/6.3 \times 7	6.3 \times 5.2/6.3 \times 7	6.3 \times 7/6.3 \times 9
33					5 \times 5/6.3 \times 5.2	6.3 \times 5.2/6.3 \times 7	6.3 \times 7/6.3 \times 9	6.3 \times 7/6.3 \times 9
39					5 \times 5/6.3 \times 5.2	6.3 \times 5.2/6.3 \times 7	6.3 \times 7/6.3 \times 9	6.3 \times 7/6.3 \times 9
47					6.3 \times 5.2/6.3 \times 7	6.3 \times 5.2/6.3 \times 7	6.3 \times 7/6.3 \times 9	6.3 \times 9/6.3 \times 11
68					6.3 \times 5.2/6.3 \times 7	6.3 \times 5.2/6.3 \times 7	6.3 \times 9/6.3 \times 11	6.3 \times 11
82					6.3 \times 5.2/6.3 \times 7	6.3 \times 7	6.3 \times 11	
100	4 \times 5/5 \times 5	5 \times 5	4 \times 7/5 \times 7 6.3 \times 5.2/6.3 \times 7		6.3 \times 5.2/6.3 \times 7	5 \times 11/6.3 \times 5.2 6.3 \times 7/6.3 \times 11		
150	5 \times 5/6.3 \times 5.2	6.3 \times 5.2/6.3 \times 7	4 \times 7/5 \times 7 6.3 \times 5.2/6.3 \times 7		6.3 \times 5.2/6.3 \times 7	6.3 \times 7/6.3 \times 11		
180	5 \times 5/6.3 \times 5.2	6.3 \times 5.2/6.3 \times 7	5 \times 5/5 \times 7 6.3 \times 5.2/6.3 \times 7		5 \times 11/6.3 \times 7 6.3 \times 9	6.3 \times 7/6.3 \times 11		
220	5 \times 5/6.3 \times 5.2	6.3 \times 5.2/6.3 \times 7	5 \times 7/5 \times 8 6.3 \times 5.2/6.3 \times 7		5 \times 11/6.3 \times 7 6.3 \times 9	6.3 \times 9/6.3 \times 11		
270	6.3 \times 5.2/6.3 \times 7	6.3 \times 5.2/6.3 \times 7	4 \times 10/5 \times 7 5 \times 8/6.3 \times 5.2 6.3 \times 7		5 \times 11/6.3 \times 7 6.3 \times 9/6.3 \times 11	6.3 \times 11		
330	6.3 \times 5.2/6.3 \times 7	6.3 \times 5.2/6.3 \times 7	5 \times 8/5 \times 9 6.3 \times 5.2/6.3 \times 7	5 \times 9	6.3 \times 9/6.3 \times 11			
390	6.3 \times 5.2/6.3 \times 7	6.3 \times 5.2/6.3 \times 7	5 \times 9/6.3 \times 7 6.3 \times 9/6.3 \times 11	5 \times 9	6.3 \times 9/6.3 \times 11			
450			6.3 \times 7/6.3 \times 9 6.3 \times 11					
470	6.3 \times 5.2/6.3 \times 7	6.3 \times 7	6.3 \times 7/6.3 \times 9 6.3 \times 11	5 \times 9	6.3 \times 9/6.3 \times 11			
500				5 \times 9				
560	5 \times 9/6.3 \times 7	6.3 \times 11						
680	6.3 \times 11		6.3 \times 9/6.3 \times 11	6.3 \times 9				
820			6.3 \times 11					

Ripple Current (mA, rms) at 105°C 100KHz

PE series

Features

- ◆ Down Size to $\phi 6.3 \times 8$.
- ◆ Low ESR & large capacitance.
- ◆ Large permissible ripple current.



Specifications

Item	Performance Characteristics	
Operating Temperature Range	-55~+105°C	
Rated Voltage Range	2.5~6.3 VDC	
Capacitance Range	470 to 820 μ F	
Capacitance Tolerance	$\pm 20\%$ (120Hz, +20°C)	
Leakage Current (+20°C, max.)	$\leq 0.2CV$ (μ A, after 2 minutes)	
Dissipation Factor (tan δ · at 20°C · 120Hz)	Not to exceed the value specified	
ESR (100K~300KHz)	Not to exceed the value specified	
Endurance 105°C · 2000h · at rated voltage	Capacitance Change	Within $\pm 20\%$ of the value before test
	Leakage current	Not to exceed the value specified
	ESR	Not to exceed 150% of the value specified
	Dissipation Factor	Not to exceed 150% of the value specified
Moisture Resistance Stored at 60°C · RH90~95% · 1000h	Capacitance Change	Within $\pm 20\%$ of the value before test
	Leakage current	Not to exceed the value specified
	ESR	Not to exceed 150% of the value specified
	Dissipation Factor	Not to exceed 150% of the value specified

Conductive Polymer

Frequency Coefficient for Ripple Current

Frequency	120Hz \leq freq. < 1KHz	1KHz \leq freq. < 10KHz	10KHz \leq freq. < 100KHz	100KHz \leq freq. < 300KHz
Coefficient	0.05	0.3	0.7	1

Diagram of Dimensions:(unit:mm)

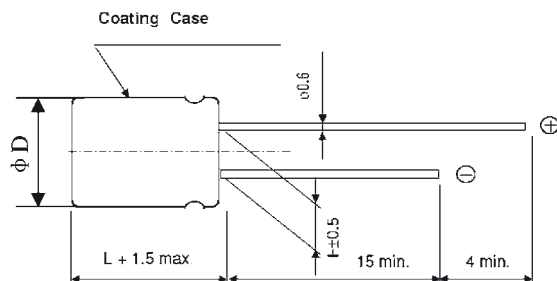

$\phi D \times L$	$\phi D + 0.5 \text{ max.}$	α	$F \pm 0.5$	$\phi d \pm 0.05$
6.3 \times 8	6.3	1.5	2.5	0.6

Dimensions & Characteristics

W.V. (V)	Capacitance (μ F)	L.C. (μ A, 2min)	tg δ (120Hz, 20°C)	ESR (m Ω , 100kHz)	Maximum Permissible Ripple Current(mA, r.m.s)	Size $\phi D \times L$ (mm)
2.5	820	410	0.08	8	5600	6.3 \times 8
4	560	448	0.08	8	5600	
6.3	470	592.2	0.08	9	5100	
	560	705.6	0.08	9	5100	
	620	781.2	0.08	9	4500	

Ripple Current (mA, rms) at 105°C, 100KHz

PW series

Features

- ◆ Low height
- ◆ Low ESR at high frequency range.



Specifications

Item	Performance Characteristics	
Operating Temp. Range	-55°C~+105°C	
Rated Voltage Range	2.5~25V DC	
Capacitance Range	39 to 2500 μF	
Capacitance Tolerance	±20% (120Hz , +20°C)	
Leakage Current (+20°C , max)	≤0.2CV (μA , after 2 minutes)	
Dissipation Factor (tan δ , at 20°C , 120Hz)	Not to exceed the value specified	
ESR (100K~300KHz)	Not to exceed the value specified	
Endurance 105°C , 2000h , at rated voltage	Capacitance Change	Within ±20% of the value before test
	Leakage current	Not to exceed the value specified
	ESR	Not to exceed 150% of the value specified
	Dissipation Factor	Not to exceed 150% of the value specified
Moisture Resistance Stored at 60°C , RH90~95% , 1000h	Capacitance Change	Within ±20% of the value before test
	Leakage Current	Not to exceed the value specified
	ESR	Not to exceed 150% of the value specified
	Dissipation Factor	Not to exceed 150% of the value specified

Frequency Coefficient for Ripple Current

Frequency	120Hz ≤ freq. < 1KHz	1KHz ≤ freq. < 10KHz	10KHz ≤ freq. < 100KHz	100KHz ≤ freq. < 300KHz
Coefficient	0.05	0.3	0.7	1

Diagram of Dimensions:(unit:mm)

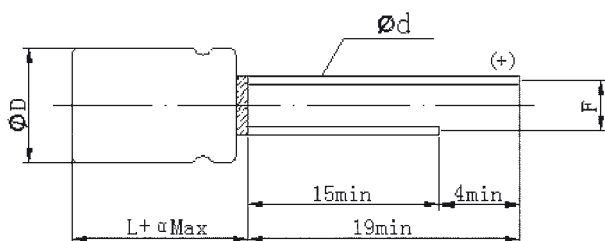

φD×L	φD+0.5max.	α	F±0.5	φd±0.05
8×7	8.0	1.0	3.5	0.6
10×7	10.0	1.5	5.0	0.6
10×10	10.0	1.5	5.0	0.6

Dimensions & Characteristics

φ D×L(mm)

W.V. (V)	Capacitance (μF)	L.C. (μA,2min)	tg δ (120Hz,20°C)	ESR (mΩ,100KHZ)	Maximum Permissible Ripple Current(mA,r.m.s)	Size φ D×L(mm)
2.5	820	410	0.08	20	3700	8×7
	1000	500	0.08	20	3700	8×7
	1200	600	0.08	15	4200	10×7
	1500	750	0.10	15	4200	10×7
	1800	900	0.10	15	4200	10×7
				12	4500	10×10
	2000	1000	0.10	15	4200	10×7
12				4500	10×10	
2500	1250	0.10	12	4500	10×10	
4	560	448	0.08	20	3700	8×7
	680	544	0.08	20	3700	8×7
	820	656	0.08	20	3700	8×7
				15	4200	10×7
	1000	800	0.10	15	4200	10×7
				12	4500	10×10
	1200	960	0.10	15	4200	10×7
				12	4500	10×10
1500	1200	0.10	15	4200	10×7	
			12	4500	10×10	
1800	1440	0.10	12	4500	10×10	
6.3	470	592	0.08	20	3700	8×7
	560	705.6	0.08	20	3700	8×7
	680	856.8	0.08	20	3700	8×7
	820	1033.2	0.10	20	3700	8×7
				15	4200	10×7
	1000	1260	0.10	15	4200	10×7
				12	4500	10×10
	1200	1512	0.10	15	4200	10×7
12				4500	10×10	
1500	1890	0.10	12	4500	10×10	
10	330	660	0.08	20	3700	8×7
	390	780	0.08	20	3700	8×7
	470	940	0.08	20	3700	8×7
				15	4200	10×7
	560	1120	0.08	15	4200	10×7
				12	4500	10×10
	680	1360	0.10	15	4200	10×7
				12	4500	10×10
820	1640	0.10	15	4200	10×7	
			12	4500	10×10	
1000	2000	0.10	12	4500	10×10	
16	180	576	0.08	20	3300	8×7
	220	704	0.08	20	3300	8×7
	270	864	0.08	20	3300	8×7
				20	3700	10×7
	330	1056	0.10	20	3700	10×7
				15	4200	10×10
	390	1248	0.10	20	3700	10×7
				20	4200	10×10
470	1504	0.10	20	3700	10×7	
			15	4200	10×10	
560	1792	0.10	15	4200	10×10	

Conductive Polymer

W.V. (V)	Capacitance (μ F)	L.C. (μ A,2min)	tg δ (120Hz,20°C)	ESR (m Ω ,100KHZ)	Maximum Permissible Ripple Current(mA,r.m.s)	Size Φ D \times L(mm)
20	56	224	0.08	25	3000	8 \times 7
	68	272	0.08	25	3000	8 \times 7
	82	328	0.08	25	3000	8 \times 7
				25	3400	10 \times 7
	100	400	0.08	25	3000	8 \times 7
				25	3400	10 \times 7
				20	3800	10 \times 10
	150	600	0.08	25	3000	8 \times 7
				25	3400	10 \times 7
				20	3800	10 \times 10
	180	720	0.08	25	3000	8 \times 7
				25	3400	10 \times 7
20				3800	10 \times 10	
220	880	0.10	25	3400	10 \times 7	
			20	3800	10 \times 10	
270	1080	0.10	25	3400	10 \times 7	
			20	3800	10 \times 10	
330	1320	0.10	20	3800	10 \times 10	
25	39	195	0.08	25	3000	8 \times 7
	47	235	0.08	25	3000	8 \times 7
	56	280	0.08	25	3000	8 \times 7
				25	3000	8 \times 7
	68	340	0.08	25	3000	8 \times 7
				25	3400	10 \times 7
	82	410	0.08	25	3000	8 \times 7
				25	3400	10 \times 7
				20	3800	10 \times 10
	100	500	0.10	25	3400	10 \times 7
				20	3800	10 \times 10
	120	600	0.10	25	3400	10 \times 7
20				3800	10 \times 10	
150	750	0.10	25	3400	10 \times 7	
			20	3800	10 \times 10	
180	900	0.10	20	3800	10 \times 10	

Ripple Current (mA, rms) at 105°C, 100KHz

Size List

Φ D \times L(mm)

WV (SV) Cap(μ F)	2.5(2.8)	4(4.6)	6.3(7.2)	10(11.5)	16(18.4)	20(23)	25(27.5)
39							8 \times 7
47							8 \times 7
56						8 \times 7	8 \times 7/10 \times 7
68						8 \times 7	8 \times 7/10 \times 7
82						8 \times 7/10 \times 7	8 \times 7/10 \times 7/10 \times 10
100						8 \times 7/10 \times 7/10 \times 10	10 \times 7/10 \times 10
150						8 \times 7/10 \times 7/10 \times 10	10 \times 7/10 \times 10
180					8 \times 7	8 \times 7/10 \times 7/10 \times 10	10 \times 10
220					8 \times 7	10 \times 7/10 \times 10	
270					8 \times 7/10 \times 7	10 \times 7/10 \times 10	
330				8 \times 7	10 \times 7/10 \times 10	10 \times 10	
390				8 \times 7	10 \times 7/10 \times 10		
470			8 \times 7	8 \times 7/10 \times 7	10 \times 7/10 \times 10		
560		8 \times 7	8 \times 7	10 \times 7/10 \times 10	10 \times 10		
680		8 \times 7	8 \times 7	10 \times 7/10 \times 10			
820	8 \times 7	8 \times 7/10 \times 7	8 \times 7/10 \times 7	10 \times 7/10 \times 10			
1000	8 \times 7	10 \times 7	10 \times 7/10 \times 10	10 \times 10			
1200	10 \times 7	10 \times 7/10 \times 10	10 \times 7/10 \times 10				
1500	10 \times 7	10 \times 7/10 \times 10	10 \times 10				
1800	10 \times 7/10 \times 10	10 \times 10					
2000	10 \times 7/10 \times 10						
2500	10 \times 10						

Ripple Current (mA, rms) at 105°C 100KHz

PH series High Voltage/High Reliability

Features

- ◆ High voltage and high reliability
- ◆ Large permissible ripple current.
- ◆ Low ESR at high frequency range.



Specifications

Item	Performance Characteristics	
Operating Temp. Range	-55°C ~ +105°C	
Capacitance Range	10 ~ 150 μF	
Capacitance Tolerance	M : ±20%	
Rated Voltage Range	35 ~ 50V DC	
Dissipation Factor (at 120Hz, 20°C)	Not to exceed the value specified	
Leakage Current	≤ 0.2CV (μA, after 2 minutes)	
ESR (100K~300KHz)	Not to exceed the value specified	
Endurance 105°C · 2000h · at rated voltage	Capacitance Change	Within ±20% of the value before test
	Leakage current	Not to exceed the value specified
	ESR	Not to exceed 150% of the value specified
	Dissipation Factor	Not to exceed 150% of the value specified
Moisture Resistance Stored at 60°C · RH90~95% · 1000h	Capacitance Change	Within ±20% of the value before test
	Leakage Current	Not to exceed the value specified
	ESR	Not to exceed 150% of the value specified
	Dissipation Factor	Not to exceed 150% of the value specified

Conductive Polymer

Frequency Coefficient for Ripple Current

Frequency	120Hz ≤ freq. < 1KHz	1KHz ≤ freq. < 10KHz	10KHz ≤ freq. < 100KHz	100KHz ≤ freq. < 300KHz
Coefficient	0.05	0.3	0.7	1

Diagram of Dimensions:(unit:mm)

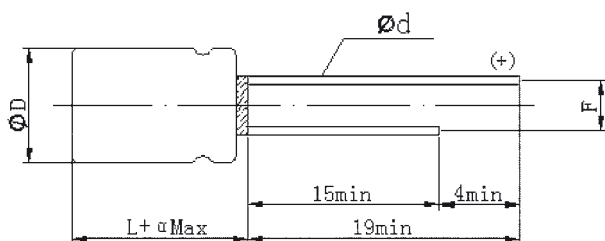

φD × L	φD + 0.5max.	α	F ± 0.5	φd ± 0.05
6.3 × 8	6.3	1.0	2.5	0.6
8 × 8	8.0	1.0	3.5	0.6
8 × 11.5	8.0	1.5	3.5	0.6
10 × 12.5	10.0	1.5	5.0	0.6

Dimensions & Characteristics

φ D×L(mm)

W.V. (V)	Capacitance (μF)	L.C. (μA,2min)	tg δ (120Hz,20°C)	ESR (mΩ,100KHZ)	Maximum Permissible Ripple Current(mA,r.m.s)	Size φ D×L(mm)
35	10	100	0.12	40	2100	6.3×8
				25	2890	8×11.5
	22	154	0.12	40	2100	6.3×8
				25	2890	8×11.5
	33	231	0.12	30	2500	8×8
				25	2890	8×11.5
	39	273	0.12	30	2500	8×8
				25	2890	8×11.5
	47	329	0.12	25	2890	8×11.5
					3500	10×12.5
	56	392	0.12	25	2890	8×11.5
					3500	10×12.5
68	476	0.12	25	2890	8×11.5	
			20	3700	10×12.5	
82	574	0.12	25	3700	10×12.5	
100	700	0.12	25	3700	10×12.5	
150	1050	0.12	25	3700	10×12.5	
50	10	100	0.12	45	1500	8×8
				40	1800	8×11.5
	22	220	0.12	40	1800	8×11.5
	33	330	0.12	35	2000	10×12.5
	39	390	0.12	35	2000	10×12.5
	47	470	0.12	35	2000	10×12.5
	56	560	0.12	35	2000	10×12.5
68	680	0.12	35	2000	10×12.5	

Ripple Current (mA, rms) at 105°C, 100KHz

PT series 125°C Guaranteed

Features

- ◆ 125°C Guaranteed.
- ◆ Low ESR at high frequency range.



Specifications

Item	Performance Characteristics	
Operating Temp. Range	-55°C ~ +125°C	
Capacitance Range	100 ~ 2700 μF	
Capacitance Tolerance	M : ±20%	
Rated Voltage Range	2.5V ~ 16V DC	
Dissipation Factor (at 120Hz, 20°C)	Not to exceed the value specified	
Leakage Current	≤ 0.2CV (μA, after 2 minutes)	
ESR (100K~300KHz)	Not to exceed the value specified	
Endurance 125°C · 2000h · at rated voltage	Capacitance Change	Within ±20% of the value before test
	Leakage current	Not to exceed the value specified
	ESR	Not to exceed 150% of the value specified
	Dissipation Factor	Not to exceed 150% of the value specified
Moisture Resistance Stored at 60°C · RH90~95% · 1000h	Capacitance Change	Within ±20% of the value before test
	Leakage Current	Not to exceed the value specified
	ESR	Not to exceed 150% of the value specified
	Dissipation Factor	Not to exceed 150% of the value specified

Conductive Polymer

Frequency Coefficient for Ripple Current

Frequency	120Hz ≤ freq. < 1KHz	1KHz ≤ freq. < 10KHz	10KHz ≤ freq. < 100KHz	100KHz ≤ freq. < 300KHz
Coefficient	0.05	0.3	0.7	1

Diagram of Dimensions:(unit:mm)

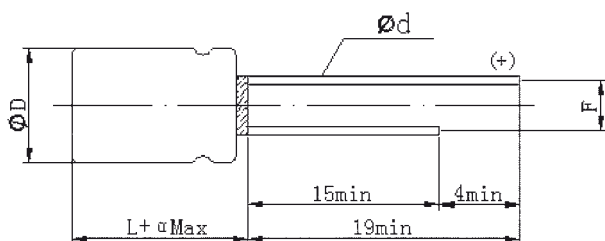

φ D × L	φ D + 0.5max.	α	F ± 0.5	φ d ± 0.05
6.3 × 11	6.3	1.5	2.5	0.6
8 × 8	8.0	1.0	3.5	0.6
8 × 11.5	8.0	1.5	3.5	0.6
10 × 12.5	10.0	1.5	5.0	0.6

Dimensions & Characteristics

φ D×L(mm)

W.V. (V)	Capacitance (μF)	L.C. (μA,2min)	tg δ (120Hz,20°C)	ESR (mΩ,100KHZ)	Rated Ripple Current	Allowable ripple current	Size φ D×L(mm)
					100KHz (mA,r.m.s)		
					105°C < T _x ≤125°C	T _x ≤105°C	
2.5	820	410	0.08	9	1929	6100	8×8 8×11.5
	1000	500	0.08	9	1929	6100	8×11.5
	1200	600	0.08	9	1929	6100	8×11.5
	1500	750	0.08	9	1929	6100	8×11.5
	2000	1000	0.08	9	2100	6640	10×12.5
	2500	1250	0.08	9	2100	6640	10×12.5
	2700	1350	0.08	9	2100	6640	10×12.5
4	560	224	0.08	9	1929	6100	8×8 8×11.5
	680	272	0.08	9	1929	6100	8×8 8×11.5
	820	328	0.08	9	1929	6100	8×8 8×11.5
	1000	800	0.08	9	1929	6100	8×11.5
	1200	960	0.08	9	1929 2100	6100 6640	8×11.5 10×12.5
	1500	1200	0.08	9	2100	6640	10×12.5
	2000	1600	0.08	9	2100	6640	10×12.5
	2500	2000	0.08	9	2100	6640	10×12.5
6.3	390	491.4	0.08	9	1929	6100	8×8 8×11.5
	470	592	0.08	9	1929	6100	8×8 8×11.5
	560	705.6	0.08	9	1929	6100	8×8 8×11.5
	680	428	0.08	9	1929	6100	8×8 8×11.5
	820	516.6	0.10	9	1929	6100	8×11.5
	1000	630	0.10	9	1929 2100	6100 6640	8×11.5 10×12.5
	1200	756	0.10	9	2100	6640	10×12.5
	1500	945	0.10	9	2100	6640	10×12.5
	2000	1260	0.10	9	2100	6640	10×12.5
10	390	390	0.08	9	1929	6100	8×11.5
	470	470	0.08	9	1929	6100	8×11.5
	560	560	0.10	9	1929	6100	8×11.5
	680	680	0.10	9	2100	6640	8×11.5 10×12.5
	820	820	0.10	9	2100	6640	10×12.5
	1000	1000	0.10	9	2100	6640	10×12.5
16	100	160	0.08	12	1518	4800	6.3×11
	180	288	0.08	10	1771	5600	8×11.5
	220	352	0.08	10	1771	5600	8×11.5
	270	432	0.08	10	1771	5600	8×11.5
	330	528	0.08	10	1771 1929	5600 6100	8×11.5 10×12.5
	390	624	0.08	10	1929	6100	10×12.5
	470	752	0.10	10	1929	6100	10×12.5
	560	896	0.10	10	1929	6100	10×12.5

Ripple Current (mA, rms) at 105°C, 100KHz

Size List

WV (SV) Cap(μF)	φ DxL(mm)				
	2.5 (2.8)	4 (4.6)	6.3 (7.2)	10 (11.5)	16 (18.4)
100					6.3×11
180					8×11.5
220					8×11.5
270					8×11.5
330					8×11.5/10×12.5
390			8×8/8×11.5	8×11.5	10×12.5
470			8×8/8×11.5	8×11.5	10×12.5
560		8×8/8×11.5	8×8/8×11.5	8×11.5	10×12.5
680		8×8/8×11.5	8×8/8×11.5	8×11.5/10×12.5	
820	8×8/8×11.5	8×8/8×11.5	8×11.5	10×12.5	
1000	8×11.5	8×11.5	8×11.5/10×12.5	10×12.5	
1200	8×11.5	8×11.5/10×12.5	10×12.5		
1500	8×11.5	10×12.5	10×12.5		
2000	10×12.5	10×12.5	10×12.5		
2500	10×12.5	10×12.5			
2700	10×12.5				

Ripple Current (mA, rms) at 105°C, 100KHz

PF series Long Life to 5,000Hours

Features

- ◆ Super Long Life to 5,000Hours.
- ◆ Low ESR at high frequency range.



Specifications

Item	Performance Characteristics	
Operating Temp. Range	-55°C ~ +105°C	
Capacitance Range	100 ~ 2700 μF	
Capacitance Tolerance	M : ±20%	
Rated Voltage Range	2.5V ~ 16V DC	
Dissipation Factor (at 120Hz, 20°C)	Not to exceed the value specified	
Leakage Current	≤ 0.2CV (μA, after 2 minutes)	
ESR (100K~300KHz)	Not to exceed the value specified	
Endurance 105°C · 5000h · at rated voltage	Capacitance Change	Within ±20% of the value before test
	Leakage current	Not to exceed the value specified
	ESR	Not to exceed 150% of the value specified
	Dissipation Factor	Not to exceed 150% of the value specified
Moisture Resistance Stored at 60°C · RH90~95% · 1000h	Capacitance Change	Within ±20% of the value before test
	Leakage Current	Not to exceed the value specified
	ESR	Not to exceed 150% of the value specified
	Dissipation Factor	Not to exceed 150% of the value specified

Frequency Coefficient for Ripple Current

Frequency	120Hz ≤ freq. < 1KHz	1KHz ≤ freq. < 10KHz	10KHz ≤ freq. < 100KHz	100KHz ≤ freq. < 300KHz
Coefficient	0.05	0.3	0.7	1

Diagram of Dimensions:(unit:mm)

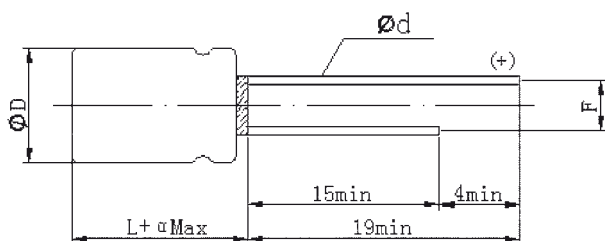

φD × L	φD + 0.5max.	α	F ± 0.5	φd ± 0.05
6.3 × 8	6.3	1.5	2.5	0.6
6.3 × 11	6.3	1.5	2.5	0.6
8 × 8	8.0	1.0	3.5	0.6
8 × 11.5	8.0	1.5	3.5	0.6
10 × 12.5	10.0	1.5	5.0	0.6

Dimensions & Characteristics

φ D×L(mm)

W.V. (V)	Capacitance (μF)	L.C. (μA,2min)	tg δ (120Hz,20°C)	ESR (mΩ,100KHZ)	Maximum Permissible Ripple Current(mA,r.m.s)	Size φD×L(mm)	
2.5	820	410	0.08	9	4500	6.3×8	
				9	6100	8×8	
	1000	500	0.08	0.08	9	6100	8×11.5
					9	6100	8×11.5
					9	6100	8×11.5
					9	6640	10×12.5
					9	6640	10×12.5
4	560	448	0.08	9	4500	6.3×8	
				9	6100	8×8	
	680	542	0.08	0.08	9	6100	8×11.5
					9	6100	8×8
	820	656	0.08	0.08	9	6100	8×11.5
					9	6100	10×12.5
					9	6100	8×11.5
9					6100	8×11.5	
9					6640	10×12.5	
6.3	390	491.4	0.08	9	6100	8×8	
				9	4100	8×11.5	
	470	592	0.08	0.08	9	6100	6.3×8
					9	6100	8×8
	560	705.6	0.08	0.08	9	4100	8×11.5
					9	6100	6.3×8
					9	6100	8×8
9					6100	8×11.5	
9					6100	8×11.5	
10	820	516.6	0.10	9	6100	8×8	
				9	6100	8×11.5	
	1000	630	0.10	0.10	9	6100	8×11.5
					9	6640	10×12.5
	1200	756	0.10	0.10	9	6100	8×11.5
					9	6640	10×12.5
					9	6640	10×12.5
16	100	160	0.08	15	3500	10×12.5	
				12	4800	6.3×11	
	180	288	0.08	0.08	12	5600	6.3×11
					10	5100	8×8
					10	5600	8×11.5
220	352	0.08	0.08	10	5600	10×12.5	
				10	5100	10×12.5	
				10	5600	10×12.5	
				10	5100	8×11.5	
				10	5600	10×12.5	
16	270	432	0.08	0.08	10	5100	8×11.5
					10	5600	10×12.5
	330	528	0.08	0.08	10	5600	8×11.5
					10	6100	10×12.5
					10	6100	10×12.5
	390	624	0.08	0.08	10	6100	10×12.5
					10	6100	10×12.5
470	752	0.10	0.10	10	6100	10×12.5	
				10	6100	10×12.5	
560	896	0.10	0.10	10	6100	10×12.5	
				10	6100	10×12.5	

Ripple Current (mA, rms) at 105°C, 100KHz

Conductive Polymer

Size List

WV (SV) Cap(μF)	φ DxL(mm)				
	2.5 (2.8)	4 (4.6)	6.3 (7.2)	10 (11.5)	16 (18.4)
100					6.3×8/6.3×11
180					6.3×11/8×8/8×11.5
220					8×8/8×11.5
270					8×8/8×11.5
330					8×11.5/10×12.5
390			8×8/8×11.5	8×8/8×11.5	10×12.5
470			6.3×8/8×8/8×11.5	8×8/8×11.5	10×12.5
560		6.3×8/8×8/8×11.5	6.3×8/8×8/8×11.5	8×8/8×11.5	10×12.5
680		8×8/8×11.5	8×8/8×11.5	8×11.5/10×12.5	
820	6.3×8/8×8/8×11.5	8×8/8×11.5/10×12.5	8×8/8×11.5	10×12.5	
1000	8×8/8×11.5	8×11.5	8×11.5/10×12.5	10×12.5	
1200	8×8/8×11.5	8×11.5/10×12.5	8×11.5/10×12.5		
1500	8×11.5	10×12.5	10×12.5		
2000	10×12.5	10×12.5	10×12.5		
2500	10×12.5	10×12.5			
2700	10×12.5				

Ripple Current (mA, rms) at 105°C, 100KHz

PM series SMD type & Low Profile

Features

- ◆ SMD type & Low profile
- ◆ Low ESR at high frequency range & Large permissible ripple current.



Specifications

Item	Performance Characteristics	
Operating Temperature Range	-55~+105°C	
Rated Voltage Range	2.5~25 VDC	
Capacitance Range	10 to 560 μF	
Capacitance Tolerance	±20%(120Hz, +20°C)	
Leakage Current (+20°C, max.)	Not to exceed the value specified (μA, after 2 minutes)	
Dissipation Factor (tan δ , at 20°C , 120Hz)	Not to exceed the value specified	
ESR (100K~300KHz)	Not to exceed the value specified	
Endurance 105°C , 2000h , at rated voltage	Capacitance Change	Within ±20% of the value before test
	Leakage current	Not to exceed the value specified
	ESR	Not to exceed 150% of the value specified
	Dissipation Factor	Not to exceed 150% of the value specified
Moisture Resistance Stored at 60°C , RH90~95% , 1000h	Capacitance Change	Within ±20% of the value before test
	Leakage current	Not to exceed the value specified
	ESR	Not to exceed 150% of the value specified
	Dissipation Factor	Not to exceed 150% of the value specified

Conductive Polymer

Frequency Coefficient for Ripple Current

Frequency	120Hz ≤ freq. < 1KHz	1KHz ≤ freq. < 10KHz	10KHz ≤ freq. < 100KHz	100KHz ≤ freq. < 300KHz
Coefficient	0.05	0.3	0.7	1

Recommended land pattern:(unit:mm)

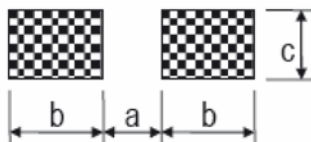

φD×L	a	b	c
4×5.5	1.0	2.6	1.6
5×5.5	1.4	3.0	1.6
6.3×5.8	2.1	3.5	1.6
6.3×7.7	2.1	3.5	1.6

Diagram of Dimensions:(unit:mm)

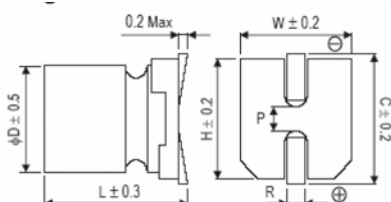

φD×L	W	H	C	R	P
4×5.5	4.3	4.3	5.1	0.5 to 0.8	1.0
5×5.5	5.3	5.3	5.9	0.5 to 0.8	1.4
6.3×5.8	6.5	6.5	7.2	0.5 to 0.8	2.1
6.3×7.7	6.5	6.5	7.2	0.5 to 0.8	2.1

Dimensions & Characteristics

W.V. (V)	Capacitance (μ F)	L.C. (μ A,2min)	tg δ (120Hz,20°C)	ESR (m Ω ,100KHZ)	Maximum Permissible Ripple Current(mA,r.m.s)	ϕ DxL(mm)
						Size Φ D x L (mm)
2.5	150	300	0.08	30	2200	6.3x5.8
	180	300	0.08	30	2200	6.3x5.8
	220	300	0.08	30	2610	6.3x5.8
	270	300	0.08	25	2610	6.3x5.8
				20	2690	6.3x7.7
	330	300	0.08	25	2610	6.3x5.8
				20	2690	6.3x7.7
	390	300	0.08	25	2610	6.3x5.8
				20	2690	6.3x7.7
470	300	0.08	25	2610	6.3x5.8	
			15	3100	6.3x7.7	
560	300	0.08	25	2610	6.3x5.8	
			15	3100	6.3x7.7	
4	150	300	0.08	30	2200	6.3x5.8
				25	2670	6.3x7.7
	180	300	0.08	30	2200	6.3x5.8
				25	2670	6.3x7.7
	220	300	0.08	25	2610	6.3x5.8
				20	2690	6.3x7.7
	270	300	0.08	25	2610	6.3x5.8
				20	2690	6.3x7.7
	330	300	0.08	20	2690	6.3x5.8
15				3100	6.3x7.7	
390	300	0.08	15	3100	6.3x7.7	
			15	3100	6.3x7.7	
6.3	47	300	0.08	30	1970	5x5.5
				30	1970	5x5.5
	56	300	0.08	30	1970	5x5.5
				20	2690	6.3x5.8
	68	300	0.08	30	1970	5x5.5
				20	2690	6.3x5.8
	82	300	0.08	30	1970	5x5.5
				20	2690	6.3x5.8
	100	300	0.08	25	2390	6.3x5.8
20				2690	6.3x7.7	
150	300	0.08	30	1970	5x5.5	
			25	2390	6.3x5.8	
180	300	0.08	20	2690	6.3x7.7	
			20	2690	6.3x7.7	
220	300	0.08	20	3000	6.3x5.8	
			15	3400	6.3x7.7	
270	300	0.08	20	3000	6.3x5.8	
			15	3400	6.3x7.7	
330	300	0.08	20	3100	6.3x5.8	
			15	3400	6.3x7.7	
390	300	0.08	15	3400	6.3x7.7	
			15	3400	6.3x7.7	
10	10	300	0.08	45	1200	4x5.5
	15	300	0.08	45	1200	4x5.5
	22	300	0.08	45	1200	4x5.5
	33	300	0.08	30	1970	5x5.5
				30	2200	6.3x5.8
	39	300	0.08	30	1970	5x5.5
				30	2200	6.3x5.8
	47	300	0.08	30	1970	5x5.5
				30	2200	6.3x5.8
	56	300	0.08	20	2690	6.3x7.7
				30	1970	5x5.5
	68	300	0.08	30	2200	6.3x5.8
				20	2690	6.3x7.7
	82	300	0.08	30	1970	5x5.5
				30	2200	6.3x5.8
	100	300	0.08	20	2690	6.3x7.7
				30	1970	5x5.5
	150	300	0.08	30	2200	6.3x5.8
				20	2690	6.3x7.7
	180	300	0.08	30	2200	6.3x5.8
				20	2690	6.3x7.7
	220	300	0.08	30	1970	5x5.5
20				2690	6.3x7.7	
270	300	0.08	30	1970	5x5.5	
			20	2690	6.3x7.7	
330	300	0.08	20	2690	6.3x7.7	
			20	2690	6.3x7.7	

Ripple Current (mA, rms) at 105°C, 100KHz

W.V. (V)	Capacitance (μ F)	L.C. (μ A, 2min)	tg δ (120Hz, 20°C)	ESR (m Ω , 100KHZ)	Maximum Permissible Ripple Current(mA, r.m.s)	Size Φ D \times L(mm)
16	10	400	0.08	30	2200	5 \times 5.8
				30	2200	6.3 \times 5.8
				25	2610	6.3 \times 7.7
	15	400	0.08	30	2200	5 \times 5.8
				30	2200	6.3 \times 5.8
				25	2610	6.3 \times 7.7
	22	400	0.08	30	2200	5 \times 5.8
				30	2200	6.3 \times 5.8
				25	2610	6.3 \times 7.7
	33	400	0.08	30	2200	5 \times 5.8
				30	2200	6.3 \times 5.8
				25	2610	6.3 \times 7.7
	39	400	0.08	30	2200	5 \times 5.8
				30	2200	6.3 \times 5.8
				25	2610	6.3 \times 7.7
47	400	0.08	30	2200	6.3 \times 5.8	
			25	2610	6.3 \times 7.7	
			30	2200	6.3 \times 5.8	
56	400	0.08	30	2200	6.3 \times 5.8	
			25	2610	6.3 \times 7.7	
			30	2200	6.3 \times 5.8	
68	400	0.08	20	2690	6.3 \times 7.7	
			30	2200	6.3 \times 5.8	
			20	2690	6.3 \times 7.7	
82	400	0.08	30	2200	6.3 \times 5.8	
			20	2690	6.3 \times 7.7	
			20	2690	6.3 \times 5.8	
100	400	0.08	20	2690	6.3 \times 5.8	
			20	2690	6.3 \times 7.7	
			20	2690	6.3 \times 7.7	
150	400	0.08	30	2200	6.3 \times 5.8	
			30	2670	6.3 \times 7.7	
			30	2200	6.3 \times 5.8	
15	600	0.08	25	2670	6.3 \times 7.7	
			30	2200	6.3 \times 5.8	
			25	2670	6.3 \times 7.7	
22	600	0.08	30	2200	6.3 \times 5.8	
			25	2670	6.3 \times 7.7	
			30	2200	6.3 \times 5.8	
33	600	0.08	25	2670	6.3 \times 7.7	
			25	2670	6.3 \times 7.7	
			25	2670	6.3 \times 7.7	
39	600	0.08	25	2670	6.3 \times 7.7	
			25	2670	6.3 \times 7.7	
			25	2670	6.3 \times 7.7	
47	600	0.08	25	2670	6.3 \times 7.7	
			25	2670	6.3 \times 7.7	
			25	2670	6.3 \times 7.7	
56	600	0.08	25	2670	6.3 \times 7.7	
			25	2670	6.3 \times 7.7	
			25	2670	6.3 \times 7.7	
10	600	0.08	30	2200	6.3 \times 5.8	
			25	2670	6.3 \times 7.7	
			30	2200	6.3 \times 5.8	
15	600	0.08	25	2670	6.3 \times 7.7	
			30	2200	6.3 \times 5.8	
			25	2670	6.3 \times 7.7	
22	600	0.08	30	2200	6.3 \times 5.8	
			25	2670	6.3 \times 7.7	
			25	2670	6.3 \times 7.7	
33	600	0.08	25	2670	6.3 \times 7.7	
			25	2670	6.3 \times 7.7	
			25	2670	6.3 \times 7.7	
39	600	0.08	25	2670	6.3 \times 7.7	
			25	2670	6.3 \times 7.7	
			25	2670	6.3 \times 7.7	

Ripple Current (mA, rms) at 105°C, 100KHz

Size List

ϕ D \times L(mm)

WV (SV) Cap (μ F)	2.5 (2.8)	4 (4.6)	6.3 (7.2)	10 (11.5)	16 (18.4)	20 (23)	25 (27.5)
10				4 \times 5.5	5 \times 5.5/6.3 \times 5.8/6.3 \times 7.7	6.3 \times 5.8/6.3 \times 7.7	6.3 \times 5.8/6.3 \times 7.7
15				4 \times 5.5	5 \times 5.5/6.3 \times 5.8/6.3 \times 7.7	6.3 \times 5.8/6.3 \times 7.7	6.3 \times 5.8/6.3 \times 7.7
22				4 \times 5.5	5 \times 5.5/6.3 \times 5.8/6.3 \times 7.7	6.3 \times 5.8/6.3 \times 7.7	6.3 \times 5.8/6.3 \times 7.7
33				5 \times 5.5/6.3 \times 5.8	5 \times 5.5/6.3 \times 5.8/6.3 \times 7.7	6.3 \times 5.8/6.3 \times 7.7	6.3 \times 7.7
39				5 \times 5.5/6.3 \times 5.8	5 \times 5.5/6.3 \times 5.8/6.3 \times 7.7	6.3 \times 7.7	6.3 \times 7.7
47			5 \times 5.5	5 \times 5.5/6.3 \times 5.8/6.3 \times 7.7	6.3 \times 5.8/6.3 \times 7.7	6.3 \times 7.7	
56			5 \times 5.5	5 \times 5.5/6.3 \times 5.8/6.3 \times 7.7	6.3 \times 5.8/6.3 \times 7.7	6.3 \times 7.7	
68			5 \times 5.5/6.3 \times 5.8	5 \times 5.5/6.3 \times 5.8/6.3 \times 7.7	6.3 \times 5.8/6.3 \times 7.7		
82			5 \times 5.5/6.3 \times 5.8	5 \times 5.5/6.3 \times 5.8/6.3 \times 7.7	6.3 \times 5.8/6.3 \times 7.7		
100			5 \times 5.5/6.3 \times 5.8/6.3 \times 7.7	5 \times 5.5/6.3 \times 5.8/6.3 \times 7.7	6.3 \times 5.8/6.3 \times 7.7		
150	6.3 \times 5.8	6.3 \times 5.8/6.3 \times 7.7	5 \times 5.5/6.3 \times 5.8/6.3 \times 7.7	6.3 \times 5.8/6.3 \times 7.7	6.3 \times 7.7		
180	6.3 \times 5.8	6.3 \times 5.8/6.3 \times 7.7	6.3 \times 5.8/6.3 \times 7.7	6.3 \times 5.8/6.3 \times 7.7			
220	6.3 \times 5.8	6.3 \times 5.8/6.3 \times 7.7	6.3 \times 5.8/6.3 \times 7.7	6.3 \times 5.8/6.3 \times 7.7			
270	6.3 \times 5.8/6.3 \times 7.7	6.3 \times 5.8/6.3 \times 7.7	6.3 \times 5.8/6.3 \times 7.7	6.3 \times 7.7			
330	6.3 \times 5.8/6.3 \times 7.7	6.3 \times 5.8/6.3 \times 7.7	6.3 \times 5.8/6.3 \times 7.7	6.3 \times 7.7			
390	6.3 \times 5.8/6.3 \times 7.7	6.3 \times 5.8/6.3 \times 7.7					
470	6.3 \times 5.8/6.3 \times 7.7	6.3 \times 5.8/6.3 \times 7.7					
560	6.3 \times 5.8/6.3 \times 7.7						

Ripple Current (mA, rms) at 105°C 100KHz

PD series SMD type & Large capacitance

Features

- ◆ SMD type & Large capacitance
- ◆ Ultra low ESR at high frequency range & Large permissible ripple current.
- ◆ Long life and high reliability(reliability: 0.1% / 1000Hrs).



Specifications

Item	Performance Characteristics	
Operating Temperature Range	-55~+105°C	
Rated Voltage Range	2.5~25 VDC	
Capacitance Range	39 to 3300 μF	
Capacitance Tolerance	±20%(120Hz,+20°C)	
Leakage Current (+20°C,max.)	Not to exceed the value specified (μ A, after 2 minutes)	
Dissipation Factor (tan δ , at 20°C , 120Hz)	Not to exceed the value specified	
ESR (100K~300KHz)	Not to exceed the value specified	
Endurance 105°C , 2000h , at rated voltage	Capacitance Change	Within ±20% of the value before test
	Leakage current	Not to exceed the value specified
	ESR	Not to exceed 150% of the value specified
	Dissipation Factor	Not to exceed 150% of the value specified
Moisture Resistance Stored at 60°C , RH90~95% , 1000h	Capacitance Change	Within ±20% of the value before test
	Leakage current	Not to exceed the value specified
	ESR	Not to exceed 150% of the value specified
	Dissipation Factor	Not to exceed 150% of the value specified

Frequency Coefficient for Ripple Current

Frequency	120Hz ≤ freq. < 1KHz	1KHz ≤ freq. < 10KHz	10KHz ≤ freq. < 100KHz	100KHz ≤ freq. < 300KHz
Coefficient	0.05	0.3	0.7	1

Recommended land pattern:(unit:mm)

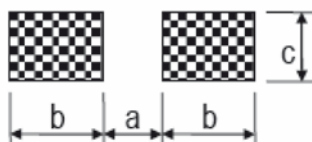

φD×L	a	b	c
8X11.7	2.8	4.2	1.9
10X12.4	4.3	4.4	1.9

Diagram of Dimensions:(unit:mm)

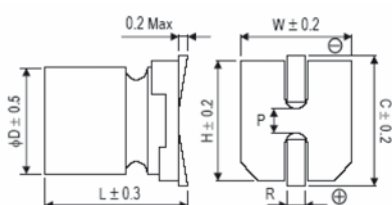

φD×L	W	H	C	R	P
8X11.7	8.3	8.3	9.0	0.8 to 1.1	3.2
10X12.4	10.3	10.3	11.0	0.8 to 1.1	4.6

Dimensions & Characteristics

W.V. (V)	Capacitance (μ F)	L.C. (μ A,2min)	tg δ (120Hz,20°C)	ESR (m Ω ,100KHz)	Maximum Permissible Ripple Current(mA,r.m.s)	ϕ DxL(mm)
						Size Φ D \times L(mm)
2.5	560	280	0.08	8	5200	8X11.7
	680	340	0.08	8	5200	8X11.7
	820	410	0.08	8	5200	8X11.7
	1000	500	0.08	8	5200	8X11.7
	1500	750	0.08	8	5200	8X11.7
	2000	1000	0.08	8	5500	10X12.4
	2500	1250	0.08	8	5500	10X12.4
	2700	1350	0.10	8	5500	10X12.4
	3000	1500	0.10	8	5500	10X12.4
	3300	1650	0.10	8	5500	10X12.4
4.0	560	448	0.08	8	5200	8X11.7
	680	544	0.08	8	5200	8X11.7
	820	656	0.08	8	5200	8X11.7
	1000	800	0.10	8	5200	8X11.7
	1200	960	0.10	8	5200	8X11.7
	1500	1200	0.10	8	5500	10X12.4
	2000	1600	0.10	8	5500	10X12.4
	2500	2000	0.10	8	5500	10X12.4
6.3	180	226.8	0.08	8	5200	8X11.7
	220	277.2	0.08	8	5200	8X11.7
	270	340.2	0.08	8	5200	8X11.7
	330	416	0.08	8	5200	8X11.7
	390	491	0.08	8	5200	8X11.7
	470	592	0.08	8	5200	8X11.7
	560	705.6	0.08	8	5200	8X11.7
	680	856	0.08	8	5200	8X11.7
	680	856	0.08	8	5500	10X12.4
	820	1033.2	0.10	8	5200	8X11.7
	820	1033.2	0.10	8	5500	10X12.4
	1000	1260	0.10	8	5200	8X11.7
	1000	1260	0.10	8	5500	10X12.4
	1200	1512	0.10	8	5500	10X12.4
	1500	1890	0.10	8	5500	10X12.4
	2000	2520	0.10	8	5500	10X12.4
10	180	360	0.08	8	5200	8 \times 11.7
	220	440	0.08	8	5200	8 \times 11.7
	270	540	0.08	8	5200	8 \times 11.7
	330	660	0.08	8	5200	8 \times 11.7
	390	780	0.08	8	5200	8 \times 11.7
	470	940	0.08	8	5200	8 \times 11.7
	560	1120	0.08	8	5200	8 \times 11.7
	560	1120	0.08	8	5500	10 \times 12.4
	680	1360	0.10	8	5200	8 \times 11.7
	680	1360	0.10	8	5500	10 \times 12.4
	820	1640	0.10	8	5500	10 \times 12.4
	1000	2000	0.10	8	5500	10 \times 12.4
1200	2400	0.10	8	5500	10 \times 12.4	
16	180	576	0.08	10	4700	8 \times 11.7
	220	704	0.08	10	4700	8 \times 11.7
	220	704	0.08	10	5100	10 \times 12.4
	270	864	0.08	10	4700	8 \times 11.7
	270	864	0.08	10	5100	10 \times 12.4
	330	1056	0.08	10	4700	8 \times 11.7
	330	1056	0.08	10	5100	10 \times 12.4
	470	1504	0.10	10	5100	10 \times 12.4
680	2176	0.10	10	5100	10 \times 12.4	
820	2624	0.10	10	5100	10 \times 12.4	

Conductive Polymer

Ripple Current (mA, rms) at 105°C, 100KHz

W.V. (V)	Capacitance (μ F)	L.C. (μ A,2min)	tg δ (120Hz,20°C)	ESR (m Ω ,100KHZ)	Maximum Permissible Ripple Current(mA,r.m.s)	Size Φ D \times L(mm)
20	39	156	0.08	15	4210	8 \times 11.7
	47	188	0.08	15	4210	8 \times 11.7
	68	272	0.08	15	4210	8 \times 11.7
	82	328	0.08	15	4210	8 \times 11.7
	100	400	0.08	15	4210	8 \times 11.7
				15	4800	10 \times 12.4
	150	600	0.10	15	4800	10 \times 12.4
	180	720	0.10	15	4800	10 \times 12.4
	220	880	0.10	15	4800	10 \times 12.4
	270	1080	0.10	15	4800	10 \times 12.4
330	1320	0.10	15	4800	10 \times 12.4	
25	39	195	0.08	15	4210	8 \times 11.7
	47	235	0.08	15	4210	8 \times 11.7
	68	340	0.08	15	4210	8 \times 11.7
	82	410	0.08	15	4210	8 \times 11.7
	100	500	0.10	15	4210	8 \times 11.7
				15	4800	10 \times 12.4
	150	750	0.10	15	4800	10 \times 12.4
	180	900	0.10	15	4800	10 \times 12.4
	220	1100	0.10	15	4800	10 \times 12.4
270	1350	0.10	15	4800	10 \times 12.4	

Ripple Current (mA, rms) at 105°C, 100KHz

Size List

ϕ D \times L(mm)

WV (SV) Cap(μ F)	2.5 (2.8)	4 (4.6)	6.3 (7.2)	10 (11.5)	16 (18.4)	20 (23)	25 (27.5)
39						8 \times 11.7	8 \times 11.7
47						8 \times 11.7	8 \times 11.7
68						8 \times 11.7	8 \times 11.7
82						8 \times 11.7	10 \times 12.4
100						8 \times 11.7/10 \times 12.4	10 \times 12.4
150						10 \times 12.4	10 \times 12.4
180			8 \times 11.7	8 \times 11.7	8 \times 11.7	10 \times 12.4	10 \times 12.4
220			8 \times 11.7	8 \times 11.7	8 \times 11.7/10 \times 12.4	10 \times 12.4	10 \times 12.4
270			8 \times 11.7	8 \times 11.7	8 \times 11.7/10 \times 12.4	10 \times 12.4	10 \times 12.4
330			8 \times 11.7	8 \times 11.7	8 \times 11.7/10 \times 12.4	10 \times 12.4	
390			8 \times 11.7	8 \times 11.7	10 \times 12.4		
470			8 \times 11.7	8 \times 11.7	10 \times 12.4		
560	8 \times 11.7	8 \times 11.7	8 \times 11.7	8 \times 11.7/10 \times 12.4	10 \times 12.4		
680	8 \times 11.7	8 \times 11.7	8 \times 11.7/10 \times 12.4	8 \times 11.7/10 \times 12.4	10 \times 12.4		
820	8 \times 11.7	8 \times 11.7	8 \times 11.7/10 \times 12.4	10 \times 12.4	10 \times 12.4		
1000	8 \times 11.7	8 \times 11.7	10 \times 12.4	10 \times 12.4			
1200	8 \times 11.7	8 \times 11.7	10 \times 12.4	10 \times 12.4			
1500	8 \times 11.7	10 \times 12.4	10 \times 12.4				
2000	10 \times 12.4	10 \times 12.4	10 \times 12.4				
2500	10 \times 12.4	10 \times 12.4					
2700	10 \times 12.4						
3000	10 \times 12.4						
3300	10 \times 12.4						

Ripple Current (mA, rms) at 105°C 100KHz

PV series SMD type & Low height

Features

- ◆ SMD type , Low height & Large capacitance
- ◆ Low ESR at high frequency range &.Large permissible ripple current.
- ◆ Long life and high reliability(reliability: 0.1% / 1000Hrs).



Specifications

Item	Performance Characteristics	
Operating Temperature Range	-55~+105°C	
Rated Voltage Range	2.5~25 VDC	
Capacitance Range	39 to 2500 μF	
Capacitance Tolerance	±20%(120Hz,+20°C)	
Leakage Current (+20°C,max.)	Not to exceed the value specified (μ A, after 2 minutes)	
Dissipation Factor (tan δ , at 20°C , 120Hz)	Not to exceed the value specified	
ESR (100K~300KHz)	Not to exceed the value specified	
Endurance 105°C , 2000h , at rated voltage	Capacitance Change	Within ±20% of the value before test
	Leakage current	Not to exceed the value specified
	ESR	Not to exceed 150% of the value specified
	Dissipation Factor	Not to exceed 150% of the value specified
Moisture Resistance Stored at 60°C , RH90~95% , 1000h	Capacitance Change	Within ±20% of the value before test
	Leakage current	Not to exceed the value specified
	ESR	Not to exceed 150% of the value specified
	Dissipation Factor	Not to exceed 150% of the value specified

Conductive Polymer

Frequency Coefficient for Ripple Current

Frequency	120Hz ≤ freq. < 1KHz	1KHz ≤ freq. < 10KHz	10KHz ≤ freq. < 100KHz	100KHz ≤ freq. < 300KHz
Coefficient	0.05	0.3	0.7	1

Recommended land pattern:(unit:mm)

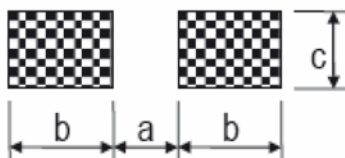

φD×L	a	b	c
8X7.7	2.8	4.2	1.9
8X10.5	2.8	4.2	1.9
10X8.7	4.3	4.4	1.9
10X10.5	4.3	4.4	1.9

Diagram of Dimensions:(unit:mm)

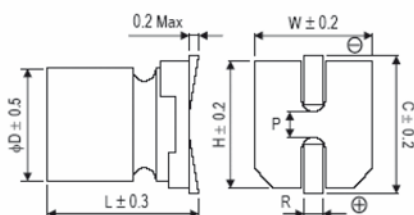

φD×L	W	H	C	R	P
8X7.7	8.3	8.3	9.0	0.8 to 1.1	3.2
8X10.5	8.3	8.3	9.0	0.8 to 1.1	3.2
10X8.7	10.3	10.3	11.0	0.8 to 1.1	4.6
10X10.5	10.3	10.3	11.0	0.8 to 1.1	4.6

Dimensions & Characteristics

W.V. (V)	Capacitance (μ F)	L.C. (μ A,2min)	tg δ (120Hz,20°C)	ESR (m Ω ,100KHZ)	Maximum Permissible Ripple Current(mA,r.m.s)	ϕ DxL(mm)
						Size Φ DxL(mm)
2.5	560	280	0.08	20	3500	8x7.7
				11	4800	8x10.5
	680	340	0.08	20	3500	8x7.7
				11	4800	8x10.5
	820	410	0.08	20	3500	8x7.7
				11	4800	8x10.5
	1000	500	0.08	11	4800	8x10.5
				20	3700	10x8.7
	1200	600	0.08	11	4800	8x10.5
20				3700	10x8.7	
1500	750	0.10	20	3700	10x8.7	
			11	5100	10x10.5	
2000	1000	0.10	11	5100	10x10.5	
2500	1250	0.10	11	5100	10x10.5	
4	560	448	0.08	20	3500	8x7.7
				11	4800	8x10.5
	680	544	0.08	20	3500	8x7.7
				11	4800	8x10.5
	820	656	0.08	11	4800	8x10.5
				20	3700	10x8.7
	1000	800	0.10	11	4800	8x10.5
20				3700	10x8.7	
1200	960	0.10	11	5100	10x10.5	
1500	1200	0.10	11	5100	10x10.5	
2000	1600	0.10	11	5100	10x10.5	
6.3	220	277.2	0.08	20	3500	8x7.7
				11	4800	8x10.5
	270	340.2	0.08	20	3500	8x7.7
				11	4800	8x10.5
	330	415.8	0.08	20	3500	8x7.7
				11	4800	8x10.5
	390	491	0.08	20	3500	8x7.7
				11	4800	8x10.5
	470	592	0.08	20	3500	8x7.7
				11	4800	8x10.5
560	705.6	0.08	11	4800	8x10.5	
			11	4800	8x10.5	
680	856	0.10	11	4800	8x10.5	
			11	5100	10x10.5	
820	1033.2	0.10	20	3700	10x8.7	
			11	5100	10x10.5	
1000	1260	0.10	20	3700	10x8.7	
			11	5100	10x10.5	
1200	1260	0.10	11	5100	10x10.5	
10	330	660	0.08	20	3500	8x7.7
				11	4800	8x10.5
	390	780	0.08	20	3500	8x7.7
				11	4800	8x10.5
	470	940	0.08	11	4800	8x10.5
				20	3700	10x8.7
	560	1120	0.08	20	3700	10x8.7
11				4800	10x10.5	
680	1360	0.10	20	3700	10x8.7	
			11	4800	10x10.5	
820	1640	0.10	11	5100	10x10.5	

Ripple Current (mA, rms) at 105°C, 100KHz

W.V. (V)	Capacitance (μ F)	L.C. (μ A, 2min)	tg δ (120Hz, 20°C)	ESR (m Ω , 100KHZ)	Maximum Permissible Ripple Current(mA, r.m.s)	Size Φ D \times L(mm)
16	180	288	0.08	20	3500	8 \times 7.7
				11	4800	8 \times 10.5
	220	352	0.08	20	3500	8 \times 7.7
				11	4800	8 \times 10.5
	270	432	0.10	11	4800	8 \times 10.5
				11	5100	10 \times 10.5
	330	528	0.10	20	3700	10 \times 8.7
				11	5100	10 \times 10.5
	390	624	0.10	20	3700	10 \times 8.7
				11	5100	10 \times 10.5
	470	752	0.10	11	5100	10 \times 10.5
	20	68	272	0.08	20	3500
82		328	0.08	20	3500	8 \times 10.5
100		400	0.08	20	3500	8 \times 10.5
150		600	0.10	20	3500	8 \times 10.5
				25	3100	10 \times 8.7
180		720	0.10	25	3100	10 \times 8.7
				20	3700	10 \times 10.5
220		880	0.10	25	3100	10 \times 8.7
	20			3700	10 \times 10.5	
270	1080	0.10	20	3700	10 \times 10.5	
25	68	340	0.08	20	3500	8 \times 10.5
	82	410	0.10	20	3500	8 \times 10.5
				25	3100	10 \times 8.7
	100	500	0.10	25	3100	10 \times 8.7
				20	3700	10 \times 10.5
150	750	0.10	20	3700	10 \times 10.5	

Ripple Current (mA, rms) at 105°C, 100KHz

Size List

WV(SV) Cap(μ F)	2.5 (2.8)	4 (4.6)	6.3 (7.2)	10 (11.5)	16 (18.4)	20 (23)	25 (27.5)
68						8 \times 10.5	8 \times 10.5
82						8 \times 10.5	8 \times 10.5/10 \times 8.7
100						8 \times 10.5	10 \times 8.7/10 \times 10.5
150						8 \times 10.5/10 \times 8.7	10 \times 10.5
180					8 \times 7.7/8 \times 10.5	10 \times 8.7/10 \times 10.5	
220			8 \times 7.7/8 \times 10.5		8 \times 7.7/8 \times 10.5	10 \times 8.7/10 \times 10.5	
270			8 \times 7.7/8 \times 10.5		8 \times 10.5/10 \times 10.5	10 \times 10.5	
330			8 \times 7.7/8 \times 10.5	8 \times 7.7/8 \times 10.5	10 \times 8.7/10 \times 10.5		
390			8 \times 7.7/8 \times 10.5	8 \times 7.7/8 \times 10.5	10 \times 8.7/10 \times 10.5		
470			8 \times 7.7/8 \times 10.5	8 \times 10.5/10 \times 8.7	10 \times 10.5		
560	8 \times 7.7/8 \times 10.5	8 \times 7.7/8 \times 10.5	8 \times 10.5	10 \times 8.7/10 \times 10.5			
680	8 \times 7.7/8 \times 10.5	8 \times 7.7/8 \times 10.5	8 \times 10.5/10 \times 10.5	10 \times 8.7/10 \times 10.5			
820	8 \times 7.7/8 \times 10.5	8 \times 10.5/10 \times 8.7	10 \times 8.7/10 \times 10.5	10 \times 10.5			
1000	8 \times 10.5/10 \times 8.7	8 \times 10.5/10 \times 8.7	10 \times 8.7/10 \times 10.5				
1200	8 \times 10.5/10 \times 8.7	10 \times 10.5	10 \times 10.5				
1500	10 \times 8.7/10 \times 10.5	10 \times 10.5					
2000	10 \times 10.5	10 \times 10.5					
2500	10 \times 10.5						

Ripple Current (mA, rms) at 105°C, 100KHz

EV Series

Features

- ◆ Chip type long life capacitance in large case sizes
- ◆ Chip type with Endurance of 1000 hours at +105°C
- ◆ Designed for surface mounting on high density PC board
- ◆ Applicable to automatic insertion machine using carrier tape
- ◆ RoHS Compliant



Specifications

Item	Performance Characteristics													
Operating Temperature Range	-55~ +105°C													
Rated Voltage Range	6.3~50 VDC													
Capacitance Range	0.1 to 1500 μ F													
Capacitance Tolerance	$\pm 20\%$ (120Hz,+20°C)													
Leakage Current (+20°C,max.)	$I \leq 0.01$ CV or 3 (μ A) After 2 minutes whichever is greater measured with rated working voltage applied.													
Dissipation Factor ($\tan \delta$, at 20°C , 120Hz)	Working voltage(VDC) 6.3 10 16 25 35 50													
	D.F.(%)max <table border="1"> <tr> <td>ϕ 4~6.3</td> <td>30</td> <td>24</td> <td>20</td> <td>18</td> <td>16</td> <td>14</td> </tr> <tr> <td>ϕ 8~10</td> <td>35</td> <td>28</td> <td>24</td> <td>18</td> <td>16</td> <td>14</td> </tr> </table>	ϕ 4~6.3	30	24	20	18	16	14	ϕ 8~10	35	28	24	18	16
ϕ 4~6.3	30	24	20	18	16	14								
ϕ 8~10	35	28	24	18	16	14								
Low Temperature Characteristics (at 120Hz)	Impedance ratio max Working voltage(VDC) 6.3 10 16 25 35 50													
	<table border="1"> <tr> <td>Z-25°C / Z+20°C</td> <td>4</td> <td>3</td> <td>2</td> <td>2</td> <td>2</td> <td>2</td> </tr> <tr> <td>Z-40°C / Z+20°C</td> <td>8</td> <td>8</td> <td>4</td> <td>4</td> <td>3</td> <td>3</td> </tr> </table>	Z-25°C / Z+20°C	4	3	2	2	2	2	Z-40°C / Z+20°C	8	8	4	4	3
Z-25°C / Z+20°C	4	3	2	2	2	2								
Z-40°C / Z+20°C	8	8	4	4	3	3								
Endurance	Test condition Duration time :1000 Hrs Ambient temperature :+105°C Applied voltage :Rated DC working voltage After test requirement at +20°C Capacitance change : Within $\pm 25\%$ of initial value for capacitance of 16V or less : Within $\pm 20\%$ of initial value for capacitance of 25V or more Dissipation factor : Less than 200% of specified value Leakage current : Less than specified value													
Shelf Life	Test condition Duration time :1000 Hrs Ambient temperature :+105°C Applied voltage :None After test requirement at +20°C :Same limits as Endurance. Pre-treatment for measurements shall be conducted after application of DC working voltage for 30 minutes.													
Resistance to soldering heat	The capacitors shall be kept on the hot plate maintained at 250°C for 30 seconds. After removing from the hot plate and restored at room temperature, they meet the characteristic requirements listed under.													
	Leakage current	Less than specified value												
	Capacitance change	Within $\pm 10\%$ of initial value												
	$\tan \delta$	Less than specified value												

Multiplier for Ripple Current vs. Frequency

CAP(μ F)\Frequency(Hz)	60(50)	120	500	1K	$\geq 10K$
$0.1 \leq CAP \leq 100 \mu F$	0.8	1.0	1.20	1.30	1.50
$100 < CAP \leq 1500 \mu F$	0.8	1.0	1.10	1.15	1.20

Diagram of Dimensions:(unit:mm)

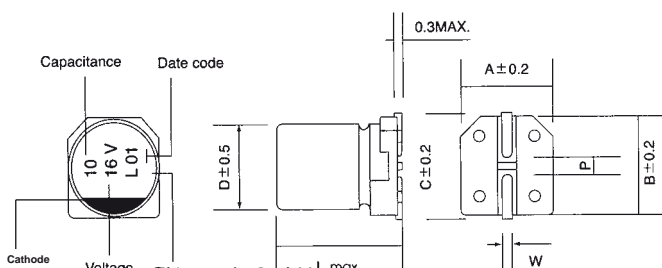

ϕD	L	A	B	C	W	P
4	5.5	4.3	4.3	4.9	0.5~0.8	1.0
5	5.5	5.3	5.3	5.9	0.5~0.8	1.4
6.3	5.5	6.6	6.6	7.2	0.5~0.8	2.2
6.3	7.7	6.6	6.6	7.2	0.5~0.8	2.2
8	6.5	8.3	8.3	9.0	0.5~0.8	2.3
8	10.5	8.3	8.3	9.0	0.7~1.1	3.1
10	10.5	10.3	10.3	11.0	0.7~1.1	4.5

Case Size

φ D x L (mm)

WV Cap (μF)	6.3		10		16		25		35		50	
	Size	Ripple	Size	Ripple	Size	Ripple	Size	Ripple	Size	Ripple	Size	Ripple
0.1											4X5.5	1.0
0.22											4X5.5	2.6
0.33											4X5.5	3.2
0.47											4X5.5	3.8
1.0											4X5.5	6.3
2.2											4X5.5	11
3.3											4X5.5	14
4.7							4X5.5	16	4X5.5	16	5X5.5	22
10					4X5.5	18	4X5.5	26	4X5.5	27	6.3X5.5	33
22	4X5.5	22	4X5.5	27	4X5.5	30	5X5.5	38	6.3X5.5	42	6.3X5.5	51
33	4X5.5	30	4X5.5	25	5X5.5	40	5X5.5	48	6.3X5.5	50	6.3X7.7	60
			5X5.5	40					6.3X7.7	58	8X6.5	60
47	4X5.5	36	5X5.5	46	5X5.5	51	6.3X5.5	63	6.3X7.7	66	6.3X7.7	66
											8X6.5	66
100	5X5.5	60	6.3X5.5	60	6.3X5.5	60	6.3X7.7	91	6.3X7.7	84	8X10.5	140
							8X6.5	91	8X6.5	84		
150	6.3X5.5	86	6.3X5.5	86	6.3X7.7	95	8X10.5	140	8X10.5	155	10X10.5	180
					8X6.5	95						
220	6.3X7.7	102	6.3X7.7	105	6.3X7.7	105	8X10.5	155	10X10.5	190	10X10.5	220
	8X6.5	102	8X6.5	105								
330	6.3X7.7	105	8X10.5	195	8X10.5	195	8X10.5	175	10X10.5	300		
	8X6.5	105					10X10.5	198				
470	8X10.5	210	8X10.5	210	8X10.5	210	10X10.5	300				
1000	10X10.5	230	10X10.5	310								
1500	10X10.5	310										

Ripple Current (mA, rms) at 105°C 120Hz

LV Series

Features

- ◆ 85°C standard, case diameter ϕ 4~ ϕ 10mm
- ◆ Reflow soldering is available
- ◆ Available for high density mounting
- ◆ RoHS Compliant



Specifications

Item	Performance Characteristics																														
Operating Temperature Range	-40~ +85°C																														
Rated Voltage Range	4~50 VDC																														
Capacitance Range	0.1 to 6800 μ F																														
Capacitance Tolerance	\pm 20%(120Hz,+20°C)																														
Leakage Current (+20°C,max.)	$I \leq 0.01$ CV or 3 (μ A) After 2 minutes, whichever is greater measured with rated working voltage applied																														
Dissipation Factor ($\tan \delta$, at 20°C , 120Hz)	<table border="1"> <tr> <td>Rated voltage(VDC)</td> <td>4</td> <td>6.3</td> <td>10</td> <td>16</td> <td>25</td> <td>35</td> <td>50</td> </tr> <tr> <td rowspan="3">D.F.(%)max</td> <td>ϕ 4~6.3</td> <td>42</td> <td>30</td> <td>22</td> <td>18</td> <td>16</td> <td>14</td> </tr> <tr> <td>ϕ 8~10</td> <td>45</td> <td>34</td> <td>26</td> <td>20</td> <td>16</td> <td>14</td> </tr> <tr> <td>$\geq \phi$ 12.5</td> <td>45</td> <td>40</td> <td>36</td> <td>24</td> <td>18</td> <td>15</td> </tr> </table>	Rated voltage(VDC)	4	6.3	10	16	25	35	50	D.F.(%)max	ϕ 4~6.3	42	30	22	18	16	14	ϕ 8~10	45	34	26	20	16	14	$\geq \phi$ 12.5	45	40	36	24	18	15
	Rated voltage(VDC)	4	6.3	10	16	25	35	50																							
	D.F.(%)max	ϕ 4~6.3	42	30	22	18	16	14																							
ϕ 8~10		45	34	26	20	16	14																								
$\geq \phi$ 12.5		45	40	36	24	18	15																								
Low Temperature Characteristics (at 120Hz)	Impedance ratio max																														
	Rated voltage(VDC)	4	6.3	10	16	25	35	50																							
	Z-25°C / Z+20°C	7	4	3	2	2	2	2																							
	Z-40°C / Z+20°C	15	8	8	4	4	3	3																							
Endurance	Test conditions																														
	Duration time :2000 Hrs Ambient temperature :+85°C Applied voltage :Rated DC working voltage After test requirement at +20°C: Capacitance change :Within \pm 25% of the initial value Dissipation factor :Not more than 200% of specified value Leakage current :Not more than the specified value																														
Shelf Life	Test conditions																														
	Duration time :1000 Hrs Ambient temperature :+85°C Applied voltage :None After test requirement at +20°C : Same limits as Endurance. Pre-treatment for measurements shall be conducted after application of DC working voltage for 30 minutes.																														
Resistance to soldering heat	The capacitors shall be kept on the hot plate maintained at 250°C for 30 seconds. After removing from the hot plate and restored at room temperature, they meet the characteristic requirements listed under.																														
	Leakage current	Less than specified value																													
	Capacitance change	Within \pm 10% of initial value																													
	$\tan \delta$	Less than specified value																													

Multiplier for Ripple Current vs. Frequency

CAP(μ F) \ Frequency(Hz)	60(50)	120	500	1K	\geq 10K
$0.1 \leq \text{CAP} \leq 100 \mu\text{F}$	0.8	1.0	1.20	1.30	1.50
$100 < \text{CAP}$	0.8	1.0	1.10	1.15	1.20

Diagram of Dimensions:(unit:mm)

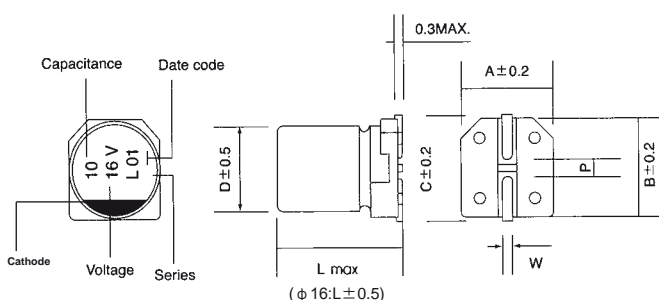

ϕD	L	A	B	C	W	P
4	5.5	4.3	4.3	4.9	0.5~0.8	1.0
5	5.5	5.3	5.3	5.9	0.5~0.8	1.4
6.3	5.5	6.6	6.6	7.2	0.5~0.8	2.2
6.3	6.1	6.6	6.6	7.2	0.5~0.8	2.2
6.3	7.7	6.6	6.6	7.2	0.5~0.8	2.2
8	6.5	8.3	8.3	9.0	0.5~0.8	2.3
8	10.5	8.3	8.3	9.0	0.7~1.1	3.1
10	10.5	10.3	10.3	11.0	0.7~1.1	4.5
12.5	14	13.5	13.5	15.0	1.0~1.4	5.5
16	17	17.1	17.1	18.0	1.0~1.4	6.3

Case Size

φ DxL(mm)

WV(V) Cap(uF)	4		6.3		10		16		25		35		50	
	Size	Ripple	Size	Ripple	Size	Ripple	Size	Ripple	Size	Ripple	Size	Ripple	Size	Ripple
0.1													4X5.5	1.0
0.22													4X5.5	2.0
0.33													4X5.5	2.8
0.47													4X5.5	4.0
1													4X5.5	8.4
2.2													4X5.5	14
3.3													4X5.5	17
4.7													4X5.5	22
10					4X5.5	21	4X5.5	23	4X5.5	27	4X5.5	29	6.3X5.5	35
22			4X5.5	29	4X5.5 5X5.5	33 37	4X5.5	37	5X5.5 6.3X5.5	40	5X5.5 6.3X5.5	45 48	6.3x6.1 6.3X7.7 8X6.5	60 75 80
33			4X5.5 5X5.5	33 37	4X5.5 5X5.5	41 43	5X5.5	45	5X5.5 6.3X5.5	46 54	6.3X5.5	58	6.3X7.7 8X6.5	188 200
47	4X5.5	28	4X5.5 5X5.5	40 46	5X5.5	52	5X5.5 6.3X5.5	50 60	6.3X5.5 6.3x6.1	60 68	6.3X5.5 6.3x6.1 8X6.5	65 70 115	6.3X7.7 8X6.5	225 240
100	5x5.5	34	5X5.5 6.3x6.1	70 85	6.3X5.5	76	6.3X5.5 6.3x6.1	100 108	6.3X7.7 8X6.5	150 160	6.3X7.7 8X10.5	250 280	8X10.5	300
150	6.3x6.1	50	6.3x6.1	100	6.3x6.1	88	6.3x7.7	135	8x10.5	200	8x10.5	300	10x10.5	320
220	6.3X5.5	61	6.3x6.1 6.3X7.7 8X6.5	130 141 150	6.3X7.7 8X6.5	170 190	6.3X7.7 8X10.5	185 290	8X10.5	300	10X10.5	400	10X10.5	450
330	6.3X7.7 8X6.5	135 145	6.3X7.7 8X6.5	197 210	8X10.5	330	8X10.5	330	10X10.5	450	10X10.5	460	12.5x14	520
470	8X6.5 8X10.5	180 220	8X10.5	380	8X10.5	420	10X10.5	480	10X10.5	460	12.5x14	590	16x17	925
560	8X10.5	242	8X10.5	410	10X10.5	450	10X10.5	500	12.5x14	520	12.5x14	600		
680	8X10.5	285	8X10.5	460	10X10.5	480	10x10.5	550	12.5x14	580	12.5x14	610		
1000	10X10.5	370	10X10.5	500	10X10.5	510	12.5x14	600	12.5x14	660			16x17	940
1200	10X10.5	410	10X10.5	510			12.5x14	660						
1500	10X10.5	470	10X10.5	530			12.5x14	710			16x17	1060		
2200					12.5x14	730			16x17	1150				
3300			12.5x14	750			16x17	1200						
4700					16x17	1200								
6800			16x17	1330										

SMD

Ripple Current (mA, rms) at 85°C 120Hz

HV Series

Features

- ◆ Long life of 2000 hrs at 105°C
- ◆ Reflow soldering is available
- ◆ Available for high density mounting
- ◆ RoHS Compliant



Specifications

Item	Performance Characteristics								
Operating Temperature Range	-55 +105°C								
Rated Voltage Range	6.3~63 VDC								
Capacitance Range	0.1 to 6800 μF								
Capacitance Tolerance	±20%(120Hz,+20°C)								
Leakage Current (+20°C,max.)	I ≤ 0.01 CV or 3 (μA) After 2 minutes, whichever is greater measured with rated working voltage applied								
Dissipation Factor (tan δ , at 20°C , 120Hz)	Working voltage(VDC)	6.3	10	16	25	35	50	63	
	D.F.(%)max	φ 4~6.3	30	24	20	16	14	14	12
		φ 8~10	35	26	24	18	14	14	12
Low Temperature Characteristics (at 120Hz)	Impedance ratio max								
	Rated voltage(VDC)	6.3	10	16	25	35	50	63	
	Z-25°C/Z+20°C	6	4	4	3	2	2	2	
	Z-40°C/Z+20°C	12	10	8	6	4	4	4	
Endurance	Test conditions Duration time :2000 Hrs Ambient temperature :+105°C Applied voltage :Rated DC working voltage After test requirement at +20°C: Capacitance change :Within ±30% of the initial value Dissipation factor :Not more than 300% of specified value Leakage current :Not more than the specified value								
Shelf Life	Test conditions Duration time :1000 Hrs Ambient temperature :+105°C Applied voltage :None After test requirement at +20°C : Same limits as Endurance. Pre-treatment for measurements shall be conducted after application of DC working voltage for 30 minutes.								
Resistance to soldering heat	The capacitors shall be kept on the hot plate maintained at 250°C for 30 seconds. After removing from the hot plate and restored at room temperature, they meet the characteristic requirements listed under.								
	Leakage current	Less than specified value							
	Capacitance change	Within ±10% of initial value							
	tan δ	Less than specified value							

Multiplier for Ripple Current vs. Frequency

CAP(μF)\Frequency(Hz)	60(50)	120	500	1K	≥10K
0.1 ≤ CAP ≤ 100 μF	0.8	1.0	1.20	1.30	1.50
100 < CAP	0.8	1.0	1.10	1.15	1.20

Diagram of Dimensions:(unit:mm)

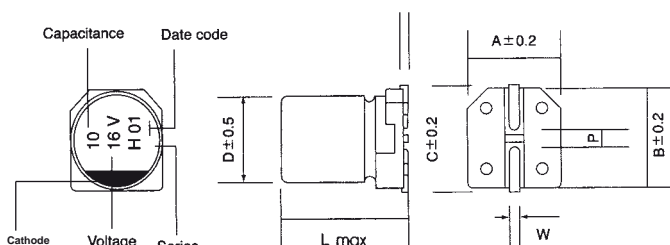

(φ 16:L±0.5)

φD	L	A	B	C	W	P
4	5.5	4.3	4.3	4.9	0.5~0.8	1.0
5	5.5	5.3	5.3	5.9	0.5~0.8	1.4
6.3	5.5	6.6	6.6	7.2	0.5~0.8	2.2
6.3	7.7	6.6	6.6	7.2	0.5~0.8	2.2
8	6.5	8.3	8.3	9.0	0.5~0.8	2.3
8	10.5	8.3	8.3	9.0	0.7~1.1	3.1
10	10.5	10.3	10.3	11.0	0.7~1.1	4.5
12.5	14	13.5	13.5	15.0	1.0~1.4	5.5
16	17	17.1	17.1	18.0	1.0~1.4	6.3

Case Size

φ DxL(mm)

WV(V) Cap(μF)	6.3		10		16		25		35		50		63	
	Size	Ripple	Size	Ripple	Size	Ripple	Size	Ripple	Size	Ripple	Size	Ripple	Size	Ripple
0.1											4x5.5	1.0	4x5.5	0.7
0.22											4x5.5	2.0	4x5.5	1.6
0.33											4x5.5	3.0	4x5.5	2.5
0.47											4x5.5	4.0	4x5.5	3.5
1											4x5.5	8.4	4x5.5	7
2.2											4x5.5	11	4x5.5	11
3.3											4x5.5	13	5x5.5	14
4.7							4x5.5	12	4x5.5	14	4x5.5	18	5x5.5	22
10					4x5.5	20	4x5.5	22	4x5.5	24	6.3x5.5	28	6.3x5.5	40
22	4x5.5	23	4x5.5	25	4x5.5 5x5.5	31 35	5x5.5	38	5x5.5 6.3x5.5	40 46	6.3x7.7 8x6.5	50 55	6.3x7.7	58
33	4x5.5	28	4x5.5	34	5x5.5 6.3x5.5	36 40	6.3x5.5	48	6.3x7.7 8x6.5	47 50	6.3x7.7 8x10.5	95 135	8x10.5	112
47	4x5.5 5x5.5	37 40	5x5.5	42	5x5.5 6.3x5.5	45 56	6.3x7.7 8x6.5	56 60	6.3x7.7 8x6.5	60 65	6.3x7.7 8x10.5	115 155	8x10.5	119
100	5x5.5 6.3x5.5	46 57	6.3x5.5 8x6.5	55 60	6.3x7.7 8x6.5	58 62	6.3x7.7 8x10.5	110 160	6.3x7.7 8x10.5	130 180	10x10.5	315	10x10.5	280
150	6.3x5.5 8x6.5	70 90	6.3x5.5 8x6.5	90 110	6.3x7.7 8x6.5	125 140	8x10.5	175	8x10.5	190	10x10.5	330		
220	6.3x7.7 8x6.5	90 130	6.3x7.7 8x6.5	140 160	6.3x7.7 8x10.5	170 185	8x10.5 10x10.5	180 190	8x10.5 10x10.5	250 280	10x10.5	350	12.5x14	300
330	6.3x7.7 8x10.5	140 170	8x10.5	195	8x10.5	250	8x10.5	290	10x10.5	360	12.5x14	400		
470	8x10.5	210	8x10.5 10x10.5	350 420	8x10.5 10x10.5	370 420	10x10.5	440	12.5x14	460	16x17	570	16x17	630
560	8x10.5	310	10x10.5	450	10x10.5	480	12.5x14	490	12.5x14	500				
680	10x10.5	370	10x10.5	480	10x10.5	540	12.5x14	510						
1000	10x10.5	480	10x10.5	530	12.5x14	580	12.5x14	600			16x17	655		
1200	10x10.5	500	12.5x14	570	12.5x14	590								
1500	10x10.5	520	12.5x14	750	12.5x14	620			16x17	740				
1800	12.5x14	600												
2200	12.5x14	650					16x17	805						
3300	12.5x14	700			16x17	850								
4700			16x17	880										
6800	16x17	930												

Ripple Current (mA, rms) at 105°C

SMD

JV Series Long Life, High CV

Features

- ◆ Chip type long life capacitance in large case sizes
- ◆ Chip type with Endurance of 3000 hours at +105°C
- ◆ Designed for surface mounting on high density PC board
- ◆ Applicable to automatic insertion machine using carrier tape
- ◆ RoHS Compliant



Specifications

Item	Performance Characteristics						
Operating Temperature Range	-55~+105°C						
Rated Voltage Range	6.3~50 VDC						
Capacitance Range	0.1 to 1000 μF						
Capacitance Tolerance	±20%(120Hz,+20°C)						
Leakage Current (+20°C,max.)	$I \leq 0.01 CV$ or $3 (\mu A)$ After 2 minutes whichever is greater measured with rated working voltage applied.						
Dissipation Factor ($\tan \delta$, at 20°C , 120Hz)	Working Voltage(VDC)	6.3	10	16	25	35	50
	D.F.(%)max.	28	24	20	16	13	12
Low Temperature Characteristics (at 120Hz)	Impedance ratio max (at: 120Hz)						
	Working voltage(VDC)	6.3	10	16	25	35	50
	Z-25°C / Z+20°C	4	3	2	2	2	2
	Z-40°C / Z+20°C	10	7	5	3	3	3
Endurance	Test condition Duration time : 3000 Hrs Ambient temperature : +105°C Applied voltage : Rated DC working voltage						
	After test requirement at +20°C Capacitance change : Within ±30% of initial value Dissipation factor : Less than 300% of specified value Leakage current : Less than specified value						
Shelf Life	Test condition Duration time : 1000 Hrs Ambient temperature : +105°C Applied voltage : None						
	After test requirement at +20°C: Same limits as Endurance. Pre-treatment for measurements shall be conducted after application of DC working voltage for 30 minutes.						
Resistance to soldering heat	The following specifications shall be satisfied when the capacitors are restored to 20°C after exposing them at 250°C for 30 seconds.						
	Leakage current	Less than specified value					
	Capacitance change	Within ±10% of initial value					
	$\tan \delta$	Less than specified value					

Multiplier for Ripple Current vs. Frequency

CAP(μ F) \ Frequency(Hz)	60(50)	120	500	1K	≥ 10K
$0.1 \leq CAP \leq 100 \mu F$	0.8	1.0	1.20	1.30	1.50
$100 < CAP \leq 1000 \mu F$	0.8	1.0	1.10	1.15	1.20

Diagram of Dimensions:(unit:mm)

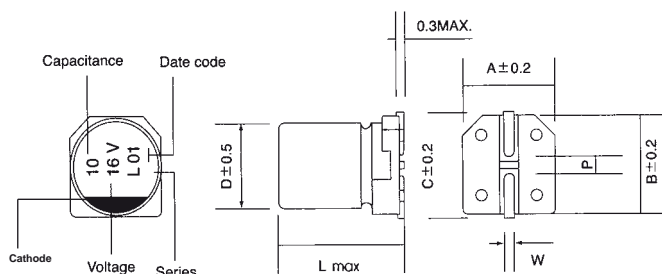

φD	L	A	B	C	W	P
4	5.5	4.3	4.3	4.9	0.5~0.8	1.0
5	5.5	5.3	5.3	5.9	0.5~0.8	1.4
6.3	5.5	6.6	6.6	7.2	0.5~0.8	2.2
6.3	7.7	6.6	6.6	7.2	0.5~0.8	2.2
8	6.5	8.3	8.3	9.0	0.5~0.8	2.3
8	10.5	8.3	8.3	9.0	0.7~1.1	3.1
10	10.5	10.3	10.3	11.0	0.7~1.1	4.5

Case Size

φ DxL(mm)

WV Cap(μF)	6.3		10		16		25		35		50	
	Size	Ripple	Size	Ripple	Size	Ripple	Size	Ripple	Size	Ripple	Size	Ripple
0.1											4X5.5	1.0
0.22											4X5.5	2.6
0.33											4X5.5	3.2
0.47											4X5.5	5.0
1.0											4X5.5	8.0
2.2											4X5.5	12
3.3											4X5.5	17
4.7							4X5.5	16	4X5.5	16	5X5.5	22
10					4X5.5	18	4X5.5	26	5X5.5	27	6.3X5.5	33
22	4X5.5	22	5X5.5	30	5X5.5	31	6.3X5.5	44	6.3X5.5	45	6.3X7.7	58
33	5X5.5	33	5X5.5	35	6.3X5.5	48	6.3X5.5	50	6.3X7.7	58	8X10.5	140
47	5X5.5	36	6.3X5.5	52	6.3X5.5	51	6.3X7.7	66	8X10.5	93	8X10.5	170
100	6.3X5.5	68	6.3X7.7	81	6.3X7.7	83	8X10.5	118	10X10.5	155	10X10.5	300
220	6.3X7.7	120	8X10.5	142	10X10.5	222	10X10.5	300	10X10.5	340		
330	8X10.5	230	10X10.5	280	10X10.5	305	10X10.5	395				
470	10X10.5	290	10X10.5	305	10X10.5	330						
1000	10X10.5	360										

Ripple Current (mA, rms) at 105°C 120Hz

MV Series Chip type ,Long Life, High CV

Features

- ◆ Chip type long life capacitance in large case sizes
- ◆ Chip type with Endurance of 5000 hours at +105°C
- ◆ Designed for surface mounting on high density PC board
- ◆ Applicable to automatic insertion machine using carrier tape
- ◆ Complied to the RoHS directive
- ◆ RoHS Compliant



Specifications

Item	Performance Characteristics						
Operating Temperature Range	-40~+105°C						
Rated Voltage Range	6.3~50 VDC						
Capacitance Range	0.1 to 1000 μ F						
Capacitance Tolerance	$\pm 20\%$ (120Hz,+20°C)						
Leakage Current (+20°C,max.)	$I \leq 0.01$ CV or 3 (μ A)After 2 minutes whichever is greater measured with rated working voltage applied.						
Dissipation Factor (tan δ , at 20°C , 120Hz)	Working Voltage(VDC)	6.3	10	16	25	35	50
	D.F.(%)max.	32	28	22	16	13	12
Low Temperature Characteristics (at 120Hz)	Impedance ratio max (at: 120Hz)						
	Working voltage(VDC)	6.3	10	16	25	35	50
	Z-25°C / Z+20°C	4	3	2	2	2	2
	Z-40°C / Z+20°C	10	7	5	3	3	3
Endurance	Test condition Duration time : 5000 Hrs Ambient temperature : +105°C Applied voltage : Rated DC working voltage						
	After test requirement at +20°C Capacitance change : Within $\pm 30\%$ of initial value Dissipation factor : Less than 300% of specified value Leakage current : Less than specified value						
Shelf Life	Test condition Duration time : 1000 Hrs Ambient temperature : +105°C Applied voltage : None						
	After test requirement at +20°C : Same limits as Endurance. Pre-treatment for measurements shall be conducted after application of DC working voltage for 30 minutes.						
Resistance to soldering heat	The following specifications shall be satisfied when the capacitors are restored to 20°C after exposing them at 250°C for 30 seconds.						
	Leakage current	Less than specified value					
	Capacitance change	Within $\pm 10\%$ of initial value					
	tan δ	Less than specified value					

Multiplier for Ripple Current vs. Frequency

CAP(μ F) \ Frequency(Hz)	60(50)	120	500	1K	$\geq 10K$
$0.1 \leq CAP \leq 100 \mu F$	0.8	1.0	1.20	1.30	1.50
$100 < CAP \leq 1000 \mu F$	0.8	1.0	1.10	1.15	1.20

Diagram of Dimensions:(unit:mm)

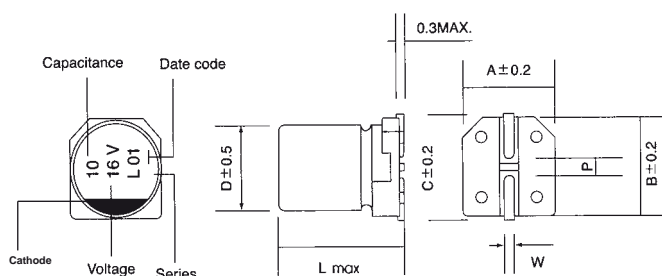

ϕD	L	A	B	C	W	P
4	5.5	4.3	4.3	4.9	0.5~0.8	1.0
5	5.5	5.3	5.3	5.9	0.5~0.8	1.4
6.3	5.5	6.6	6.6	7.2	0.5~0.8	2.2
6.3	7.7	6.6	6.6	7.2	0.5~0.8	2.2
8	6.5	8.3	8.3	9.0	0.5~0.8	2.3
8	10.5	8.3	8.3	9.0	0.7~1.1	3.1
10	10.5	10.3	10.3	11.0	0.7~1.1	4.5

Case Size

φ DxDL(mm)

Cap(μ F)	WV	6.3		10		16		25		35		50	
		Size	Ripple	Size	Ripple	Size	Ripple	Size	Ripple	Size	Ripple	Size	Ripple
0.1												4X5.5	1.0
0.22												4X5.5	2.6
0.33												4X5.5	3.2
0.47												4X5.5	3.8
1.0												4X5.5	6.2
2.2												4X5.5	11
3.3												4X5.5	14
4.7								4X5.5	13	4X5.5	15	5X5.5	19
10						4X5.5	17	4X5.5	23	5X5.5	25	6.3X5.5	30
22		4X5.5	22	5X5.5	28	5X5.5	30	6.3X5.5	40	6.3X5.5	42	6.3X7.7	52
33		5X5.5	32	5X5.5	34	6.3X5.5	44	6.3X5.5	48	6.3X7.7	57	8X10.5	80
47		5X5.5	36	6.3X5.5	48	6.3X5.5	50	6.3X7.7	63	8X10.5	92	8X10.5	95
100		6.3X5.5	60	6.3X7.7	79	6.3X7.7	81	8X10.5	116	10X10.5	150	10X10.5	160
220		6.3X7.7	110	8X10.5	140	10X10.5	216	10X10.5	240	10X10.5	280		
330		8X10.5	160	10X10.5	240	10X10.5	300	10X10.5	375				
470		10X10.5	260	10X10.5	280	10X10.5	320						
1000		10X10.5	340										

Ripple Current (mA, rms) at 105°C 120Hz

NV Series

Features

- ◆ 85°C Non-polarized
- ◆ Reflow soldering is available
- ◆ Available for high density mounting
- ◆ RoHS Compliant



Specifications

Item	Performance Characteristics																					
Operating Temperature Range	-40~ +85°C																					
Rated Voltage Range	6.3~50 VDC																					
Capacitance Range	0.1 to 560 μF																					
Capacitance Tolerance	±20%(120Hz,+20°C)																					
Leakage Current (+20°C,max.)	0.05 CV or 10 (μA) After 2 minutes, whichever is greater measured with rated working voltage applied																					
Dissipation Factor (tan δ , at 20°C , 120Hz)	<table border="1"> <tr> <td>Rated voltage(VDC)</td> <td>6.3</td> <td>10</td> <td>16</td> <td>25</td> <td>35</td> <td>50</td> </tr> <tr> <td>D.F. (%) max.</td> <td>24</td> <td>20</td> <td>17</td> <td>17</td> <td>15</td> <td>15</td> </tr> </table>	Rated voltage(VDC)	6.3	10	16	25	35	50	D.F. (%) max.	24	20	17	17	15	15							
	Rated voltage(VDC)	6.3	10	16	25	35	50															
D.F. (%) max.	24	20	17	17	15	15																
Low Temperature Characteristics (at 120Hz)	Impedance ratio max																					
	<table border="1"> <tr> <td>Rated voltage(VDC)</td> <td>6.3</td> <td>10</td> <td>16</td> <td>25</td> <td>35</td> <td>50</td> </tr> <tr> <td>Z-25°C / Z+20°C</td> <td>4</td> <td>3</td> <td>2</td> <td>2</td> <td>2</td> <td>2</td> </tr> <tr> <td>Z-40°C / Z+20°C</td> <td>8</td> <td>6</td> <td>4</td> <td>3</td> <td>3</td> <td>3</td> </tr> </table>	Rated voltage(VDC)	6.3	10	16	25	35	50	Z-25°C / Z+20°C	4	3	2	2	2	2	Z-40°C / Z+20°C	8	6	4	3	3	3
	Rated voltage(VDC)	6.3	10	16	25	35	50															
Z-25°C / Z+20°C	4	3	2	2	2	2																
Z-40°C / Z+20°C	8	6	4	3	3	3																
Endurance	Test conditions Duration time :2000 Hrs Ambient temperature :+85°C Applied voltage :Rated DC working voltage After test requirement at +20°C: Capacitance change :Within ±25% of the initial value Dissipation factor :Not more than 200% of specified value Leakage current :Not more than the specified value																					
Shelf Life	Test conditions Duration time :1000 Hrs Ambient temperature :+85°C Applied voltage :None After test requirement at +20°C : Same limits as Endurance. Pre-treatment for measurements shall be conducted after application of DC working voltage for 30 minutes.																					
Resistance to soldering heat	The capacitors shall be kept on the hot plate maintained at 250°C for 30 seconds. After removing from the hot plate and restored at room temperature, they meet the characteristic requirements listed under.																					
	<table border="1"> <tr> <td>Leakage current</td> <td>Less than specified value</td> </tr> <tr> <td>Capacitance change</td> <td>Within ±10% of initial value</td> </tr> <tr> <td>tan δ</td> <td>Less than specified value</td> </tr> </table>	Leakage current	Less than specified value	Capacitance change	Within ±10% of initial value	tan δ	Less than specified value															
	Leakage current	Less than specified value																				
Capacitance change	Within ±10% of initial value																					
tan δ	Less than specified value																					

Multiplier for Ripple Current vs. Frequency

Frequency(Hz)	60(50)	120	500	1K	≥10K
Multiplier	0.8	1.0	1.20	1.30	1.50

Diagram of Dimensions:(unit:mm)

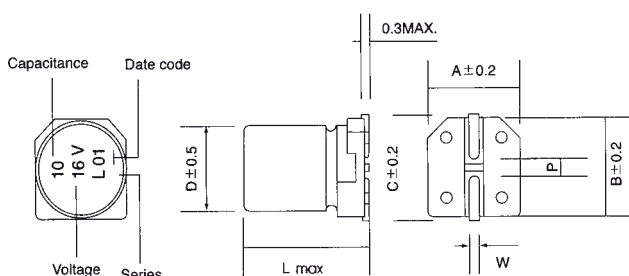

φD	L	A	B	C	W	P
4	5.5	4.3	4.3	4.9	0.5~0.8	1.0
5	5.5	5.3	5.3	5.9	0.5~0.8	1.4
6.3	5.5	6.6	6.6	7.2	0.5~0.8	2.2
6.3	7.7	6.6	6.6	7.2	0.5~0.8	2.2
8	6.5	8.3	8.3	9.0	0.5~0.8	2.3
8	10.5	8.3	8.3	9.0	0.7~1.1	3.1
10	10.5	10.3	10.3	11.0	0.7~1.1	4.5

Case Size

φ DxL(mm)

WV Cap(μF)	6.3		10		16		25		35		50	
	Size	Ripple	Size	Ripple	Size	Ripple	Size	Ripple	Size	Ripple	Size	Ripple
0.1											4X5.5	1.0
0.22											4X5.5	2.0
0.33											4X5.5	2.8
0.47											4X5.5	4.0
1											4X5.5	8.4
2.2									4X5.5	8.4	4X5.5	13
											5X5.5	13
3.3					4X5.5	12	4X5.5	12	4X5.5	16	4X5.5	17
							5X5.5	12	5X5.5		16	5X5.5
4.7					4X5.5	12	4X5.5	16	4X5.5	18	5X5.5	20
							5X5.5	16	5X5.5		18	6.3X5.5
10	4X5.5	15	4X5.5	17	4X5.5	23	5X5.5	27	6.3X5.5	29	6.3X5.5	32
			5X5.5		23		6.3X5.5	27				
22	4X5.5	28	5X5.5	33	5X5.5	37	6.3X5.5	40	6.3X5.5	45	8X10.5	60
	5X5.5	32	6.3X5.5	37	6.3X5.5	37						
33	5X5.5	37	6.3X5.5	41	6.3X5.5	49	6.3X7.7	51	8X10.5	58	10X10.5	75
							8X6.5	55				
47	6.3X5.5	45	6.3X5.5	50	6.3X7.7	51	6.3X7.7	56	8X10.5	64	10X10.5	100
							8X6.5	55				
100	6.3X7.7	65	6.3X7.7	75	8X10.5	100	8X10.5	130				
	8X6.5	70	8X6.5	80								
220	8X10.5	120	8X10.5	150	10X10.5	170						
330	8X10.5	160	10X10.5	180								
470	10X10.5	190										
560	10X10.5	220										

Ripple Current (mA, rms) at 85°C 120Hz

SMD

KV Series

Features

- ◆ 85°C Low leakage current case diameter $\phi 4 \sim \phi 8$
- ◆ Reflow soldering is available
- ◆ Available for high density mounting
- ◆ RoHS Compliant



Specifications

Item	Performance Characteristics						
Operating Temperature Range	-40~ +85°C						
Rated Voltage Range	6.3~50 VDC						
Capacitance Range	0.1 to 330 μ F						
Capacitance Tolerance	$\pm 20\%$ (120Hz,+20°C)						
Leakage Current (+20°C,max.)	$I \leq 0.002 CV$ or $0.4 (\mu A)$ After 2 minutes, whichever is greater measured with rated working voltage applied						
Dissipation Factor ($\tan \delta$ · at 20°C · 120Hz)	Working voltage(VDC)	6.3	10	16	25	35	50
	D.F. (%) max.	26	22	18	16	14	12
Low Temperature Characteristics (at 120Hz)	Impedance ratio max						
	Working voltage(VDC)	6.3	10	16	25	35	50
	Z -25°C / Z +20°C	4	3	2	2	2	2
	Z -40°C / Z +20°C	8	6	4	4	3	3
Endurance	Test conditions						
	Duration time	:1000 Hrs					
	Ambient temperature	:+85°C					
	Applied voltage	:Rated DC working voltage					
	After test requirement at +20°C:						
	Capacitance change	:Within $\pm 25\%$ of the initial value					
Dissipation factor	:Not more than 200% of specified value						
Leakage current	:Not more than the specified value						
Shelf Life	Test conditions						
	Duration time	:1000 Hrs					
	Ambient temperature	:+85°C					
	Applied voltage	:None					
	After test requirement at +20°C : Same limits as Endurance. Pre-treatment for measurements shall be conducted after application of DC working voltage for 30 minutes.						
Resistance to soldering heat	The capacitors shall be kept on the hot plate maintained at 250°C for 30 seconds. After removing from the hot plate and restored at room temperature, they meet the characteristic requirements listed under.						
	Leakage current	Less than specified value					
	Capacitance change	Within $\pm 10\%$ of initial value					
	$\tan \delta$	Less than specified value					

Multiplier for Ripple Current vs. Frequency

CAP(μ F) \ Frequency(Hz)	60(50)	120	500	1K	$\geq 10K$
$0.1 \leq CAP \leq 100 \mu F$	0.8	1	1.2	1.3	1.5
$100 < CAP \leq 330 \mu F$	0.8	1	1.1	1.15	1.2

Diagram of Dimensions:(unit:mm)

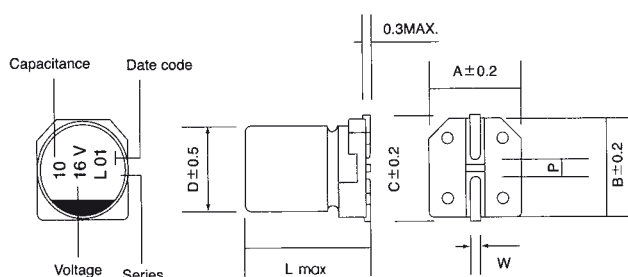

ϕD	L	A	B	C	W	P
4	5.5	4.3	4.3	4.9	0.5~0.8	1.0
5	5.5	5.3	5.3	5.9	0.5~0.8	1.4
6.3	5.5	6.6	6.6	7.2	0.5~0.8	2.2
6.3	7.7	6.6	6.6	7.2	0.5~0.8	2.2
8	6.5	8.3	8.3	9.0	0.5~0.8	2.3
8	10.5	8.3	8.3	9.0	0.7~1.1	3.1
10	10.5	10.3	10.3	11.0	0.7~1.1	4.5

Case Size

φ DxL(mm)

WV Cap(μF)	6.3		10		16		25		35		50	
	Size	Ripple	Size	Ripple	Size	Ripple	Size	Ripple	Size	Ripple	Size	Ripple
0.1											4x5.5	1
0.22											4x5.5	2
0.33											4x5.5	2.8
0.47											4x5.5	4
1											4x5.5	8.4
2.2									4x5.5	8.4	4x5.5	13
3.3							4x5.5	10	4x5.5	15	4x5.5	17
4.7					4x5.5	10	4x5.5	16	4x5.5	18	6.3x5.5	20
10	4x5.5	15	4x5.5	23	4x5.5	23	4x5.5	27	6.3x5.5	29	6.3x5.5	33
22	4x5.5	28	4x5.5	33	5x5.5	37	5x5.5	42	6.3x5.5	46	6.3x7.7	48
33	4x5.5	37	5x5.5	41	6.3x5.5	49	6.3x5.5	52	6.3x7.7	58	6.3x7.7	66
											8x6.5	52
47	4x5.5	45	6.3x5.5	52	6.3x5.5	58	6.3x7.7	65	6.3x7.7	75	8x6.5	71
											8x6.5	62
100	5x5.5	70	6.3x7.7	75	6.3x7.7	85	6.3x7.7	102				
			8x6.5	80	8x6.5	92	8x6.5	110				
220	6.3x7.7	102	6.3x7.7	125								
	8x6.5	110	8x6.5	135								
330	6.3x7.7	155										
	8x6.5	170										

Ripple Current (mA, rms) at 85°C 120Hz

ZV Series

Features

- ◆ Low impedance 100 KHz
- ◆ Reflow soldering is available
- ◆ Available for high density mounting
- ◆ Endurance 2000~5000 hrs at 105°C
- ◆ RoHS Compliant



Specifications

Item	Performance Characteristics																					
Operating Temperature Range	-55~ +105°C																					
Rated Voltage Range	6.3~50 VDC																					
Capacitance Range	1 to 6800 μ F																					
Capacitance Tolerance	$\pm 20\%$ (120Hz, +20°C)																					
Leakage Current (+20°C, max.)	0.01CV or 3(μ A) After 2 minutes, whichever is greater measured with rated working voltage applied																					
Dissipation Factor ($\tan \delta$ · at 20°C · 120Hz)	<table border="1"> <tr> <td>Working voltage(VDC)</td> <td>6.3</td> <td>10</td> <td>16</td> <td>25</td> <td>35</td> <td>50</td> </tr> <tr> <td>D.F. (%) max.</td> <td>26</td> <td>19</td> <td>16</td> <td>14</td> <td>14</td> <td>12</td> </tr> </table>	Working voltage(VDC)	6.3	10	16	25	35	50	D.F. (%) max.	26	19	16	14	14	12							
	Working voltage(VDC)	6.3	10	16	25	35	50															
D.F. (%) max.	26	19	16	14	14	12																
For capacitance value > 1000 μ F, add 2 per another 1000 μ F.																						
Low Temperature Characteristics (at 120Hz)	Impedance ratio max																					
	<table border="1"> <tr> <td>Working voltage(VDC)</td> <td>6.3</td> <td>10</td> <td>16</td> <td>25</td> <td>35</td> <td>50</td> </tr> <tr> <td>Z-25°C / Z+20°C</td> <td>2</td> <td>3</td> <td>2</td> <td>2</td> <td>2</td> <td>2</td> </tr> <tr> <td>Z-55°C / Z+20°C</td> <td>8</td> <td>6</td> <td>4</td> <td>4</td> <td>3</td> <td>3</td> </tr> </table>	Working voltage(VDC)	6.3	10	16	25	35	50	Z-25°C / Z+20°C	2	3	2	2	2	2	Z-55°C / Z+20°C	8	6	4	4	3	3
	Working voltage(VDC)	6.3	10	16	25	35	50															
Z-25°C / Z+20°C	2	3	2	2	2	2																
Z-55°C / Z+20°C	8	6	4	4	3	3																
Endurance	Test conditions Duration time :2000 Hrs (ϕ 12.5~16:5000H) Ambient temperature :+105°C Applied voltage :Rated DC working voltage After test requirement at +105°C : Capacitance change : $\leq \pm 25\%$ of the initial measured value Dissipation factor : $\leq 200\%$ of the initial specified value Leakage current : \leq The initial specified value																					
Shelf Life	Test conditions Duration time :1000 Hrs Ambient temperature :+105°C Applied voltage :None After test requirement at +20°C : Same limits as Endurance. Pre-treatment for measurements shall be conducted after application of DC working voltage for 30 minutes.																					
Resistance to soldering heat	The capacitors shall be kept on the hot plate maintained at 250°C for 30 seconds. After removing from the hot plate and restored at room temperature, they meet the characteristic requirements listed under.																					
	<table border="1"> <tr> <td>Leakage current</td> <td>Less than specified value</td> </tr> <tr> <td>Capacitance change</td> <td>Within $\pm 10\%$ of initial value</td> </tr> <tr> <td>$\tan \delta$</td> <td>Less than specified value</td> </tr> </table>	Leakage current	Less than specified value	Capacitance change	Within $\pm 10\%$ of initial value	$\tan \delta$	Less than specified value															
	Leakage current	Less than specified value																				
Capacitance change	Within $\pm 10\%$ of initial value																					
$\tan \delta$	Less than specified value																					

Multiplier for Ripple Current vs. Frequency

CAP(μ F) \ Frequency(Hz)	60(50)	120	400	1K	10K	50K-100K
CAP \leq 10	0.47	0.59	0.76	0.85	0.97	1.0
10 < CAP	0.52	0.65	0.80	0.89	0.97	1.0

Diagram of Dimensions:(unit:mm)

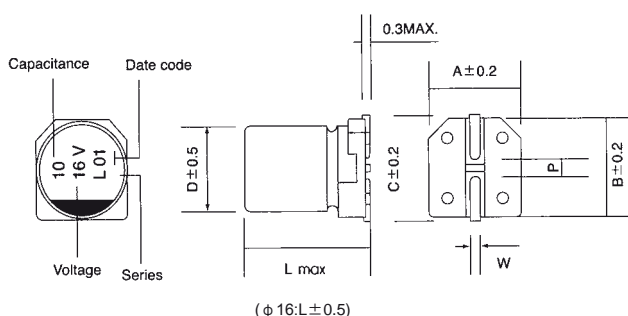

ϕ D	L	A	B	C	W	P
4	5.5	4.3	4.3	4.9	0.5~0.8	1.0
5	5.5	5.3	5.3	5.9	0.5~0.8	1.4
6.3	5.5	6.6	6.6	7.2	0.5~0.8	2.2
6.3	7.7	6.6	6.6	7.2	0.5~0.8	2.2
8	6.5	8.3	8.3	9.0	0.5~0.8	2.3
8	10.5	8.3	8.3	9.0	0.7~1.1	3.1
10	10.5	10.3	10.3	11.0	0.7~1.1	4.5
12.5	14	13.5	13.5	15.0	1.0~1.4	5.5
16	17	17.1	17.1	18.0	1.0~1.4	6.3

Case Size

φ DxL(mm)

WV(V) Cap(μF)	6.3			10			16			25			35			50		
	Size	Ripple	imp.	Size	Ripple	imp.	Size	Ripple	imp.	Size	Ripple	imp.	Size	Ripple	imp.	Size	Ripple	imp.
2.2													4x5.5	53	5	4x5.5	53	5
3.3													4x5.5	53	5	4x5.5	53	5
4.7										4x5.5	53	5	4x5.5	53	5	4x5.5	53	5
6.8										4x5.5	58	4.5	4x5.5 5x5.5	65 85	4.0 2.8	5x5.5	65	4
10							4x5.5	65	5	4x5.5 5x5.5	74 80	3.7 2.6	4x5.5 5x5.5 6.3x5.5	90 98 110	3.5 2.5 2.4	5x5.5 6.3x5.5	90 100	3.5 2.5
15							4x5.5	70	4.6	5x5.5 6.3x5.5	100 115	2.2 1.8	5x5.5 6.3x5.5	120 140	1.8 1.5	6.3x5.5	130	1.8
22	4x5.5	53	3.5	4x5.5	80	2.6	4x5.5 5x5.5	83 110	3.0 2.6	5x5.5 6.3x5.5	128 140	1.7 1.5	5x5.5 6.3x5.5	140 150	1.4 1.3	6.3x5.5	140	1.5
27	4x5.5	65	3.2	5x5.5	85	2.4	5x5.5	135	1.9	6.3x5.5	145	1.4	6.3x5.5	165	1.2	6.3x7.7	160	1.35
33	4x5.5 5x5.5	80 82	2.8 2.6	4x5.5 5x5.5	85 110	2.3 2.1	5x5.5 6.3x5.5	160 170	2.2 1.5	5x5.5 6.3x5.5	145 175	1.4 1.3	6.3x5.5 6.3x7.7 8x6.5	185 210 230	1.2 0.9 0.8	6.3x7.7 8x6.5	170 180	0.8 0.75
47	4x5.5 5x5.5	82 85	2.4 2.2	5x5.5 6.3x5.5	130 160	2.0 1.5	5x5.5 6.3x5.5	170 185	2.0 1.5	6.3x5.5 6.3x7.7 8x6.5	180 195 220	1.2 0.8 0.75	6.3x5.5 6.3x7.7 8x6.5	200 220 240	1.0 0.75 0.7	6.3x7.7 8x6.5	200 220	0.79 0.72
56	5x5.5	94	1.70	6.3x5.5	180	1.45	6.3x5.5	195	1.3	6.3x5.5	195	1.15	6.3x7.7	230	0.73	8x10.5	260	0.68
68	5x5.5 6.3x5.5	100 120	1.6 1.3	6.3x5.5 6.3x7.7	195 210	1.4 1.3	6.3x5.5 6.3x7.7 8x6.5	205 210 220	1.2 1.1 1.0	6.3x5.5 6.3x7.7 8x6.5	200 210 230	1.1 0.75 0.7	6.3x7.7 8x6.5	240 250	0.7 0.68	8x10.5	300	0.6
100	5x5.5 6.3x5.5	110 160	1.5 1.1	6.3x5.5 6.3x7.7	210 230	1.3 1.2	6.3x5.5 6.3x7.7	210 220	1.1 0.9	6.3x7.7 8x6.5	220 250	0.75 0.7	6.3x7.7 8x10.5	270 350	0.67 0.5	8x10.5	310	0.55
150	6.3x5.5 6.3x7.7	170 195	0.95 0.85	6.3x5.5 8x6.5	220 240	1.0 0.8	6.3x7.7 8x6.5	225 240	0.8 0.7	8x10.5	420	0.5	8x10.5	430	0.45	10x10.5	540	0.28
220	6.3x5.5 6.3x7.7	195 210	0.6 0.57	6.3x7.7 8x6.5	245 255	0.60 0.55	6.3x7.7 8x6.5	250 260	0.75 0.66	8x10.5 10x10.5	480 500	0.3 0.28	8x10.5	450	0.25	10x10.5	570	0.26
330	6.3x7.7 8x6.5	230 250	0.51 0.49	8x10.5	400	0.36	8x10.5	470	0.34	8x10.5	510	0.26	10x10.5	570	0.23	12.5x14	620	0.25
470	8x10.5	380	0.45	8x10.5	470	0.32	8x10.5	520	0.3	10x10.5	570	0.18	12.5x14	900	0.15			
680	8x10.5	420	0.42	10x10.5	620	0.29	10x10.5	600	0.26				12.5x14	900	0.15			
1000	8x10.5 10x10.5	470 500	0.28 0.25	10x10.5	670	0.25				12.5x14	900	0.15				16x17	820	0.2
1200	10x10.5	530	0.20				12.5x14	900	0.15									
1500	10x10.5	570	0.17				12.5x14	900	0.15				16x17	1030	0.11			
2200				12.5x14	900	0.15				16x17	1030	0.11						
3300	12.5x14	900	0.15				16x17	1030	0.11									
4700				16x17	1030	0.11												
6800	16x17	1030	0.11															

Ripple current (mArms) at 105°C 100KHz
Max Impedance at 20°C 100KHz

SMD

DV Series Chip type

Features

- ◆ Chip type ,Low impedance
- ◆ Chip type with Endurance of 2000~5000 hours at +105°C
- ◆ Designed for surface mounting on high density PC board
- ◆ Applicable to automatic mounting machine using carrier tape
- ◆ Complied to the RoHS directive

ZV **Low Impedance** → DV



Specifications

Item	Performance Characteristics																					
Operating Temperature Range	-55~ +105°C																					
Rated Voltage Range	6.3~50 VDC																					
Capacitance Range	1 to 6800 μ F																					
Capacitance Tolerance	±20%(120Hz,+20°C)																					
Leakage Current (+20°C,max.)	$I \leq 0.01 CV$ or $3 (\mu A)$ After 2 minutes whichever is greater measured with rated working voltage applied.																					
Dissipation Factor ($\tan \delta$, at 20°C , 120Hz)	<table border="1"> <tr> <td>Working voltage(VDC)</td> <td>6.3</td> <td>10</td> <td>16</td> <td>25</td> <td>35</td> <td>50</td> </tr> <tr> <td>D.F. (%) max.</td> <td>24</td> <td>19</td> <td>16</td> <td>14</td> <td>14</td> <td>12</td> </tr> </table>	Working voltage(VDC)	6.3	10	16	25	35	50	D.F. (%) max.	24	19	16	14	14	12							
	Working voltage(VDC)	6.3	10	16	25	35	50															
D.F. (%) max.	24	19	16	14	14	12																
For capacitance value > 1000 μ F, add 2 per another 1000 μ F.																						
Low Temperature Characteristics (at 120Hz)	Impedance ratio max																					
	<table border="1"> <tr> <td>Working voltage(VDC)</td> <td>6.3</td> <td>10</td> <td>16</td> <td>25</td> <td>35</td> <td>50</td> </tr> <tr> <td>Z-25°C / Z+20°C</td> <td>2</td> <td>2</td> <td>2</td> <td>2</td> <td>2</td> <td>2</td> </tr> <tr> <td>Z-55°C / Z+20°C</td> <td>8</td> <td>6</td> <td>4</td> <td>4</td> <td>3</td> <td>3</td> </tr> </table>	Working voltage(VDC)	6.3	10	16	25	35	50	Z-25°C / Z+20°C	2	2	2	2	2	2	Z-55°C / Z+20°C	8	6	4	4	3	3
	Working voltage(VDC)	6.3	10	16	25	35	50															
Z-25°C / Z+20°C	2	2	2	2	2	2																
Z-55°C / Z+20°C	8	6	4	4	3	3																
Endurance	Test conditions Duration time :2000 Hrs (φ 12.5~16:5000H) Ambient temperature :+105°C Applied voltage :Rated DC working voltage After test requirement at +20°C : Capacitance change :Within ±30% of initial value Dissipation factor :Less than 300% of specified value Leakage current :Less than specified value																					
Shelf Life	Test conditions Duration time :1000 Hrs Ambient temperature :+105°C Applied voltage :None After test requirement at +20°C : Same limits as Endurance. Pre-treatment for measurements shall be conducted after application of DC working voltage for 30 minutes.																					
Resistance to soldering heat	The following specifications shall be satisfied when the capacitors are restored to 20°C after exposing them at 250°C for 30 seconds.																					
	<table border="1"> <tr> <td>Leakage current</td> <td>Less than specified value</td> </tr> <tr> <td>Capacitance change</td> <td>Within ±10% of initial value</td> </tr> <tr> <td>$\tan \delta$</td> <td>Less than specified value</td> </tr> </table>	Leakage current	Less than specified value	Capacitance change	Within ±10% of initial value	$\tan \delta$	Less than specified value															
	Leakage current	Less than specified value																				
Capacitance change	Within ±10% of initial value																					
$\tan \delta$	Less than specified value																					

Multiplier for Ripple Current vs. Frequency

CAP(μ F)\Frequency(Hz)	60(50)	120	400	1K	10K	50K-100K
CAP ≤ 10	0.47	0.59	0.76	0.85	0.97	1.0
10 < CAP	0.52	0.65	0.80	0.89	0.97	1.0

Diagram of Dimensions:(unit:mm)

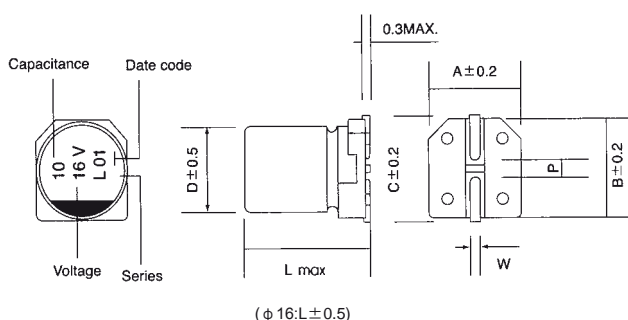

φ D	L	A	B	C	W	P
4	5.5	4.3	4.3	4.9	0.5~0.8	1.0
5	5.5	5.3	5.3	5.9	0.5~0.8	1.4
6.3	5.5	6.6	6.6	7.2	0.5~0.8	2.2
6.3	7.7	6.6	6.6	7.2	0.5~0.8	2.2
8	6.5	8.3	8.3	9.0	0.5~0.8	2.3
8	10.5	8.3	8.3	9.0	0.7~1.1	3.1
10	10.5	10.3	10.3	11.0	0.7~1.1	4.5
12.5	14	13.5	13.5	15.0	1.0~1.4	5.5
16	17	17.1	17.1	18.0	1.0~1.4	6.3

Case Size

φ DxL(mm)

WV(V) Cap(μF)	6.3			10			16			25			35			50		
	Size	Ripple	imp.	Size	Ripple	imp.	Size	Ripple	imp.	Size	Ripple	imp.	Size	Ripple	imp.	Size	Ripple	imp.
1.0																4X5.5	55	4.5
2.2																4X5.5	55	4.5
3.3													4X5.5	80	2.8	4X5.5	55	4.5
4.7													4X5.5	85	2.5	4X5.5	55	4.5
6.8										4X5.5	70	2.8	4X5.5	88	2.2	5X5.5	75	3.8
10							4X5.5	80	2.2	4X5.5	85	2.1	4X5.5	90	2.0	5X5.5	95	2.8
15							4X5.5	85	2.0	5X5.5	125	1.9	5X5.5	125	1.4	6.3X5.5	130	2.2
22	4X5.5	75	2.2	4X5.5	80	2.2	4X5.5	90	1.98	5X5.5	145	1.2	5X5.5	155	1.1	6.3X5.5	150	1.3
27	4X5.5	79	1.98	5X5.5	125	1.9	5X5.5	140	1.2	6.3X5.5	160	1.15	6.3X5.5	170	1.05	6.3X5.5	170	1.05
33	4X5.5	82	1.9	4X5.5	90	1.85	5X5.5	170	0.74	6.3X5.5	200	0.62	6.3X5.5	210	0.6	6.3X7.7	180	1.2
47	5X5.5	130	1.3	5X5.5	150	1.2	6.3X5.5	185	0.6	5X5.5	160	1.05	6.3X5.5	230	0.54	6.3X7.7	190	0.71
	4X5.5	86	1.88	5X5.5	165	1.1	5X5.5	195	1.05	6.3X5.5	220	0.56	6.3X5.5	240	0.53	6.3X7.7	230	0.7
56	5X5.5	150	1.1	6.3X5.5	180	0.59	6.3X5.5	210	0.58	6.3X7.7	230	0.54	8X6.5	250	0.49	8X6.5	240	0.69
	5X5.5	150	1.10	6.3X5.5	210	0.57	6.3X5.5	220	0.56	6.3X5.5	230	0.54	6.3X7.7	250	0.49	8X10.5	300	0.52
68	5X5.5	160	0.9	6.3X5.5	220	0.55	6.3X5.5	230	0.54	6.3X5.5	240	0.48	6.3X7.7	265	0.4	8X10.5	320	0.5
	6.3X5.5	220	0.55	6.3X5.5	220	0.55	8X6.5	240	0.50	8X6.5	260	0.45	8X6.5	260	0.45	8X10.5	320	0.5
100	5X5.5	170	0.8	6.3X5.5	240	0.53	6.3X5.5	255	0.52	6.3X7.7	290	0.38	6.3X7.7	300	0.38	8X10.5	350	0.46
	6.3X5.5	230	0.53	6.3X5.5	240	0.53	6.3X5.5	255	0.52	8X6.5	300	0.36	8X10.5	420	0.28	8X10.5	350	0.46
150	6.3X5.5	235	0.51	6.3X5.5	250	0.49	6.3X7.7	265	0.45	8X10.5	480	0.25	8X10.5	510	0.24	10X10.5	600	0.25
	8X6.5	250	0.48	8X6.5	260	0.47	8X6.5	270	0.44	8X6.5	270	0.44	8X10.5	480	0.25	8X10.5	510	0.24
220	6.3X5.5	240	0.48	6.3X7.7	270	0.44	6.3X7.7	275	0.43	8X10.5	530	0.22	8X10.5	570	0.21	10X10.5	650	0.23
	6.3X7.7	260	0.45	8X6.5	285	0.40	8X6.5	285	0.41	8X10.5	530	0.22	8X10.5	570	0.21	10X10.5	650	0.23
330	6.3X7.7	275	0.36	8X10.5	500	0.25	8X10.5	550	0.25	8X10.5	570	0.2	10X10.5	650	0.15	12.5X14	800	0.21
	8X6.5	290	0.34	8X10.5	500	0.25	8X10.5	550	0.25	8X10.5	570	0.2	10X10.5	650	0.15	12.5X14	800	0.21
470	8X10.5	450	0.28	8X10.5	550	0.25	8X10.5	590	0.22	10X10.5	650	0.15	12.5X14	1100	0.08			
680	8X10.5	500	0.25	10X10.5	680	0.2	10X10.5	720	0.16				12.5X14	1100	0.08			
1000	8X10.5	530	0.20	10X10.5	740	0.15				12.5X14	1100	0.08				16X17	1000	0.078
1200	10X10.5	600	0.16															
1500	10X10.5	650	0.13				12.5X14	1100	0.08				16X17	1250	0.052			
2200				12.5X14	1100	0.08				16X17	1250	0.052						
3300	12.5X14	1100	0.08				16X17	1250	0.052									
4700				16X17	1250	0.052												
6800	16X17	1250	0.052															

Ripple current (mA_{rms}) at 105°C 100KHz

Max Impedance at 20°C 100KHz

SMD

RV Series Chip type

Features

- ◆ Chip type ,Low impedance
- ◆ Chip type with Endurance of 5000 hours at +105°C
- ◆ Designed for surface mounting on high density PC board
- ◆ Applicable to automatic mounting machine using carrier tape
- ◆ Complied to the RoHS directive

DV Low Impedance Long Life **RV**



Specifications

Item	Performance Characteristics																					
Operating Temperature Range	-55 to +105°C																					
Rated Voltage Range	6.3 to 50 VDC																					
Capacitance Range	1.0 to 6800μF																					
Capacitance Tolerance	±20%(120Hz,+20°C)																					
Leakage Current (+20°C,max.)	I ≤ 0.01 CV or 3 (μA)After 2 minutes whichever is greater measured with rated working voltage applied.																					
Dissipation Factor (tan δ)	<table border="1"> <tr> <td>Working voltage(VDC)</td> <td>6.3</td> <td>10</td> <td>16</td> <td>25</td> <td>35</td> <td>50</td> </tr> <tr> <td>D.F. (%) max.</td> <td>22</td> <td>19</td> <td>16</td> <td>14</td> <td>14</td> <td>12</td> </tr> </table>	Working voltage(VDC)	6.3	10	16	25	35	50	D.F. (%) max.	22	19	16	14	14	12							
	Working voltage(VDC)	6.3	10	16	25	35	50															
D.F. (%) max.	22	19	16	14	14	12																
For capacitance value > 1000 μ F, add 2 per another 1000 μ F.																						
Low Temperature Characteristics (Impedance ratio at 120hz)	Impedance ratio max																					
	<table border="1"> <tr> <td>Working voltage(VDC)</td> <td>6.3</td> <td>10</td> <td>16</td> <td>25</td> <td>35</td> <td>50</td> </tr> <tr> <td>Z-25°C / Z+20°C</td> <td>4</td> <td>3</td> <td>2</td> <td>2</td> <td>2</td> <td>2</td> </tr> <tr> <td>Z-55°C / Z+20°C</td> <td>8</td> <td>6</td> <td>4</td> <td>4</td> <td>3</td> <td>3</td> </tr> </table>	Working voltage(VDC)	6.3	10	16	25	35	50	Z-25°C / Z+20°C	4	3	2	2	2	2	Z-55°C / Z+20°C	8	6	4	4	3	3
	Working voltage(VDC)	6.3	10	16	25	35	50															
Z-25°C / Z+20°C	4	3	2	2	2	2																
Z-55°C / Z+20°C	8	6	4	4	3	3																
Endurance	Test condition Duration time : 5000hours (2000 hours for φ D ≤ 6.3) Ambient temperature : +105°C Applied voltage : Rated DC working voltage After test requirement at +20°C Capacitance change : Within ±30% of initial value Dissipation factor : Less than 300% of specified value Leakage curren : Less than specified value																					
Shelf Life	Test condition Duration time : 1000Hrs Ambient temperature : +105°C Applied voltage : None After test requirement at +20°C: Same limits as Endurance. Pre-treatment for measurements shall be conducted after application of DC working voltage for 30 minutes.																					
Resistance to soldering heat	The following specifications shall be satisfied when the capacitors are restored to 20°C after exposing them at 250°C for 30 seconds.																					
	<table border="1"> <tr> <td>Leakage current</td> <td>Less than specified value</td> </tr> <tr> <td>Capacitance change</td> <td>Within ± 10% of initial value</td> </tr> <tr> <td>tan δ</td> <td>Less than specified value</td> </tr> </table>	Leakage current	Less than specified value	Capacitance change	Within ± 10% of initial value	tan δ	Less than specified value															
	Leakage current	Less than specified value																				
Capacitance change	Within ± 10% of initial value																					
tan δ	Less than specified value																					

Multiplier for Ripple Current vs. Frequency

CAP(μ F) \ Frequency(Hz)	60(50)	120	400	1K	10K	50K-100K
CAP ≤ 10	0.47	0.59	0.76	0.85	0.97	1.0
10 < CAP	0.52	0.65	0.80	0.89	0.97	1.0

Diagram of Dimensions:(unit:mm)

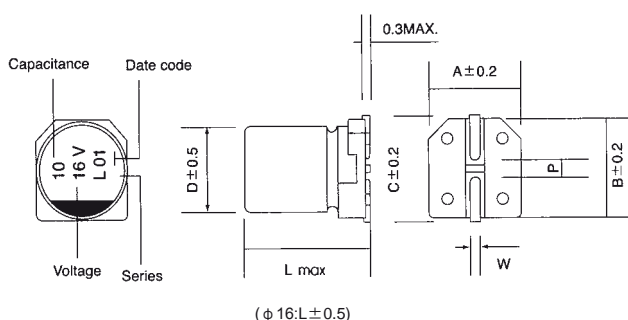

φ D	L	A	B	C	W	P
4	5.5	4.3	4.3	4.9	0.5~0.8	1.0
5	5.5	5.3	5.3	5.9	0.5~0.8	1.4
6.3	5.5	6.6	6.6	7.2	0.5~0.8	2.2
6.3	7.7	6.6	6.6	7.2	0.5~0.8	2.2
8	6.5	8.3	8.3	9.0	0.5~0.8	2.3
8	10.5	8.3	8.3	9.0	0.7~1.1	3.1
10	10.5	10.3	10.3	11.0	0.7~1.1	4.5
12.5	14	13.5	13.5	15.0	1.0~1.4	5.5
16	17	17.1	17.1	18.0	1.0~1.4	6.3

Case Size

φ DxL(mm)

WV(V) Cap(μF)	6.3			10			16			25			35			50		
	Size	Ripple	imp.	Size	Ripple	imp.	Size	Ripple	imp.	Size	Ripple	imp.	Size	Ripple	imp.	Size	Ripple	imp.
1.0																4X5.5	60	2.9
2.2																4X5.5	60	2.9
3.3																4X5.5	60	2.9
4.7													4X5.5	90	1.9	5X5.5	85	1.52
10							4X5.5	90	1.35	4X5.5	90	1.35	5X5.5	150	0.8	6.3X5.5	165	1.4
22	4X5.5	80	1.35	4X5.5	90	1.35	5X5.5	150	0.8	5X5.5	150	0.8	6.3X5.5	230	0.44	6.3X5.5	165	1.2
33	4X5.5	85	1.35	5X5.5	160	0.8	6.3X5.5	230	0.44	6.3X5.5	230	0.44	6.3X5.5	230	0.44	6.3X7.7	185	0.68
47	5X5.5	160	0.8	6.3X5.5	230	0.44	6.3X5.5	230	0.44	6.3X5.5	230	0.44	6.3X5.5	240	0.44	6.3X7.7	185	0.68
68																8X10.5	300	0.34
100	6.3X5.5	240	0.44	6.3X5.5	240	0.44	6.3X5.5	255	0.44	6.3X7.7	300	0.36	8X10.5	450	0.17	8X10.5	350	0.34
150	6.3X5.5	240	0.44	6.3X5.5	250	0.44	6.3X7.7	280	0.36	8X10.5	500	0.17	8X10.5	550	0.17	10X10.5	555	0.25
220	6.3X7.7	280	0.36	6.3X7.7	280	0.36	6.3X7.7	280	0.36	8X10.5	550	0.17	10X10.5	670	0.09	10X10.5	600	0.23
330	8X10.5	450	0.17	8X10.5	500	0.17	8X10.5	550	0.17	8X10.5	600	0.17						
470	8X10.5	500	0.17	8X10.5	550	0.17	8X10.5	600	0.17	10X10.5	670	0.09	12.5X14	1150	0.066	16X17	1610	0.073
680	8X10.5	550	0.17	10X10.5	690	0.09	10X10.5	750	0.09				12.5X14	1150	0.066	16X17	1610	0.073
1000	8X10.5	550	0.17	10X10.5	690	0.09				12.5X14	1150	0.066	16X17	1800	0.035	16X17	1610	0.073
1500	10X10.5	690	0.09				12.5X14	1150	0.066				16X17	1800	0.035			
2200				12.5X14	1150	0.066				16X17	1800	0.035						
3300	12.5X14	1150	0.066				16X17	1800	0.035									
4700				16X17	1800	0.035												
5600																		
6800	16X17	1800	0.035															

Ripple Current(mA rms) at 105°C /100KHz

Max.Impedance(Ω) at 20°C /100KHz

SMD

TV Series High Temperature 125°C

Features

- ◆ Chip type ,operating temperature range-40 to +125°C
- ◆ Designed for surface mounting on high density PC board
- ◆ Applicable to automatic insertion machine using carrier tape
- ◆ RoHS Compliant



Specifications

Item	Performance Characteristics
Operating Temperature Range	-40~+125°C
Rated Voltage Range	10~50 VDC
Capacitance Range	10 to 330 μ F
Capacitance Tolerance	±20%(120Hz,+20°C)
Leakage Current (+20°C,max.)	I ≤0.03 CV or 4 (μ A)After 1 minutes whichever is greater measured with rated working voltage applied.
Dissipation Factor (tan δ , at 20°C , 120Hz)	Working Voltage(VDC) 10 16 25 35 50
	D.F.(%)max. 32 24 21 18 18
Low Temperature Characteristics (at 120Hz)	Impedance ratio max
	Working voltage(VDC) 10 16 25 35 50 Z-25°C / Z+20°C 12 8 6 4 4
Endurance	Test condition Duration time : 1000 Hrs (Φ8X6.5mm & 6.3X7.7mm) ; 2000Hrs (Φ8X10.5mm & 10X10.5mm) Ambient temperature :+125°C Applied voltage :Rated DC working voltage After test requirement at +20°C Capacitance change : Within ±30% of initial value Dissipation factor : Less than 300% of specified value Leakage current : Less than specified value
Shelf Life	Test condition Duration time :1000 Hrs Ambient temperature :+125°C Applied voltage :None After test requirement at +20°C :Same limits as Endurance. Pre-treatment for measurements shall be conducted after application of DC working voltage for 30 minutes.
Resistance to soldering heat	The following specifications shall be satisfied when the capacitors are restored to20°C after exposing them at 250°C for 30 seconds. Leakage current Less than specified value Capacitance change Within ±10% of initial value tan δ Less than specified value

Multiplier for Ripple Current vs. Frequency

CAP(μ F)\Frequency(Hz)	60(50)	120	500	1K	≥10K
0.1~47 μ F	0.8	1.0	1.20	1.30	1.50
100~1000 μ F	0.8	1.0	1.10	1.15	1.20

Diagram of Dimensions:(unit:mm)

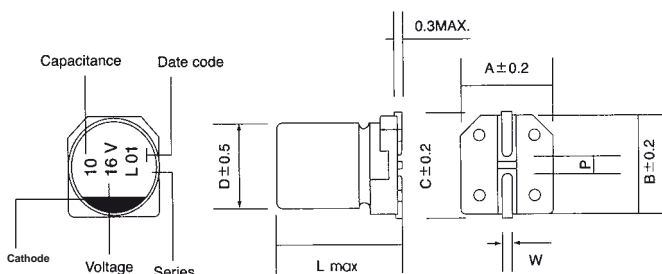

φD	L	A	B	C	W	P
6.3	7.7	6.6	6.6	7.2	0.5~0.8	2.2
8	6.5	8.3	8.3	9.0	0.5~0.8	2.3
8	10.5	8.3	8.3	9.0	0.7~1.1	3.1
10	10.5	10.3	10.3	11.0	0.7~1.1	4.5

Case Size

φ DxL(mm)

WV Cap(μ F)	10		16		25		35		50	
	Size	Ripple	Size	Ripple	Size	Ripple	Size	Ripple	Size	Ripple
10									6.3X7.7	22
									8X6.5	24
22									6.3X7.7	35
									8X6.5	38
33							6.3X7.7	40		
							8X6.5	44	8X10.5	46
47					6.3X7.7	45				
					8X6.5	48	8X10.5	52	10X10.5	58
100	6.3X7.7	53								
	8X6.5	58	8X10.5	66	8X10.5	74	10X10.5	80		
220	8X10.5	90	10X10.5	102	10X10.5	116				
330	10X10.5	112								

Ripple Current (mA, rms) at 125°C 120Hz

SMD

SS Series 5 mm 85°C

Features

- ◆ Design for space-saving and high density insertion.
- ◆ 4WV products are standardized for recent battery power source devices.
- ◆ Low price compared to Tantalum capacitors.
- ◆ Applications: VTR, car radio and commercial applications.
- ◆ RoHS Compliant

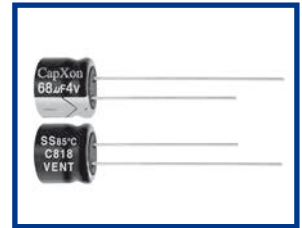

Specifications

Item	Performance Characteristics																								
Operating Temperature Range	-40 to +85°C																								
Rated Voltage Range	4 to 50 VDC																								
Capacitance Range	0.1 to 330 µ F																								
Capacitance Tolerance	± 20% (120Hz, +20°C)																								
Leakage Current(+20°C, max)	I ≤ 0.01 CV or 3 (µ A) After 1 minute, whichever is greater measured with rated working voltage applied.																								
Dissipation Factor (tan δ , at 20°C , 120Hz)	<table border="1"> <tr> <td>Working Voltage (VDC)</td> <td>4</td> <td>6.3</td> <td>10</td> <td>16</td> <td>25</td> <td>35</td> <td>50</td> </tr> <tr> <td>D.F. (%)max</td> <td>35</td> <td>24</td> <td>20</td> <td>16</td> <td>14</td> <td>12</td> <td>10</td> </tr> </table>	Working Voltage (VDC)	4	6.3	10	16	25	35	50	D.F. (%)max	35	24	20	16	14	12	10								
Working Voltage (VDC)	4	6.3	10	16	25	35	50																		
D.F. (%)max	35	24	20	16	14	12	10																		
Low Temperature Characteristics (at 120Hz)	Impedance ratio max <table border="1"> <tr> <td>Rated voltage(VDC)</td> <td>4</td> <td>6.3</td> <td>10</td> <td>16</td> <td>25</td> <td>35</td> <td>50</td> </tr> <tr> <td>Z-25°C / Z+20°C</td> <td>7</td> <td>4</td> <td>3</td> <td>2</td> <td>2</td> <td>2</td> <td>2</td> </tr> <tr> <td>Z-40°C / Z+20°C</td> <td>15</td> <td>8</td> <td>8</td> <td>4</td> <td>4</td> <td>3</td> <td>3</td> </tr> </table>	Rated voltage(VDC)	4	6.3	10	16	25	35	50	Z-25°C / Z+20°C	7	4	3	2	2	2	2	Z-40°C / Z+20°C	15	8	8	4	4	3	3
Rated voltage(VDC)	4	6.3	10	16	25	35	50																		
Z-25°C / Z+20°C	7	4	3	2	2	2	2																		
Z-40°C / Z+20°C	15	8	8	4	4	3	3																		
Endurance	Test conditions Duration time :1000 Hrs Ambient temperature :+85°C Applied voltage :Rated DC working voltage After test requirement at +20°C Capacitance change :≤ ±20% of the initial measured value (4V : ≤ ±30%) Dissipation factor :≤ 200% of the initial specified value Leakage current :≤ The initial specified value																								
Shelf Life	Test conditions Duration time :1000 Hrs Ambient temperature :+85°C Applied voltage :None After test requirement at +20°C : Same limits as Endurance. Pre-treatment for measurements shall be conducted after application of DC working voltage for 30 minutes.																								

Multiplier for Ripple Current vs. Frequency

CAP(µ F)\Frequency(Hz)	60(50)	120	1K	≥10K
0.1~68 µ F	0.8	1	1.30	1.50
100~330 µ F	0.8	1	1.15	1.20

Diagram of Dimensions:(unit:mm)

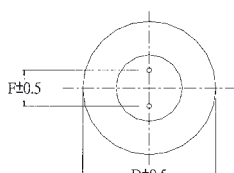
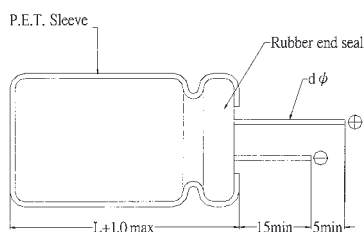

D φ	4	5	6.3	8
F	1.5±0.5	2.0±0.5	2.5±0.5	3.5±0.5
d φ	0.45			

Case Size

φ DxD(mm)

WV Cap(μF)	4		6.3		10		16		25		35		50		
	Size	Ripple	Size	Ripple	Size	Ripple	Size	Ripple	Size	Ripple	Size	Ripple	Size	Ripple	
0.1													4x5	1.5	
0.15													4x5	2.0	
0.22													4x5	2.6	
0.33													4x5	3.2	
0.47													4x5	3.8	
0.68													4x5	5.0	
1													4x5	6.2	
1.5													4x5	7.0	
2.2											4x5	8.4	4x5	9.0	
3.3										4x5	10	4x5	11	4x5	14
4.7							4x5	11	4x5	15	4x5	18	5x5	20	
6.8					4x5	11	4x5	13	4x5	17	5x5	20	6.3x5	25	
10									4x5	27	5x5	29	6.3x5	30	
	4x5	11	4x5	14	4x5	17	4x5	20	5x5	28					
15	4x5	17	4x5	17	4x5	21	5x5	26	5x5	30	6.3x5	33	6.3x5	37	
									6.3x5	33					
22					4x5	30	4x5	33	6.3x5	44	6.3x5	46	6.3x5	48	
	4x5	21	4x5	24	5x5	33	5x5	35					8x5	52	
33			4x5	33	5x5	39	5x5	42	6.3x5	52	8x5	63	8x5	70	
	4x5	28	5x5	37			6.3x5	46							
47	4x5	33	5x5	39	5x5	42	6.3x5	58	6.3x5	62	8x5	83			
					6.3x5	46									
68	5x5	43	6.3x5	53	6.3x5	56	6.3x5	65	8x5	90					
	6.3x5	48													
100	5x5	52	6.3x5	65	6.3x5	76	6.3x5	86	8x5	108					
							8x5	92							
220	6.3x5	78	6.3x5	90	8x5	138									
			8x5	115											
330	8x5	142	8x5	145											

Ripple Current (mA, rms) at 85°C 120Hz

ST Series 5 mm 105°C

Features

- ◆ 5.0+1 mm max height
- ◆ Endurance 105°C, 1000 hrs assured
- ◆ RoHS Compliant

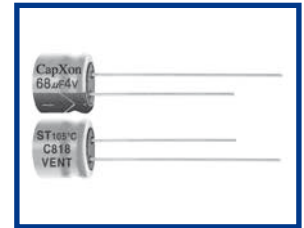

Specifications

Item	Performance Characteristics							
Operating Temperature Range	-40 to +105°C							
Rated Voltage Range	4 to 50 VDC							
Capacitance Range	0.1 to 100 µF							
Capacitance Tolerance	±20% (120Hz, +20°C)							
Leakage Current(+20°C, max)	1 ≤ 0.01 CV or 3 (µA) After 2 minutes, whichever is greater measured with rated working voltage applied.							
Dissipation Factor (tan δ · at 20°C · 120Hz)	Working Voltage (VDC)	4	6.3	10	16	25	35	50
	D.F. (%)max	35	24	20	16	14	12	10
Low Temperature Characteristics (at 120Hz)	Impedance ratio max							
	Working Voltage (VDC)	4	6.3	10	16	25	35	50
	Z-25°C / Z+20°C	6	3	3	2	2	2	2
	Z-40°C / Z+20°C	12	8	5	4	3	3	3
Endurance	Test conditions							
	Duration time	:1000 Hrs						
	Ambient temperature	:+105°C						
	Applied voltage	:Rated DC working voltage						
	After test requirement at +20°C							
	Capacitance change	:≤ ±20% of the initial measured value (4V : ≤±30%)						
	Dissipation factor	:≤ 200% of the initial specified value						
Leakage current	:≤ The initial specified value							
Shelf Life	Test conditions							
	Duration time	:1000 Hrs						
	Ambient temperature	:+105°C						
Applied voltage	:None							
	After test requirement at +20°C : Same limits as Endurance. Pre-treatment for measurements shall be conducted after application of DC working voltage for 30 minutes.							

Multiplier for Ripple Current vs. Frequency

CAP(µF)\Frequency(Hz)	50(60)	120	1K	≥10K
0.1~47	0.8	1	1.30	1.50
100~220	0.8	1	1.15	1.20

Diagram of Dimensions:(unit:mm)

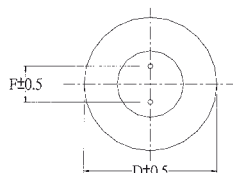
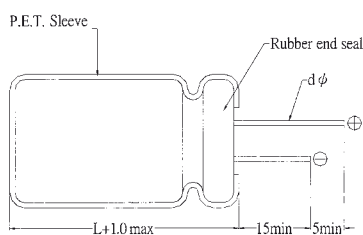

D φ	4	5	6.3	8
F	1.5±0.5	2.0±0.5	2.5±0.5	3.5±0.5
d φ	0.45			

Case Size

WV Cap(μF)	4		6.3		10		16		25		35		50		
	Size	Ripple	Size	Ripple	Size	Ripple	Size	Ripple	Size	Ripple	Size	Ripple	Size	Ripple	
0.1													4x5	1.5	
0.15													4x5	2.0	
0.22													4x5	2.6	
0.33													4x5	3.2	
0.47													4x5	3.8	
0.68													4x5	5	
1													4x5	6.2	
1.5													4x5	7	
2.2											4x5	7.5	4x5	11	
3.3													4x5	14	
4.7										4x5	8.5	4x5	11		
6.8										4x5	13	4x5	15	5x5	19
10										4x5	13	4x5	15	5x5	22
15					4x5	11								6.3x5	25
22					4x5	15	4x5	18	5x5	23	5x5	25	6.3x5	30	
33	4x5	10	4x5	12											
47	4x5	13	4x5	15	4x5	18	5x5	23	6.3x5	32	6.3x5	32	8x5	35	
68	4x5	22	4x5	22	5x5	27	5x5	30	6.3x5	39	6.3x5	48	8x5	50	
100	5x5	30	5x5	30	5x5	35	6.3x5	45	6.3x5	48	8x5	50			
220	5x5	36	5x5	36	6.3x5	48	6.3x5	50	6.3x5	50					
									8x5	55					
	6.3x5	52	6.3x5	52	6.3x5	53	8x5	55							
	6.3x5	60	6.3x5	60	8x5	65	8x5	68							
	6.3x5	80	6.3x5	80	8x5	83									

φ DxL(mm)

Ripple Current (mA, rms) at 105°C 120Hz

Radial

SA Series 5 mm, Low Leakage Current 85°C

Features

- ◆ Low leakage current, height 5 mm
- ◆ RoHS Compliant

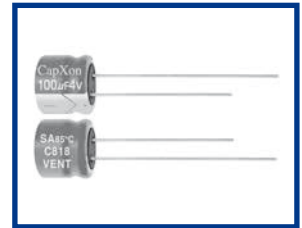

Specifications

Item	Performance Characteristics																
Operating Temperature Range	-40 to +85°C																
Rated Voltage Range	4 to 50 VDC																
Capacitance Range	0.1 to 100 µF																
Capacitance Tolerance	±20%(120Hz,+20°C)																
Leakage Current(+20°C, max)	$I \leq 0.002 CV$ or $0.4 (\mu A)$ After 2 minutes, whichever is greater measured with rated working voltage applied.																
Dissipation Factor ($\tan \delta$ at 20°C, 120Hz)	<table border="1"> <thead> <tr> <th>Working Voltage (VDC)</th> <th>4</th> <th>6.3</th> <th>10</th> <th>16</th> <th>25</th> <th>35</th> <th>50</th> </tr> </thead> <tbody> <tr> <td>D.F. (%)max</td> <td>35</td> <td>24</td> <td>20</td> <td>16</td> <td>14</td> <td>12</td> <td>10</td> </tr> </tbody> </table>	Working Voltage (VDC)	4	6.3	10	16	25	35	50	D.F. (%)max	35	24	20	16	14	12	10
Working Voltage (VDC)	4	6.3	10	16	25	35	50										
D.F. (%)max	35	24	20	16	14	12	10										
Low Temperature Characteristics (at 120Hz)	Impedance ratio max <table border="1"> <thead> <tr> <th>Working Voltage (VDC)</th> <th>4</th> <th>6.3</th> <th>10</th> <th>16</th> <th>25</th> <th>35</th> <th>50</th> </tr> </thead> <tbody> <tr> <td>Z-40°C / Z+20°C</td> <td>15</td> <td>10</td> <td>8</td> <td>6</td> <td>4</td> <td>3</td> <td>3</td> </tr> </tbody> </table>	Working Voltage (VDC)	4	6.3	10	16	25	35	50	Z-40°C / Z+20°C	15	10	8	6	4	3	3
Working Voltage (VDC)	4	6.3	10	16	25	35	50										
Z-40°C / Z+20°C	15	10	8	6	4	3	3										
Endurance	Test conditions Duration time :1000 Hrs Ambient temperature :+85°C Applied voltage :Rated DC working voltage After test requirement at +20°C Capacitance change :≤ ±20% of the initial measured value (4V : ≤ ±30%) Dissipation factor :≤ 200% of the initial specified value Leakage current :≤ The initial specified value																
Shelf Life	Test conditions Duration time :1000 Hrs Ambient temperature :+85°C Applied voltage :None After test requirement at +20°C : Same limits as Endurance. Pre-treatment for measurements shall be conducted after application of DC working voltage for 30 minutes.																

Multiplier for Ripple Current vs. Frequency

CAP(µ F)\Frequency(Hz)	50(60)	120	1K	≥10K
0.1~47	0.8	1	1.30	1.50
100	0.8	1	1.15	1.20

Diagram of Dimensions:(unit:mm)

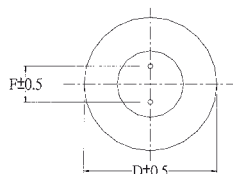
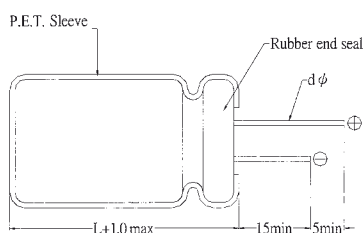

D φ	4	5	6.3	8
F	1.5±0.5	2.0±0.5	2.5±0.5	3.5±0.5
d φ	0.45			

Case Size

WV Cap(μF)	4		6.3		10		16		25		35		50	
	Size	Ripple	Size	Ripple	Size	Ripple	Size	Ripple	Size	Ripple	Size	Ripple	Size	Ripple
0.1													4x5	1.0
0.22													4x5	2.0
0.33													4x5	2.8
0.47													4x5	4.0
1													4x5	8.4
2.2													4x5	13
3.3													5x5	17
4.7									4x5	16	4x5	18	5x5	20
10							4x5	25	5x5	27	5x5	29	6.3x5	33
22			4x5	28	4x5	32	5x5	37	6.3x5	42	6.3x5	46	8x5	60
33	5x5	28	5x5	37	5x5	41	6.3x5	49	6.3x5	52				
47	5x5	33	5x5	45	6.3x5	52	6.3x5	58						
100	6.3x5	56	6.3x5	70										

φ DxL(mm)

Ripple Current (mA, rms) at 85°C 120Hz

SP Series 5 mm, Non-polar 85°C

Features

- ◆ Non-polarized with 5 mm for crossover networks of height-pitched, mean and low pitched sounds in high-fidelity sound systems.
- ◆ The series offers excellent frequency characteristics and minimal capacitance deviation with frequency.
- ◆ RoHS Compliant

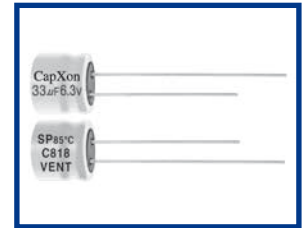

Specifications

Item	Performance Characteristics																					
Operating Temperature Range	-40 to +85°C																					
Rated Voltage Range	6.3 to 50 VDC																					
Capacitance Range	0.1 to 47 µF																					
Capacitance Tolerance	±20% (120Hz, +20°C)																					
Leakage Current(+20°C, max)	$I \leq 0.05 CV$ or 10 (µA) After 2 minutes, whichever is greater measured with rated working voltage applied.																					
Dissipation Factor (tan δ, at 20°C, 120Hz)	<table border="1"> <tr> <td>Working Voltage (VDC)</td> <td>6.3</td> <td>10</td> <td>16</td> <td>25</td> <td>35</td> <td>50</td> </tr> <tr> <td>D.F. (%)max</td> <td>24</td> <td>20</td> <td>17</td> <td>17</td> <td>15</td> <td>15</td> </tr> </table>	Working Voltage (VDC)	6.3	10	16	25	35	50	D.F. (%)max	24	20	17	17	15	15							
Working Voltage (VDC)	6.3	10	16	25	35	50																
D.F. (%)max	24	20	17	17	15	15																
Low Temperature Characteristics (at 120Hz)	Impedance ratio max <table border="1"> <tr> <td>Working Voltage (VDC)</td> <td>6.3</td> <td>10</td> <td>16</td> <td>25</td> <td>35</td> <td>50</td> </tr> <tr> <td>Z-25°C / Z+20°C</td> <td>4</td> <td>3</td> <td>2</td> <td>2</td> <td>2</td> <td>2</td> </tr> <tr> <td>Z-40°C / Z+20°C</td> <td>8</td> <td>6</td> <td>4</td> <td>4</td> <td>3</td> <td>3</td> </tr> </table>	Working Voltage (VDC)	6.3	10	16	25	35	50	Z-25°C / Z+20°C	4	3	2	2	2	2	Z-40°C / Z+20°C	8	6	4	4	3	3
Working Voltage (VDC)	6.3	10	16	25	35	50																
Z-25°C / Z+20°C	4	3	2	2	2	2																
Z-40°C / Z+20°C	8	6	4	4	3	3																
Endurance	Test conditions Duration time :1000 Hrs Ambient temperature :+85°C Applied voltage :Rated DC working voltage to each polarity for 500 Hrs After test requirement at +20°C Capacitance change :≤ ±20% of the initial measured value (4V : ≤ ±30%) Dissipation factor :≤ 200% of the initial specified value Leakage current :≤ The initial specified value																					
Shelf Life	Test conditions Duration time :1000 Hrs Ambient temperature :+85°C Applied voltage :None After test requirement at +20°C : Same limits as Endurance. Pre-treatment for measurements shall be conducted after application of DC working voltage for 30 minutes.																					

Multiplier for Ripple Current vs. Frequency

CAP(µF)\Frequency(Hz)	60(50)	120	400	1K	10K	50K-100K
CAP≤10	0.8	1	1.30	1.45	1.65	1.70
10<CAP≤100	0.8	1	1.23	1.36	1.48	1.53
100<CAP≤1000	0.8	1	1.16	1.25	1.35	1.38

Diagram of Dimensions:(unit:mm)

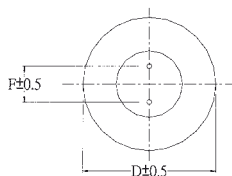
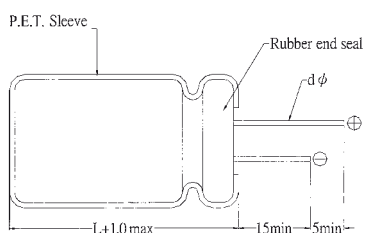

D φ	4	5	6.3
F	1.5±0.5	2.0±0.5	2.5±0.5
d φ	0.45		

Case Size

WV Cap(μF)		φ DxL(mm)											
		6.3		10		16		25		35		50	
		Size	Ripple	Size	Ripple	Size	Ripple	Size	Ripple	Size	Ripple	Size	Ripple
0.1												4x5	1
0.22												4x5	2
0.33												4x5	2.8
0.47												4x5	4
1												4x5	8
2.2										4x5	8.5	5x5	13
3.3						4x5	10	5x5	13	5x5	14	5x5	15
4.7						4x5	12	5x5	15	5x5	16	6.3x5	18
10		4x5	15	4x5	16	5x5	23	6.3x5	25	6.3x5	28		
				5x5	18								
22		5x5	27	6.3x5	32	6.3x5	36						
33		6.3x5	35	6.3x5	40	6.3x5	47						
47		6.3x5	44										

Ripple Current (mA, rms) at 85°C 120Hz

SM Series 7 mm 85°C Standard

Features

- ◆ Design for space-saving and high density insertion.
- ◆ Applications: VTR, car radio, car stereos, charger, etc.
- ◆ RoHS Compliant

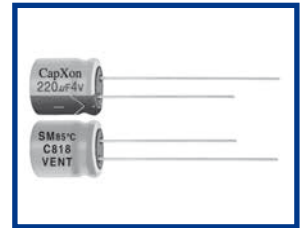

Specifications

Item	Performance Characteristics								
Operating Temperature Range	-40 to +85°C								
Rated Voltage Range	4 to 63 VDC								
Capacitance Range	0.1 to 470 µF								
Capacitance Tolerance	±20% (120Hz, +20°C)								
Leakage Current(+20°C, max)	I ≤ 0.01 CV or 3 (µA) After 1 minute, whichever is greater measured with rated working voltage applied.								
Dissipation Factor (tan δ · at 20°C · 120Hz)	Working Voltage (VDC)	4	6.3	10	16	25	35	50	63
	D.F. (%)max	25	22	20	16	14	12	10	9
Low Temperature Characteristics (at 120Hz)	Impedance ratio max								
	Working Voltage (VDC)	4	6.3	10	16	25	35	50	63
	Z-25°C / Z+20°C	7	4	3	2	2	2	2	2
	Z-40°C / Z+20°C	15	8	6	4	4	3	3	3
Endurance	Test conditions								
	Duration time	:1000 Hrs							
	Ambient temperature	:+85°C							
	Applied voltage	:Rated DC working voltage							
	After test requirement at +20°C								
	Capacitance change	:≤ ±20% of the initial measured value (4V : ≤ ±30%)							
	Dissipation factor	:≤ 200% of the initial specified value							
	Leakage current	:≤ The initial specified value							
Shelf Life	Test conditions								
	Duration time	:1000 Hrs							
	Ambient temperature	:+85°C							
	Applied voltage	:None							
	After test requirement at +20°C : Same limits as Endurance.								
	Pre-treatment for measurements shall be conducted after application of DC working voltage for 30 minutes.								

Multiplier for Ripple Current vs. Frequency

CAP(µF)\Frequency(Hz)	60(50)	120	400	1K	10K	50K-100K
CAP ≤ 10	0.8	1	1.30	1.45	1.65	1.70
10 < CAP ≤ 100	0.8	1	1.23	1.36	1.48	1.53
100 < CAP ≤ 1000	0.8	1	1.16	1.25	1.35	1.38

Diagram of Dimensions:(unit:mm)

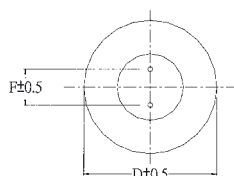
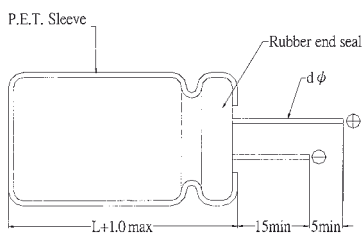

D φ	4	5	6.3	8
F	1.5±0.5	2.0±0.5	2.5±0.5	3.5±0.5
d φ	0.45		0.5	

Case Size

φ DxL(mm)

WV Cap(μF)	4		6.3		10		16		25	
	Size	Ripple	Size	Ripple	Size	Ripple	Size	Ripple	Size	Ripple
4.7							4x7	15	4x7	20
6.8							4x7	20	4x7	22
10							4x7	28	4x7	30
15			4x7	28	4x7	32	4x7	35	5x7	37
22			4x7	35	4x7	36	4x7	40	4x7	46
33	4x7	33			5x7	38	5x7	42	5x7	50
			4x7	40	4x7	43	4x7	45	5x7	52
47	4x7	35	5x7	42	5x7	45	5x7	55	6.3x7	58
			4x7	46	4x7	50	5x7	65	6.3x7	71
68	4x7	42	5x7	48	5x7	58	6.3x7	68		
			5x7	50	5x7	60	6.3x7	70	6.3x7	79
100	4x7	55	5x7	75	5x7	82	6.3x7	98	8x7	113
			5x7	61	6.3x7	80	6.3x7	90	8x7	105
150	5x7	72	6.3x7	82	6.3x7	95	8x7	111		
			8x7	85						
220	6.3x7	110	6.3x7	120	6.3x7	136	8x7	152		
			8x7	133	8x7	140				
330	6.3x7	120	8x7	160	8x7	182				
			8x7	165						
470	8x7	235								

WV Cap(μF)	35		50		63	
	Size	Ripple	Size	Ripple	Size	Ripple
0.1			4x7	1.3	4x7	1.3
0.15			4x7	2	4x7	2.0
0.22			4x7	3	4x7	3.0
0.33			4x7	3.5	4x7	4.0
0.47			4x7	5	4x7	6.3
0.68			4x7	7.5	4x7	8
1			4x7	10	4x7	12
1.5			4x7	13	4x7	14
2.2			4x7	17	4x7	18
3.3	4x7	18	4x7	23	5x7	25
			4x7	22	4x7	30
4.7	4x7		5x7	26	6.3x7	33
			5x7	25	5x7	28
10	4x7	31	5x7	35	6.3x7	48
			5x7	33	6.3x7	38
15	5x7	37	6.3x7	42	8x7	45
			5x7	47	6.3x7	59
22	6.3x7	55	8x7	63		
			6.3x7	65	8x7	75
33	8x7	68				
			8x7	85	8x7	88
68	8x7	88				
100	8x7	119				

Ripple Current (mA, rms) at 85°C 120Hz

Radial

SH Series 7 mm 85°C Long Life

Features

- ◆ Long life 2000 hrs.
- ◆ Design for space-saving and high density insertion.
- ◆ Applications: VTR, car radio, car stereos, charger, etc.
- ◆ RoHS Compliant

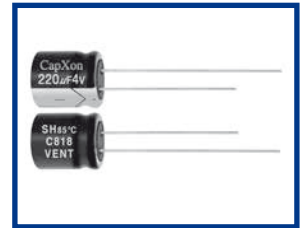

Specifications

Item	Performance Characteristics								
Operating Temperature Range	-40 to +85°C								
Rated Voltage Range	4 to 63 VDC								
Capacitance Range	0.1 to 470 µF								
Capacitance Tolerance	±20% (120Hz, +20°C)								
Leakage Current(+20°C, max)	I ≤ 0.01 CV or 3 (µA) After 1 minute, whichever is greater measured with rated working voltage applied.								
Dissipation Factor (tan δ · at 20°C · 120Hz)	Working Voltage (VDC)	4	6.3	10	16	25	35	50	63
	D.F. (%)max	25	22	20	16	14	12	10	9
Low Temperature Characteristics (at 120Hz)	Impedance ratio max								
	Working Voltage (VDC)	4	6.3	10	16	25	35	50	63
	Z-25°C / Z+20°C	7	4	3	2	2	2	2	2
Endurance	Test conditions								
	Duration time	:2000 Hrs							
	Ambient temperature	:+85°C							
	Applied voltage	:Rated DC working voltage							
Shelf Life	After test requirement at +20°C								
	Capacitance change	: ≤ ±20% of the initial measured value (4V : ≤ ±30%)							
	Dissipation factor	: ≤ 200% of the initial specified value							
	Leakage current	: ≤ The initial specified value							
Shelf Life	Test conditions								
	Duration time	:1000 Hrs							
	Ambient temperature	:+85°C							
Applied voltage :None									
After test requirement at +20°C : Same limits as Endurance.									
Pre-treatment for measurements shall be conducted after application of DC working voltage for 30 minutes.									

Multiplier for Ripple Current vs. Frequency

CAP(µF)\Frequency(Hz)	60(50)	120	400	1K	10K	50K-100K
CAP ≤ 10	0.8	1	1.30	1.45	1.65	1.70
10 < CAP ≤ 100	0.8	1	1.23	1.36	1.48	1.53
100 < CAP ≤ 1000	0.8	1	1.16	1.25	1.35	1.38

Diagram of Dimensions:(unit:mm)

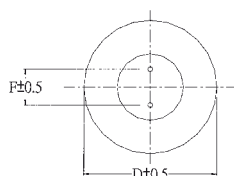
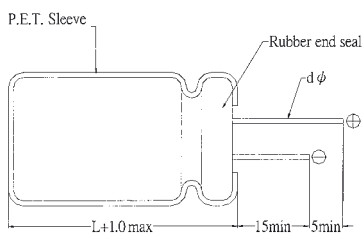

D φ	4	5	6.3	8
F	1.5±0.5	2.0±0.5	2.5±0.5	3.5±0.5
d φ	0.45		0.5	

Case Size

WV Cap(μF)		φ DxL(mm)									
		4		6.3		10		16		25	
		Size	Ripple	Size	Ripple	Size	Ripple	Size	Ripple	Size	Ripple
4.7										4x7	17
6.8								4x7	20	4x7	21
10								4x7	30	4x7	30
15										5x7	33
22		4x7	23	4x7	31	4x7	28	4x7	32	5x7	38
33		4x7	26	4x7	32	4x7	35	4x7	37	5x7	45
47		4x7	35	5x7	35	5x7	45	5x7	42	6.3x7	48
68		4x7	35	4x7	40	4x7	40	4x7	45	5x7	52
				5x7	47	5x7	51	5x7	50	6.3x7	60
		5x7	55	5x7	55	5x7	60	6.3x7	61	8x7	72
						6.3x7	68	6.3x7	67	6.3x7	75
100		5x7	58	5x7	65	5x7	80	6.3x7	72	8x7	115
				6.3x7	75	6.3x7	90	8x7	95		
220		6.3x7	65	6.3x7	70	6.3x7	105		105		
330		6.3x7	90	8x7	90	8x7	125				
470		8x7	120	8x7	120						

WV Cap(μF)		35		50		63	
		Size	Ripple	Size	Ripple	Size	Ripple
0.1				4x7	1.5	4x7	1.5
0.15				4x7	1.8	4x7	1.8
0.22				4x7	2.5	4x7	2.5
0.33				4x7	3.5	4x7	3.5
0.47				4x7	5	4x7	6
0.68				4x7	7	4x7	7
1				4x7	10	4x7	12
1.5				4x7	13	4x7	14
2.2				4x7	19	4x7	19
3.3				4x7	24	5x7	25
4.7		4x7	22	4x7	27	5x7	29
				5x7	29	6.3x7	33
6.8		4x7	24	5x7	32	6.3x7	35
		5x7	28	6.3x7	33		
10		4x7	30	5x7	35	6.3x7	40
		5x7	35	6.3x7	38		
15		5x7	38	6.3x7	52	8x7	55
		6.3x7	45				
22		5x7	50	6.3x7	60	8x7	65
		6.3x7	58	8x7	63		
33		6.3x7	54	8x7	78		
		8x7	68				
47		8x7	80				
68		8x7	85				

Ripple Current (mA, rms) at 85°C 120Hz

SK Series 7 mm Standard 105°C

Features

- ◆ Design for space-saving and high density insertion.
- ◆ Applications: VTR, car radio, car stereos. charger, etc.
- ◆ RoHS Compliant

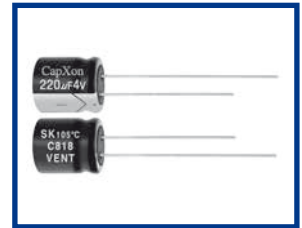

Specifications

Item	Performance Characteristics								
Operating Temperature Range	-40 to +105°C								
Rated Voltage Range	4 to 63 VDC								
Capacitance Range	0.1 to 470 µF								
Capacitance Tolerance	±20% (120Hz, +20°C)								
Leakage Current(+20°C, max)	I ≤ 0.01 CV or 3 (µA) After 1 minute, whichever is greater measured with rate working voltage applied.								
Dissipation Factor (tan δ · at 20°C · 120Hz)	Working Voltage (VDC)	4	6.3	10	16	25	35	50	63
	D.F. (%)max	25	22	20	16	14	12	10	9
Low Temperature Characteristics (at 120Hz)	Impedance ratio max								
	Working Voltage (VDC)	4	6.3	10	16	25	35	50	63
	Z-25°C / Z+20°C	7	4	3	2	2	2	2	2
	Z-40°C / Z+20°C	15	8	6	4	4	3	3	3
Endurance	Test conditions								
	Duration time	:1000 Hrs							
	Ambient temperature	:+105°C							
	Applied voltage	:Rated DC working voltage							
	After test requirement at +20°C								
	Capacitance change	:≤ ±20% of the initial measured value (4V : ≤ ±30%)							
	Dissipation factor	:≤ 200% of the initial specified value							
Leakage current	:≤ The initial specified value								
Shelf Life	Test conditions								
	Duration time	:1000 Hrs							
	Ambient temperature	:+105°C							
	Applied voltage	:None							
After test requirement at +20°C : Same limits as Endurance.									
Pre-treatment for measurements shall be conducted after application of DC working voltage for 30 minutes.									

Multiplier for Ripple Current vs. Frequency

CAP(µF)\Frequency(Hz)	50(60)	120	400	1K	10K	50K-100K
CAP ≤ 10	0.8	1	1.30	1.45	1.65	1.70
10 < CAP ≤ 100	0.8	1	1.23	1.36	1.48	1.53
100 < CAP ≤ 1000	0.8	1	1.16	1.25	1.35	1.38

Diagram of Dimensions:(unit:mm)

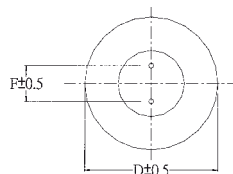
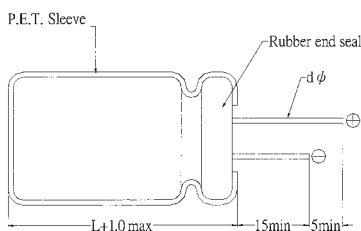

D φ	4	5	6.3	8
F	1.5±0.5	2.0±0.5	2.5±0.5	3.5±0.5
d φ	0.45		0.5	

Case Size

φ DxL(mm)

WV Cap(μF)	4		6.3		10		16		25	
	Size	Ripple	Size	Ripple	Size	Ripple	Size	Ripple	Size	Ripple
4.7									4x7	17
6.8							4x7	20	4x7	21
10							4x7	30	4x7	30
15									5x7	33
22	4x7	23	4x7	31	4x7	28	4x7	32	5x7	38
33	4x7	26	4x7	32	4x7	35	4x7	37	5x7	45
47	4x7	35	5x7	35	5x7	40	5x7	42	6.3x7	48
68	5x7	55	5x7	40	5x7	45	5x7	50	6.3x7	60
100	5x7	58	5x7	47	5x7	51	6.3x7	61	8x7	68
220	6.3x7	65	6.3x7	55	6.3x7	60	6.3x7	67	6.3x7	72
330	6.3x7	90	8x7	65	8x7	68	8x7	72		
470	8x7	120	6.3x7	75	6.3x7	80	6.3x7	95	8x7	115
			8x7	90	8x7	90	8x7	105		
			8x7	120	8x7	105				
						150				

WV Cap(μF)	35		50		63	
	Size	Ripple	Size	Ripple	Size	Ripple
0.1			4x7	1.5	4x7	1.5
0.15			4x7	1.8	4x7	1.8
0.22			4x7	2.5	4x7	2.5
0.33			4x7	3.5	4x7	3.5
0.47			4x7	5	4x7	6
0.68			4x7	7	4x7	7
1			4x7	10	4x7	12
1.5			4x7	13	4x7	14
2.2			4x7	19	4x7	19
3.3			4x7	24	5x7	25
4.7	4x7	22	4x7	27	5x7	29
6.8	4x7	24	5x7	29	6.3x7	33
10	5x7	28	6.3x7	32	6.3x7	35
15	5x7	30	5x7	33		
22	6.3x7	35	6.3x7	35	6.3x7	40
33	8x7	38	6.3x7	38		
47	8x7	45		52	8x7	55
68	8x7	50	6.3x7	60	8x7	65
		58	8x7	63		
		54	8x7	78		
		68				
		80				
		85				

Ripple Current (mA, rms) at 105°C 120Hz

Radial

SJ Series 7 mm 105°C Long Life

Features

- ◆ Design for space-saving and high density insertion.
- ◆ Applications: VTR, car radio, car stereos, charger, etc.
- ◆ RoHS Compliant

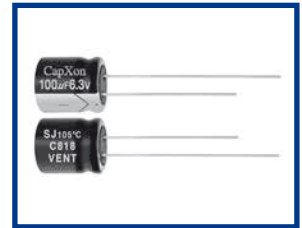

Specifications

Item	Performance Characteristics							
Operating Temperature Range	-40 to +105°C							
Rated Voltage Range	6.3 to 63 VDC							
Capacitance Range	0.1 to 220 µF							
Capacitance Tolerance	±20% (120Hz, +20°C)							
Leakage Current(+20°C, max)	I ≤ 0.01 CV or 3 (µA) After 1 minute, whichever is greater measured with rate working voltage applied.							
Dissipation Factor (tan δ · at 20°C · 120Hz)	Working Voltage (VDC)	6.3	10	16	25	35	50	63
	D.F. (%)max	24	20	16	14	12	10	9
Low Temperature Characteristics (at 120Hz)	Impedance ratio max							
	Working Voltage (VDC)	6.3	10	16	25	35	50	63
	Z-25°C / Z+20°C	4	3	2	2	2	2	2
	Z-40°C / Z+20°C	8	6	4	4	3	3	3
Endurance	Test conditions							
	Duration time	:2000 Hrs						
	Ambient temperature	:+105°C						
	Applied voltage	:Rated DC working voltage						
	After test requirement at +20°C							
	Capacitance change	:≤ ±20% of the initial measured value (4V : ≤ ±30%)						
	Dissipation factor	:≤ 200% of the initial specified value						
	Leakage current	:≤ The initial specified value						
Shelf Life	Test conditions							
	Duration time	:1000 Hrs						
	Ambient temperature	:+105°C						
	Applied voltage	:None						
	After test requirement at +20°C : Same limits as Endurance.							
	Pre-treatment for measurements shall be conducted after application of DC working voltage for 30 minutes.							

Multiplier for Ripple Current vs. Frequency

CAP(µF)\Frequency(Hz)	50(60)	120	400	1K	10K	50K-100K
CAP ≤ 10	0.8	1	1.30	1.45	1.65	1.70
10 < CAP ≤ 220	0.8	1	1.23	1.36	1.48	1.53

Diagram of Dimensions:(unit:mm)

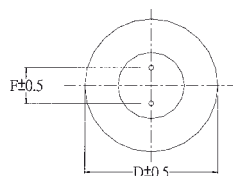
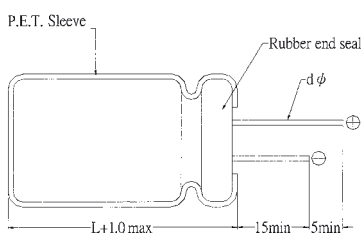

D φ	4	5	6.3	8
F	1.5±0.5	2.0±0.5	2.5±0.5	3.5±0.5
d φ	0.45		0.5	

Case Size

φ DxL(mm)

WV Cap(μF)	6.3		10		16		25	
	Size	Ripple	Size	Ripple	Size	Ripple	Size	Ripple
4.7							4x7	17
6.8					4x7	19	4x7	19
10					4x7	28	4x7	28
15							5x7	33
15			4x7	26	4x7	30	5x7	35
22	4x7	28	4x7	32	4x7	35	5x7	43
33					5x7	42	6.3x7	45
	4x7	32	5x7	48	5x7	50	6.3x7	62
47								
	5x7	47	5x7	51	6.3x7	67	8x7	75
68					6.3x7	70	8x7	80
	5x7	50	6.3x7	68	8x7	78		
100					8x7	110	8x7	115
	6.3x7	75	6.3x7	80				
220	8x7	92	8x7	130				

WV Cap(μF)	35		50		63	
	Size	Ripple	Size	Ripple	Size	Ripple
0.1			4x7	1.5	4x7	1.5
0.15			4x7	1.8	4x7	1.8
0.22			4x7	2.5	4x7	2.5
0.33			4x7	3.5	4x7	3.5
0.47			4x7	5	4x7	6
0.68			4x7	7	4x7	7
1			4x7	10	4x7	12
1.5			4x7	13	4x7	14
2.2			4x7	20	4x7	20
3.3			4x7	26	5x7	28
4.7	4x7	22	4x7	27	5x7	29
			5x7	29	6.3x7	33
6.8	4x7	24	5x7	32	6.3x7	35
	5x7	28	6.3x7	33		
10						
	5x7	35	6.3x7	38	6.3x7	40
15						
	5x7	38	6.3x7	52	8x7	55
22						
	6.3x7	45				
33						
	6.3x7	60	8x7	63	8x7	65
47						
	6.3x7	50	8x7	78		
68						
	8x7	68				
	8x7	80				
	8x7	85				

Ripple Current (mA, rms) at 105°C 120Hz

Radial

SG Series 7~9mm Long life

Features

- ◆ Operating temperature -40~105°C.
- ◆ 105°C 4000Hours assured.
- ◆ 7~9mm Height

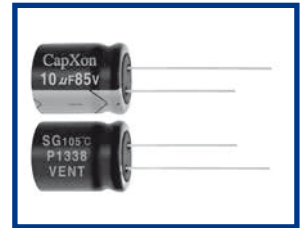

Specifications

Item	Performance Characteristics																					
Operating Temperature Range	-40 to +105°C																					
Rated Voltage Range	6.3 to 50 VDC																					
Capacitance Range	0.1 to 470 μ F																					
Capacitance Tolerance	±20%(120Hz,+20°C)																					
Leakage Current (+20°C,max.)	$I \leq 0.01 CV$ or $3 (\mu A)$ After 2 minute with rated working voltage applied.																					
Dissipation Factor ($\tan \delta$ · at 20°C · 120Hz)	<table border="1"> <tr> <td>Working Voltage(VDC)</td> <td>6.3</td> <td>10</td> <td>16</td> <td>25</td> <td>35</td> <td>50</td> </tr> <tr> <td>D.F.(%)max.</td> <td>64</td> <td>20</td> <td>17</td> <td>15</td> <td>13</td> <td>12</td> </tr> </table>	Working Voltage(VDC)	6.3	10	16	25	35	50	D.F.(%)max.	64	20	17	15	13	12							
	Working Voltage(VDC)	6.3	10	16	25	35	50															
D.F.(%)max.	64	20	17	15	13	12																
Low Temperature Characteristics (at 120Hz)	Impedance ratio max																					
	<table border="1"> <tr> <td>Working Voltage(VDC)</td> <td>6.3</td> <td>10</td> <td>16</td> <td>25</td> <td>35</td> <td>50</td> </tr> <tr> <td>Z-25°C / Z+20°C</td> <td>4</td> <td>3</td> <td>2</td> <td>2</td> <td>2</td> <td>2</td> </tr> <tr> <td>Z-55°C / Z+20°C</td> <td>8</td> <td>6</td> <td>4</td> <td>3</td> <td>3</td> <td>3</td> </tr> </table>	Working Voltage(VDC)	6.3	10	16	25	35	50	Z-25°C / Z+20°C	4	3	2	2	2	2	Z-55°C / Z+20°C	8	6	4	3	3	3
	Working Voltage(VDC)	6.3	10	16	25	35	50															
Z-25°C / Z+20°C	4	3	2	2	2	2																
Z-55°C / Z+20°C	8	6	4	3	3	3																
Endurance	Test condition Duration time :4000Hrs Ambient temperature :+105°C Applied voltage :Rated DC working voltage After test requirement at +20°C Capacitance change : within ± 30% of the initial measured value Dissipation factor : ≤300% of the initial specified value Leakage current : ≤The initial specified value																					
Shelf Life	Test condition Duration time :1000Hrs Ambient temperature :+105°C Applied voltage :None After test requirement at +20°C:Same limits as Endurance. Pre-treatment for measurements shall be conducted after application of DC working voltage for 30 minutes.																					

Multiplier for Ripple Current vs. Frequency

CAP(μ F)\Frequency(Hz)	50(60)	120	1K	50-100K
Multiplier	0.65	1.00	1.35	1.5

Diagram of Dimensions:(unit:mm)

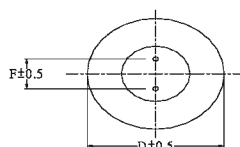
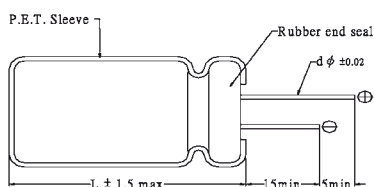

D φ	4	5	6.3	8	10
F	1.5	2.0	2.5	3.5	5.0
d φ	0.45		0.50	0.50	0.6

Case Size

φ DxL(mm)

100WV Cap(μF)	6.3		10		16		25		35		50	
	Size	Ripple	Size	Ripple	Size	Ripple	Size	Ripple	Size	Ripple	Size	Ripple
0.1											4X7	1.5
0.22											4X7	2.5
0.33											4X7	3.5
0.47											4X7	5
1											4X7	12
2.2											4X7	21
3.3											4X7	26
4.7											5X7	31
10					4X7	29	5X7	36	4X7	26	6.3X7	46
					5X7	29						
22	4X7	35	5X7	42	5X7	46	6.3X7	52	6.3X7	60	8X7	67
33	5X7	43	5X7	50	6.3X7	58	6.3X7	65	8X7	75	8X9	89
47	5X7	50	6.3X7	60	6.3X7	70	6.3X7	70	8X9	89	8X9	89
							8X7	80				
100	6.3X7	76	8X7	96	6.3X7	95	8X7	100	10X9	165	10X9	165
					8X7	110	8X9	145				
150							8X9	145				
220	8X7	131	8X9	145	8X9	145	10X9	165				
330	8X9	145	8X9	145	8X9	145						
					10X9	165						
470	8X9	145	8X9	145	10X9	165						
			10X9	165								

Ripple Current(mA,rms) at 105°C 120KHZ

SL Series 7 mm, Low Leakage Current 85°C

Features

- ◆ Low leakage current, height 7 mm
- ◆ RoHS Compliant

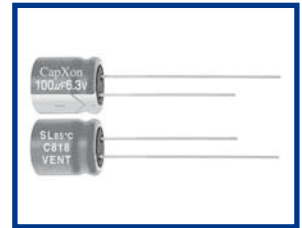

Specifications

Item	Performance Characteristics														
Operating Temperature Range	-40 to +85°C														
Rated Voltage Range	6.3 to 50 VDC														
Capacitance Range	0.1 to 220 µF														
Capacitance Tolerance	±20% (120Hz, +20°C)														
Leakage Current(+20°C, max)	$I \leq 0.002 CV$ or $0.4 (\mu A)$ After 2 minutes, whichever is greater measured with rated working voltage applied.														
Dissipation Factor ($\tan \delta$ at 20°C, 120Hz)	<table border="1"> <tr> <td>Working Voltage (VDC)</td> <td>6.3</td> <td>10</td> <td>16</td> <td>25</td> <td>35</td> <td>50</td> </tr> <tr> <td>D.F. (%)max</td> <td>22</td> <td>20</td> <td>16</td> <td>14</td> <td>12</td> <td>10</td> </tr> </table>	Working Voltage (VDC)	6.3	10	16	25	35	50	D.F. (%)max	22	20	16	14	12	10
Working Voltage (VDC)	6.3	10	16	25	35	50									
D.F. (%)max	22	20	16	14	12	10									
Low Temperature Characteristics (at 120Hz)	Impedance ratio max <table border="1"> <tr> <td>Working Voltage (VDC)</td> <td>6.3</td> <td>10</td> <td>16</td> <td>25</td> <td>35</td> <td>50</td> </tr> <tr> <td>Z-40°C / Z+20°C</td> <td>8</td> <td>6</td> <td>4</td> <td>4</td> <td>3</td> <td>3</td> </tr> </table>	Working Voltage (VDC)	6.3	10	16	25	35	50	Z-40°C / Z+20°C	8	6	4	4	3	3
Working Voltage (VDC)	6.3	10	16	25	35	50									
Z-40°C / Z+20°C	8	6	4	4	3	3									
Endurance	Test conditions Duration time :1000 Hrs Ambient temperature :+85°C Applied voltage :Rated DC working voltage After test requirement at +20°C Capacitance change :≤ ±20% of the initial measured value (4V : ≤ ±30%) Dissipation factor :≤ 200% of the initial specified value Leakage current :≤ The initial specified value														
Shelf Life	Test conditions Duration time :1000 Hrs Ambient temperature :+85°C Applied voltage :None After test requirement at +20°C : Same limits as Endurance. Pre-treatment for measurements shall be conducted after application of DC working voltage for 30 minutes.														

Multiplier for Ripple Current vs. Frequency

CAP(µF)\Frequency(Hz)	50(60)	120	400	1K	10K	50K-100K
CAP ≤ 10	0.8	1	1.30	1.45	1.65	1.70
10 < CAP ≤ 220	0.8	1	1.23	1.36	1.48	1.53

Diagram of Dimensions:(unit:mm)

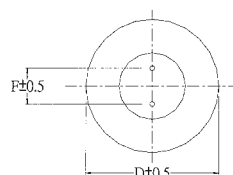
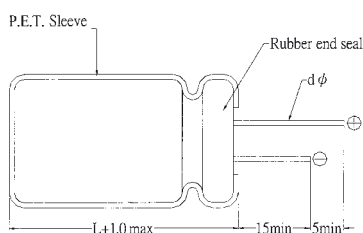

D φ	4	5	6.3	8
F	1.5±0.5	2.0±0.5	2.5±0.5	3.5±0.5
d φ	0.45		0.5	

Case Size

φ DxL(mm)

WV Cap(μF)	6.3		10		16		25		35		50	
	Size	Ripple	Size	Ripple	Size	Ripple	Size	Ripple	Size	Ripple	Size	Ripple
0.1											4x7	0.8
0.22											4x7	2.0
0.33											4x7	3.1
0.47											4x7	4.5
1											4x7	8.0
2.2											4x7	16
3.3											4x7	21
4.7									4x7	21	5x7	25
10					4x7	25	5x7	30	5x7	33	6.3x7	40
22	4x7	31	5x7	35	5x7	40	6.3x7	48	6.3x7	52	8x7	58
33	5x7	40	5x7	44	6.3x7	53	6.3x7	59	8x7	65		
47	5x7	48	6.3x7	55	6.3x7	60	8x7	73				
100	6.3x7	70	8x7	90	8x7	95						
220	8x7	110										

Ripple Current (mA, rms) at 85°C 120Hz

SD Series 7 mm, Low Leakage Current 105°C

Features

- ◆ 105°C Low leakage current, height 7 mm
- ◆ RoHS Compliant

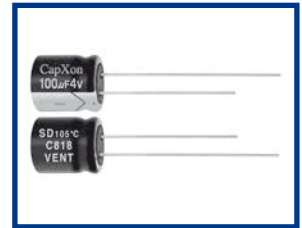

Specifications

Item	Performance Characteristics								
Operating Temperature Range	40 to +105°C								
Rated Voltage Range	4 to 63 VDC								
Capacitance Range	0.1 to 100 µF								
Capacitance Tolerance	±20% (120Hz, +20°C)								
Leakage Current(+20°C, max)	I ≤ 0.002 CV or 0.4 (µA) After 2 minutes, whichever is greater measured with rated working voltage applied.								
Dissipation Factor (tan δ · at 20°C · 120Hz)	Working Voltage (VDC)	4	6.3	10	16	25	35	50	63
	D.F. (%)max	25	22	20	16	14	12	10	10
Low Temperature Characteristics (at 120Hz)	Impedance ratio max								
	Rated voltage(VDC)	4	6.3	10	16	25	35	50	63
	Z-25°C/Z+20°C	6	4	3	3	2	2	2	2
	Z-40°C/Z+20°C	12	10	6	6	4	4	4	3
Endurance	Test conditions								
	Duration time	:1000 Hrs							
	Ambient temperature	:+105°C							
	Applied voltage	:Rated DC working voltage							
	After test requirement at +20°C								
	Capacitance change	:≤ ±20% of the initial measured value (4V : ≤ ±30%)							
	Dissipation factor	:≤ 200% of the initial specified value							
	Leakage current	:≤ The initial specified value							
Shelf Life	Test conditions								
	Duration time	:1000 Hrs							
	Ambient temperature	:+105°C							
	Applied voltage	:None							
	After test requirement at +20°C : Same limits as Endurance.								
	Pre-treatment for measurements shall be conducted after application of DC working voltage for 30 minutes.								

Multiplier for Ripple Current vs. Frequency

CAP(µF) \ Frequency(Hz)	50(60)	120	400	1K	≥10K
0.1~10	0.65	1.0	1.20	1.30	1.50
10~100	0.8	1.0	1.10	1.15	1.20

Diagram of Dimensions:(unit:mm)

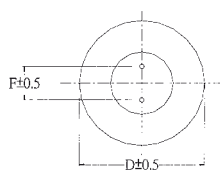
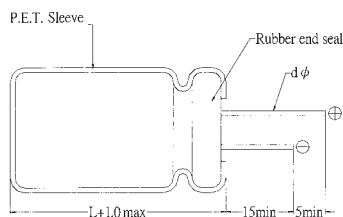

D φ	4	5	6.3	8
F	1.5±0.5	2.0±0.5	2.5±0.5	3.5±0.5
d φ	0.45		0.50	

Case Size

φ DxL(mm)

WV Cap(μF)	4		6.3		10		16	
	Size	Ripple	Size	Ripple	Size	Ripple	Size	Ripple
0.1								
0.22								
0.33								
0.47								
1.0								
2.2								
3.3								
4.7								
10							4x7	27
22					4x7	36	4x7	40
33	4x7	33	4x7	41	5x7	44	5x7	50
47	4x7	39	5x7	49	6.3x7	54	6.3x7	62
100	6.3x7	59	6.3x7	75	8x7	90		

WV Cap(μF)	25		35		50		63	
	Size	Ripple	Size	Ripple	Size	Ripple	Size	Ripple
0.1					4x7	3	4x7	3
0.22					4x7	5	4x7	5
0.33					4x7	6	4x7	6
0.47					4x7	7	4x7	7
1.0					4x7	10	4x7	10
2.2					4x7	16	5x7	19
3.3			4x7	18	4x7	20	6.3x7	29
4.7	4x7	19	5x7	21	6.3x7	24	6.3x7	36
10	5x7	29	5x7	32	8x7	40		
22	6.3x7	44	6.3x7	49				
33	6.3x7	55	8x7	67				
47	8x7	74						
100								

Ripple Current (mA, rms) at 105°C 120Hz

SN Series 7 mm Non-polar 85°C

Features

- ◆ Non-polarized with 7 mm height for crossover networks of high-pitched, mean and low-pitched sounds in high-fidelity sound systems.
- ◆ The series offers excellent frequency characteristics and minimal capacitance deviation with frequency.
- ◆ RoHS Compliant

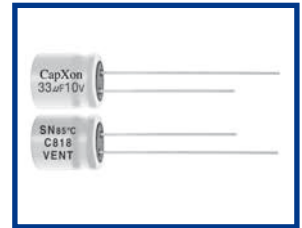

Specifications

Item	Performance Characteristics																					
Operating Temperature Range	-40 to +85°C																					
Rated Voltage Range	6.3 to 50 VDC																					
Capacitance Range	0.1 to 220 µF																					
Capacitance Tolerance	±20% (120Hz, +20°C)																					
Leakage Current(+20°C, max)	$I \leq 0.05 CV$ or $10 (\mu A)$ After 2 minutes, whichever is greater measured with rated working voltage applied.																					
Dissipation Factor (tan δ, at 20°C, 120Hz)	<table border="1"> <tr> <td>Working Voltage (VDC)</td> <td>6.3</td> <td>10</td> <td>16</td> <td>25</td> <td>35</td> <td>50</td> </tr> <tr> <td>D.F. (%)max</td> <td>22</td> <td>20</td> <td>16</td> <td>16</td> <td>14</td> <td>12</td> </tr> </table>	Working Voltage (VDC)	6.3	10	16	25	35	50	D.F. (%)max	22	20	16	16	14	12							
Working Voltage (VDC)	6.3	10	16	25	35	50																
D.F. (%)max	22	20	16	16	14	12																
Low Temperature Characteristics (at 120Hz)	Impedance ratio max <table border="1"> <tr> <td>Rated voltage(VDC)</td> <td>6.3</td> <td>10</td> <td>16</td> <td>25</td> <td>35</td> <td>50</td> </tr> <tr> <td>Z-25°C/Z+20°C</td> <td>4</td> <td>3</td> <td>2</td> <td>2</td> <td>2</td> <td>2</td> </tr> <tr> <td>Z-40°C/Z+20°C</td> <td>8</td> <td>6</td> <td>4</td> <td>4</td> <td>3</td> <td>3</td> </tr> </table>	Rated voltage(VDC)	6.3	10	16	25	35	50	Z-25°C/Z+20°C	4	3	2	2	2	2	Z-40°C/Z+20°C	8	6	4	4	3	3
Rated voltage(VDC)	6.3	10	16	25	35	50																
Z-25°C/Z+20°C	4	3	2	2	2	2																
Z-40°C/Z+20°C	8	6	4	4	3	3																
Endurance	Test conditions Duration time :1000 Hrs Ambient temperature :+85°C Applied voltage :Rated DC working voltage to each polarity for 500 Hrs After test requirement at +20°C Capacitance change :≤ ±20% of the initial measured value Dissipation factor :≤ 200% of the initial specified value Leakage current :≤ The initial specified value																					
Shelf Life	Test conditions Duration time :1000 Hrs Ambient temperature :+85°C Applied voltage :None After test requirement at +20°C : Same limits as Endurance. Pre-treatment for measurements shall be conducted after application of DC working voltage for 30 minutes.																					

Multiplier for Ripple Current vs. Frequency

CAP(µF)\Frequency(Hz)	50(60)	120	400	1K	10K	50K-100K
CAP ≤ 10	0.8	1	1.30	1.45	1.65	1.70
10 < CAP ≤ 220	0.8	1	1.23	1.36	1.48	1.53

Diagram of Dimensions:(unit:mm)

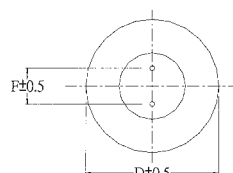
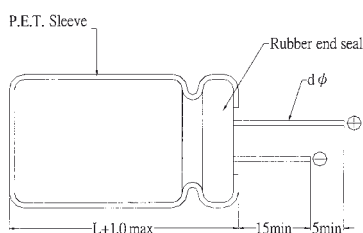

D φ	4	5	6.3	8
F	1.5±0.5	2.0±0.5	2.5±0.5	3.5±0.5
d φ	0.45		0.5	

Case Size

φ DxL(mm)

WV Cap(μF)	6.3		10		16		25		35		50	
	Size	Ripple	Size	Ripple	Size	Ripple	Size	Ripple	Size	Ripple	Size	Ripple
0.1											4x7	1.0
0.22											4x7	2.3
0.33											4x7	3.5
0.47											4x7	5.0
1											4x7	10
2.2									4x7	13	4x7	14
											5x7	16
3.3							4x7	14	4 x7	15	4x7	18
									5x7	16	5x7	20
4.7					4x7	18	4x7	18	5x7	22	6.3x7	27
							5x7	21				
10	4x7	23	4x7	24	4x7	25	6.3x7	35	6.3x7	37	8x7	44
					5x7	30						
22	5x7	30	5x7	38	6.3x7	51	6.3x7	53	8x7	58	8x7	60
33	5x7	40	6.3x7	55	6.3x7	60	8x7	70	8x7	73		
47	6.3x7	56	6.3x7	65	6.3x7	73	8x7	80				
100	8x7	92	8x7	105	8x7	120						
220	8x7	135										

Ripple Current (mA, rms) at 85°C 120Hz

SB Series 7 mm Non-polar 105°C

Features

- ◆ Non-polarized with 7mm height for crossover network of high-pitched, mean and low-pitched sounds in high-frequency sound systems.
- ◆ The series offers excellent frequency characteristics and minimal capacitance deviation with frequency.
- ◆ RoHS Compliant

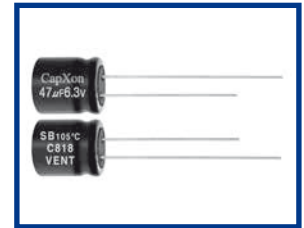

Specifications

Item	Performance Characteristics																					
Operating Temperature Range	-40 to +105°C																					
Rated Voltage Range	6.3 to 50 VDC																					
Capacitance Range	0.1 to 100 µF																					
Capacitance Tolerance	±20% (120Hz, +20°C)																					
Leakage Current(+20°C, max)	$I \leq 0.05 CV$ or $10 (\mu A)$ After 2 minutes, whichever is greater measured with rated working voltage applied.																					
Dissipation Factor (tan δ, at 20°C, 120Hz)	<table border="1"> <thead> <tr> <th>Working Voltage (VDC)</th> <th>6.3</th> <th>10</th> <th>16</th> <th>25</th> <th>35</th> <th>50</th> </tr> </thead> <tbody> <tr> <td>D.F. (%)max</td> <td>24</td> <td>20</td> <td>16</td> <td>16</td> <td>14</td> <td>12</td> </tr> </tbody> </table>	Working Voltage (VDC)	6.3	10	16	25	35	50	D.F. (%)max	24	20	16	16	14	12							
Working Voltage (VDC)	6.3	10	16	25	35	50																
D.F. (%)max	24	20	16	16	14	12																
Low Temperature Characteristics (at 120Hz)	Impedance ratio max <table border="1"> <thead> <tr> <th>Rated voltage(VDC)</th> <th>6.3</th> <th>10</th> <th>16</th> <th>25</th> <th>35</th> <th>50</th> </tr> </thead> <tbody> <tr> <td>Z-25°C / Z+20°C</td> <td>4</td> <td>3</td> <td>2</td> <td>2</td> <td>2</td> <td>2</td> </tr> <tr> <td>Z-40°C / Z+20°C</td> <td>8</td> <td>6</td> <td>4</td> <td>4</td> <td>3</td> <td>3</td> </tr> </tbody> </table>	Rated voltage(VDC)	6.3	10	16	25	35	50	Z-25°C / Z+20°C	4	3	2	2	2	2	Z-40°C / Z+20°C	8	6	4	4	3	3
Rated voltage(VDC)	6.3	10	16	25	35	50																
Z-25°C / Z+20°C	4	3	2	2	2	2																
Z-40°C / Z+20°C	8	6	4	4	3	3																
Endurance	Test conditions Duration time :1000 Hrs Ambient temperature :+105°C Applied voltage :Rated DC working voltage to each polarity for 500 Hrs After test requirement at +20°C Capacitance change :≤ ±20% of the initial measured value Dissipation factor :≤ 200% of the initial specified value Leakage current :≤ The initial specified value																					
Shelf Life	Test conditions Duration time :1000 Hrs Ambient temperature :+105°C Applied voltage :None After test requirement at +20°C : Same limits as Endurance. Pre-treatment for measurements shall be conducted after application of DC working voltage for 30 minutes.																					

Multiplier for Ripple Current vs. Frequency

CAP(µF)\Frequency(Hz)	50(60)	120	400	1K	10K	50K-100K
CAP ≤ 10	0.8	1	1.30	1.45	1.65	1.70
10 < CAP ≤ 220	0.8	1	1.23	1.36	1.48	1.53

Diagram of Dimensions:(unit:mm)

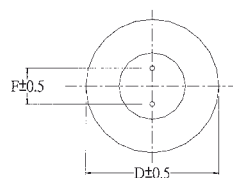
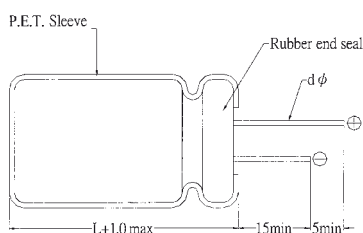

D φ	4	5	6.3	8
F	1.5±0.5	2.0±0.5	2.5±0.5	3.5±0.5
d φ	0.45		0.5	

Case Size

φ DxDL(mm)

WV Cap(μF)	6.3		10		16		25		35		50	
	Size	Ripple	Size	Ripple	Size	Ripple	Size	Ripple	Size	Ripple	Size	Ripple
0.1											4x7	1.0
0.22											4x7	2.3
0.33											4x7	3.5
0.47											4x7	5.0
1											4x7	10
2.2									4x7	13	5x7	16
3.3							4x7	14	5x7	18	5x7	20
4.7					4x7	18	5x7	19	5x7	22	6.3x7	27
10	4x7	23	4x7	24	5x7	30	6.3x7	35	6.3x7	37	8x7	44
22	5x7	30	5x7	38	6.3x7	51	6.3x7	53	8x7	58		
33	5x7	40	6.3x7	52	6.3x7	58	8x7	70	8x7	70		
47	6.3x7	56	8x7	65	8x7	73	8x7	80				
100	8x7	92	8x7	105	8x7	120						

Ripple Current (mA, rms) at 105°C 120Hz

SZ Series 7-9 mm Low Impedance

Features

- ◆ Operating temperature range -55 to +105°C
- ◆ 105°C, 1000 hours assured
- ◆ RoHS Compliant

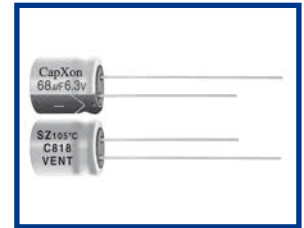

Specifications

Item	Performance Characteristics																		
Operating Temperature Range	-55 to +105°C																		
Rated Voltage Range	6.3 to 35 VDC																		
Capacitance Range	6.8 to 330 µF																		
Capacitance Tolerance	±20% (120Hz, +20°C)																		
Leakage Current(+20°C, max)	I ≤ 0.01 CV or 3 (µA) After 2 minutes, whichever is greater measured with rate working voltage applied.																		
Dissipation Factor (tan δ, at 20°C, 120Hz)	<table border="1"> <tr> <td>Working Voltage (VDC)</td> <td>6.3</td> <td>10</td> <td>16</td> <td>25</td> <td>35</td> </tr> <tr> <td>D.F. (%)max</td> <td>18</td> <td>16</td> <td>14</td> <td>12</td> <td>12</td> </tr> </table>	Working Voltage (VDC)	6.3	10	16	25	35	D.F. (%)max	18	16	14	12	12						
Working Voltage (VDC)	6.3	10	16	25	35														
D.F. (%)max	18	16	14	12	12														
Low Temperature Characteristics (at 120Hz)	Impedance ratio max <table border="1"> <tr> <td>Rated voltage(VDC)</td> <td>6.3</td> <td>10</td> <td>16</td> <td>25</td> <td>35</td> </tr> <tr> <td>Z-25°C/Z+20°C</td> <td>2</td> <td>2</td> <td>2</td> <td>2</td> <td>2</td> </tr> <tr> <td>Z-55°C/Z+20°C</td> <td>3</td> <td>3</td> <td>3</td> <td>3</td> <td>3</td> </tr> </table>	Rated voltage(VDC)	6.3	10	16	25	35	Z-25°C/Z+20°C	2	2	2	2	2	Z-55°C/Z+20°C	3	3	3	3	3
Rated voltage(VDC)	6.3	10	16	25	35														
Z-25°C/Z+20°C	2	2	2	2	2														
Z-55°C/Z+20°C	3	3	3	3	3														
Endurance	Test conditions Duration time :1000 Hrs Ambient temperature :+105°C Applied voltage :Rated DC working voltage After test requirement at +20°C Capacitance change :≤ ±20% of the initial measured value Dissipation factor :≤ 200% of the initial specified value Leakage current :≤ The initial specified value																		
Shelf Life	Test conditions Duration time :1000 Hrs Ambient temperature :+105°C Applied voltage :None After test requirement at +20°C : Same limits as Endurance. Pre-treatment for measurements shall be conducted after application of DC working voltage for 30 minutes.																		

Multiplier for Ripple Current vs. Frequency

CAP(µF)\Frequency(Hz)	50(60)	120	400	1K	10K	50K-100K
CAP ≤ 10	0.47	0.59	0.76	0.85	0.91	1
10 < CAP ≤ 220	0.52	0.65	0.80	0.89	0.97	1
100 < CAP	0.58	0.72	0.84	0.90	0.98	1

Diagram of Dimensions:(unit:mm)

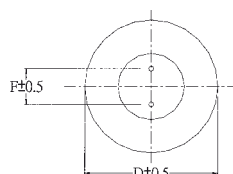
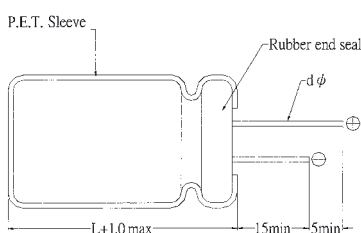

D φ	4	5	6.3	8
F	1.5±0.5	2.0±0.5	2.5±0.5	3.5±0.5
d φ	0.45		0.5	

Case Size

φ DxL(mm)

WV Cap(μF)	6.3			10			16		
	Size	Ripple	Impedance	Size	Ripple	Impedance	Size	Ripple	Impedance
22				4x7	70	3.30	5x7	115	1.7
33	5x7	110	1.70	5x7	110	1.70	6.3x7	160	0.8
47	5x7	110	1.70	5x7	160	0.80	6.3x7	160	0.8
68	6.3x7	160	0.80	6.3x7	160	0.80	8x7	200	0.5
100	6.3x7	160	0.80	6.3x7	200	0.50	8x7	200	0.45
120	6.3x7	165	0.70	6.3x7	205	0.48	8x7	350	0.35
150	6.3x7	178	0.60	8x7	230	0.45	8x7	370	0.32
180	8x7	190	0.58	8x7	250	0.45	8x7	400	0.30
220	8x7	200	0.50	8x7	280	0.35	8x7	430	0.26
330	8x7	350	0.35	8x9	320	0.30	8x9	500	0.22
470	8x9	400	0.30	10x9	430	0.22			

WV Cap(μF)	25			35		
	Size	Ripple	Impedance	Size	Ripple	Impedance
6.8				4x7	70	3.3
10	4x7	70	3.0	5x7	110	1.7
22	5x7	110	1.70	6.3x7	160	0.8
33	6.3x7	160	0.80	8x7	200	0.5
47	8x7	200	0.50	8x7	245	0.45
68	8x7	200	0.50	8x7	280	0.42
100	8x7	250	0.35			
150	8x7	340	0.40			
180	8x9	450	0.25			
220	8x9	600	0.22			
330	10x9	750	0.15			

Ripple Current (mA, rms) at 105°C 100KHz
 Max Impedance (Ω) at 20°C 100 KHz

SY Series 7mm Low Impedance Long Life

Features

- ◆ Operating temperature -55~105°C.
- ◆ 105°C 2000Hours assured.
- ◆ RoHS Compliant

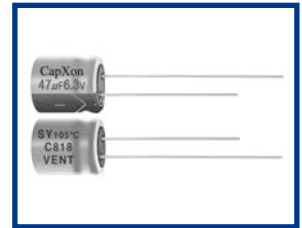

Specifications

Item	Performance Characteristics																					
Operating Temperature Range	-55 to +105°C																					
Rated Voltage Range	6.3 to 50 VDC																					
Capacitance Range	1~330 µ F																					
Capacitance Tolerance	±20%(120Hz,+20°C)																					
Leakage Current (+20°C,max.)	$I \leq 0.01 CV$ or $3 (\mu A)$ After 2 minute with rated working voltage applied.																					
Dissipation Factor ($\tan \delta$ · at 20°C · 120Hz)	<table border="1"> <tr> <td>Working Voltage(VDC)</td> <td>6.3</td> <td>10</td> <td>16</td> <td>25</td> <td>35</td> <td>50</td> </tr> <tr> <td>D.F.(%)max.</td> <td>18</td> <td>16</td> <td>14</td> <td>12</td> <td>12</td> <td>10</td> </tr> </table>	Working Voltage(VDC)	6.3	10	16	25	35	50	D.F.(%)max.	18	16	14	12	12	10							
	Working Voltage(VDC)	6.3	10	16	25	35	50															
D.F.(%)max.	18	16	14	12	12	10																
Low Temperature Characteristics (at 120Hz)	Impedance ratio max																					
	<table border="1"> <tr> <td>Working Voltage(VDC)</td> <td>6.3</td> <td>10</td> <td>16</td> <td>25</td> <td>35</td> <td>50</td> </tr> <tr> <td>Z-25°C / Z+20°C</td> <td>2</td> <td>2</td> <td>2</td> <td>2</td> <td>2</td> <td>2</td> </tr> <tr> <td>Z-55°C / Z+20°C</td> <td>3</td> <td>3</td> <td>3</td> <td>3</td> <td>3</td> <td>3</td> </tr> </table>	Working Voltage(VDC)	6.3	10	16	25	35	50	Z-25°C / Z+20°C	2	2	2	2	2	2	Z-55°C / Z+20°C	3	3	3	3	3	3
	Working Voltage(VDC)	6.3	10	16	25	35	50															
Z-25°C / Z+20°C	2	2	2	2	2	2																
Z-55°C / Z+20°C	3	3	3	3	3	3																
Endurance	Test condition Duration time :2000Hrs Ambient temperature :+105°C Applied voltage :Rated DC working voltage After test requirement at +20°C Capacitance change : within ±20% of the initial measured value Dissipation factor : ≤200% of the initial specified value Leakage current : ≤The initial specified value																					
Shelf Life	Test condition Duration time :1000Hrs Ambient temperature :+105°C Applied voltage :None After test requirement at +20°C:Same limits as Endurance. Pre-treatment for measurements shall be conducted after application of DC working voltage for 30 minutes.																					

Multiplier for Ripple Current vs. Frequency

CAP(µ F)\Frequency(Hz)	50(60)	120	400	1K	10K	50-100K
$1 \leq CAP \leq 10$	0.47	0.59	0.76	0.85	0.97	1
$10 < CAP \leq 100$	0.52	0.65	0.80	0.89	0.97	1
$100 < CAP$	0.58	0.72	0.84	0.90	0.98	1

Diagram of Dimensions:(unit:mm)

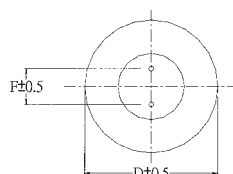
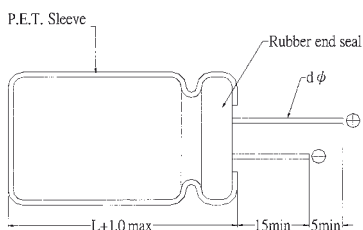

Dφ	4	5	6.3	8
F	1.5±0.5	2.0±0.5	2.5±0.5	3.5±0.5
dφ	0.45		0.5	

Case Size

φ DxL(mm)

Cap(μF) \ WV	6.3			10			16		
	Size	Ripple	Impedance	Size	Ripple	Impedance	Size	Ripple	Impedance
10							4X7	60	3.5
15							4X7	75	3.0
22				4X7	63	3.63	5X7	90	2
33	5X7	90	1.95	5X7	95	1.9	6.3X7	120	1.4
47	6.3X7	99	1.87	5X7	120	1.3	6.3X7	140	0.9
68	6.3X7	125	1	6.3X7	144	0.88	8X7	160	0.65
100	6.3X7	144	0.82	6.3X7	180	0.55	8X7	180	0.49
120	6.3X7	148	0.77	6.3X7	185	0.52	8X7	315	0.93
150	6.3X7	160	0.66	8X7	207	0.5	8X7	333	0.95
180	8X7	171	0.64	8X7	225	0.49	8X7	360	0.33
220	8X7	180	0.55	8X7	252	0.4	8X7	387	0.29
330	8X7	315	0.39						

Cap(μF) \ WV	25			35			50		
	Size	Ripple	Impedance	Size	Ripple	Impedance	Size	Ripple	Impedance
1							4X7	60	3.5
2.2							4X7	60	3.5
3.3							4X7	60	3.5
4.7							4X7	60	3.5
6.8				4X7	63	3.63	5X7	80	2.2
10	4X7	60	3.5	5X7	99	3.2	6.3X7	135	0.92
22	5X7	99	1.87	6.3X7	140	0.9			
33	6.3X7	144	0.88	8X7	180	0.55			
47	8X7	160	0.7	8X7	220	0.5			
68	8X7	180	0.55						
100	8X7	225	0.39						
150	8X7	306	0.35						

Ripple Current(mA,rms) at 105°C 100KHz
 Max Impedance (Ω) at 20°C 100KHz

Radial

GS(GR) Series General Purpose 85°C

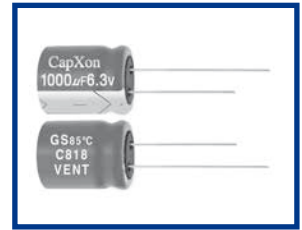

Features

- ◆ Wide CV value range.
- ◆ Endurance 2000 hrs at 85°C.
- ◆ Safety vent construction design.
- ◆ RoHS Compliant

Specifications

Item	Performance Characteristics						
Operating Temperature Range	-40 to +85°C	-25 to +85°C					
Rated Voltage Range	6.3 to 100 VDC	160 to 450 VDC					
Capacitance Range	0.1 to 33000 µF	0.47 to 470 µF					
Capacitance Tolerance	±20% (120Hz, +20°C)						
Leakage Current (+20°C,max.)	I ≤ 0.01 CV or 3 (µA)						
	I ≤ 0.03 CV (µA)						
After 1 minute whichever is greater measures with rated working voltage applied.							
Dissipation Factor (tan δ , at 20°C , 120Hz)	Working Voltage(VDC)	6.3 10 16 25 35 50 63 100					
	D.F. (%)max.	22 19 16 14 12 10 9 8					
	Working Voltage(VDC)	160 200 250 350 400 450					
	D.F. (%)max.	12 12 12 15 15 17					
For capacitance > 1000 µF, add 2% per another 1000 µF.							
Low Temperature Characteristics (at 120Hz)	Impedance ratio max						
	Working Voltage(VDC)	6.3 10 16 25 35 50 63 100					
	Z-25°C / Z+20°C	4 3 2 2 2 2 2 2					
	Z-40°C / Z+20°C	8 6 4 3 3 3 3 3					
	Working Voltage(VDC)	160 200 250 350 400 450					
	Z-25°C / Z+20°C	2 2 3 5 15 15					
For Capacitance > 1000 µF, add 0.5 per another 1000 µF for -25°C / +20°C add 1 per another 1000 µF for -40°C / +20°C							
Endurance	Test conditions						
	Duration time	:2000Hrs					
	Ambient temperature	:+85°C					
	Applied voltage	:Rated DC working voltage					
	After test requirement at +20°C						
	Capacitance change	:≤ ±20% of the initial measured value					
	Dissipation factor	:≤ 200% of the initial specified value					
Leakage Current	:≤ The initial specified value						
Shelf Life	Test conditions						
	Duration time	:1000Hrs					
	Ambient temperature	:+85°C					
	Applied voltage	:None					
	After test requirement at +20°C: Same limits as Endurance. Pre-treatment for measurements shall be conducted after application of DC working voltage for 30 minutes.						

Multiplier for Ripple Current vs. Frequency

CAP (µF) \ Frequency(Hz)	50(60)	120	400	1K	10K	50K-100K
CAP ≤ 10	0.8	1	1.30	1.45	1.65	1.70
10 < CAP ≤ 100	0.8	1	1.23	1.36	1.48	1.53
100 < CAP ≤ 1000	0.8	1	1.16	1.25	1.35	1.38
1000 < CAP	0.8	1	1.11	1.17	1.25	1.28

Diagram of Dimensions:(unit:mm)

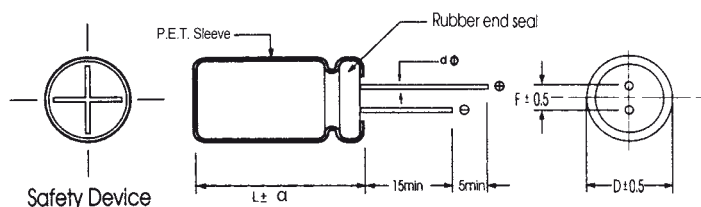

D φ	5	6.3	8	10	13	16	18	22
F	2.0	2.5	3.5	5.0	5.0	7.5	7.5	10
d φ	0.5		L < 20 0.5	L ≥ 20 0.6	0.6		0.8	
α	D < 18	D = 18		D > 18				
		L < 35.5	L ≥ 35.5			1.5	1.5	2.0

Case Size

φ DxL(mm)

WV Cap(μF)	6.3		10		16		25		35	
	Size	Ripple	Size	Ripple	Size	Ripple	Size	Ripple	Size	Ripple
4.7							5x11	34	5x11	44
10					5x11	44	5x11	50	5x11	66
22			5x11	66	5x11	83	5x11	94	5x11	108
33	5x11	72	5x11	88	5x11	84	5x11	105	5x11	121
47	5x11	88	5x11	105	5x11	132	5x11	132	5x11	143
									6.3x11	154
68	5x11	110	5x11	132	5x11	149	6.3x11	176	6.3x11	198
100	5x11	143	5x11	198	5x11	176	6.3x11	209	6.3x11	231
					6.3x11	204			8x11.5	253
120	5x11	165	5x11	209	6.3x11	231	6.3x11	253	8x11.5	275
150	5x11	198	5x11	231	6.3x11	253	6.3x11	275	8x11.5	308
180	5x11	220	6.3x11	253	6.3x11	275	6.3x11	280	8x11.5	352
							8x11.5	319		
220	5x11	242	6.3x11	294	6.3x11	308	6.3x11	310	8x11.5	385
	6.3x11	264			8x11.5	352	8x11.5	363	10x12.5	407
330	6.3x11	330	6.3x11	363	8x11.5	407	8x11.5	451	10x12.5	528
							10x12.5	484	10x16	539
470	6.3x11	385	6.3x11	418	8x11.5	517	8x11.5	561	10x16	693
	8x11.5	418	8x11.5	440			10x12.5	594	10x20	748
560	8x11.5	473	8x11.5	506	10x12.5	572	10x16	693	10x20	847
680	8x11.5	539	8x11.5	572	8x16	640	10x16	792	10x20	891
					10x12.5	682	10x20	825		
820	8x11.5	605	10x12.5	671	10x16	803	10x20	891	13x20	1045
	8x11.5	649	8x16	725	10x16	869	10x20	1050	13x20	1265
1000	10x12.5	715	8x20	803						
			10x12.5	726						
1200	10x12.5	814	10x16	902	10x16	979	13x20	1155	13x20	1375
1500	10x16	935	10x16	1001	10x20	1100	13x20	1353	13x25	1570
1800	10x16	1035	10x20	1089	13x20	1298	13x20	1496	16x25	1749
2200	10x20	1135	10x20	1210	13x20	1485	13x25	1705	16x25	1870
			13x20	1330					16x31.5	1980
2700	10x20	1353	13x20	1419	13x20	1716	16x25	1804	16x31.5	2178
3300	10x20	1430	13x20	1540	13x20	1750	16x25	1870	16x31.5	2365
	13x20	1485			13x25	1870	16x31.5	2145	16x35.5	2552
3900	13x20	1529	13x20	1760	16x25	2002	16x31.5	2343	18x31.5	2640
4700	13x20	1672	13x25	1980	16x25	2310	16x31.5	2640	18x35.5	2860
	13x25	1870								
5600	13x25	2002	16x25	2189	16x31.5	2453	18x31.5	2816	18x41	2915
6800	16x25	2310	16x25	2475	16x31.5	2805	18x35.5	2970	22x41	3630
8200	16x25	2332	16x31.5	2541	16x35.5	2893	18x35.5	2981		
10000	16x31.5	2530	16x35.5	2640	18x35.5	2970	22x41	3960		
			18x35.5	2915	18x41	3190				
12000	16x35.5	2783	18x35.5	3025	18x35.5	3058				
					18x41	3212				
15000	16x35.5	2948	18x35.5	3310	22x41	3905				
	18x35.5	3168								
18000	18x35.5	3300	18x41	3410						
22000	18x41	3575	22x41	4092						
33000	22x41	4290	22x51	4620						

Ripple Current (mA, rms) at 85°C 120Hz

φ DxL(mm)

WV Cap(μF)	50		63		100		160		200	
	Size	Ripple	Size	Ripple	Size	Ripple	Size	Ripple	Size	Ripple
0.1	5x11	3.3	5x11	4	5x11	4.5				
0.22	5x11	3.3	5x11	4	5x11	6				
0.33	5x11	5.5	5x11	6	5x11	10				
0.47	5x11	7.5	5x11	8	5x11	14	5x11	12	5x11	12
1	5x11	17	5x11	17	5x11	27	5x11	17	6.3x11	17
2.2	5x11	28	5x11	31	5x11	40	6.3x11	30	6.3x11	30
3.3	5x11	39	5x11	39	5x11	48	6.3x11	36	6.3x11	36
4.7	5x11	46	5x11	50	5x11	58	6.3x11	40	8x11.5	51
							8x11.5	48		
10	5x11	72	5x11	77	5x11	85	8x11.5	80	10x12.5	83
					6.3x11	92			10x16	88
22	5x11	110	6.3x11	127	6.3x11	157	10x12.5	135	10x20	135
					8x11.5	164				
33	5x11	132	6.3x11	149	8x11.5	206	10x16	180	13x20	205
	6.3x11	138	8x11.5	160	10x12.5	218				
47	6.3x11	165	6.3x11	198	10x12.5	278	10x20	230	13x20	250
			8x11.5	209	10x16	303			13x25	280
68	8x11.5	220	8x11.5	253	10x16	387	13x20	360	13x25	370
100	8x11.5	286	10x12.5	330	10x20	472	13x25	430	16x25	460
120	8x11.5	319	10x16	396	10x20	532	16x25	530	16x25	550
150	10x12.5	363	10x16	462	13x20	629	16x25	560	16x31.5	580
180	10x12.5	418	10x16	528	13x20	667	16x31.5	650	16x31.5	660
220	10x12.5	468	10x16	550	13x25	740	16x31.5	850	18x35.5	750
	10x16	484	10x20	583	16x25	872	16x35.5	890	18x35.5	800
330	10x16	649	10x20	759	13x25	920	18x31.5	890	18x35.5	940
	10x20	671	13x20	781	16x25	1040	18x35.5	920	18x41	1000
470	10x20	828	13x20	968	16x25	1210	18x35.5	1180	18x41	1330
	13x20	858	13x25	1023	16x31.5	1330	18x41	1250		
560	13x20	902	13x25	1056	16x35.5	1465	18x45	1320		
			16x25	1089						
680	13x20	1056	16x25	1265	16x35.5	1634				
820	13x25	1287	16x25	1430	18x35.5	1815				
1000	13x25	1485	16x25	1540	18x41	1940				
	16x25	1540	16x31.5	1705						
1200	16x25	1617	16x31.5	1837						
1500	16x31.5	1848	16x35.5	2090						
1800	16x31.5	2112	16x35.5	2255						
2200	16x35.5	2310	18x35.5	2475						
			18x41	2750						
2700	18x31.5	2420	22x41	2860						
3300	18x35.5	2750	22x41	3080						
3900	18x41	2871								
4700	22x41	3355								

Ripple Current (mA, rms) at 85°C 120Hz

φ DxDL(mm)

WV Cap(μF)	250		350		400		450	
	Size	Ripple	Size	Ripple	Size	Ripple	Size	Ripple
0.47	5x11	12	6.3x11	15	6.3x11	12	6.3x11	12
					8x11.5	12		
1	6.3x11	17	6.3x11	22	6.3x11	20	8x11.5	22
					8x11.5	22		
2.2	6.3x11	20	8x11.5	30	8x11.5	32	8x11.5	32
	8x11.5	33	10x12.5	32	10x12.5	35	10x12.5	35
3.3	8x11.5	38	8x11.5	46	8x11.5	45	8x11.5	35
							10x12.5	37
4.7	10x12.5	43	10x12.5	51	10x12.5	53	10x16	40
	8x11.5	48	8x11.5	55	8x11.5	55	10x12.5	50
10			10x12.5	63	10x12.5	66		
	10x12.5	51	10x16	66	10x16	70	10x16	56
22	10x12.5	90	10x16	115	10x16	100	10x20	90
					10x20	115	13x20	105
33			10x20	125	13x20	120	13x25	110
	10x20	135	13x20	180	13x20	190	13x20	140
47							13x25	150
	13x20	165			13x25	200	16x25	165
68	13x20	210	13x20	225	13x25	230	16x25	190
	13x25	220	13x25	250	16x25	250	16x31.5	210
100	13x20	240	16x25	290	16x25	270	16x31.5	260
	13x25	260						
150	13x25	260			16x31.5	290	16x35.5	280
	13x25	340	16x31.5	400	16x35.5	410	18x31.5	370
180	16x25	390			18x25	380	18x35.5	390
					18x31.5	420		
120	16x25	410	18x31.5	430	18x31.5	440	18x41	420
	16x31.5	450			18x35.5	450		
120	16x31.5	560	18x35.5	550	18x41	520	18x45	510
150	18x31.5	600	18x41	570				
180	18x31.5	680						

Ripple Current (mA, rms) at 85°C 120Hz

GW Series 9-21 mm height Low Profile 85°C

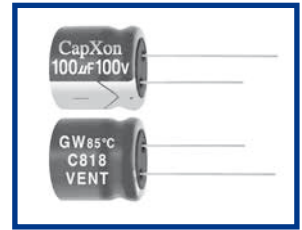

Features

- ◆ Miniaturized low profile.
- ◆ Height 9mm-25mm max.
- ◆ Safety vent construction design.
- ◆ RoHS Compliant

Specifications

Item	Performance Characteristics																																		
Operating Temperature Range	-40 to +85°C	-25 to +85°C																																	
Rated Voltage Range	6.3 to 100 VDC	160 to 450 VDC																																	
Capacitance Range	2.2 to 10000 µF	2.2 to 220 µF																																	
Capacitance Tolerance	±20% (120Hz, +20°C)																																		
Leakage Current (+20°C, max.)	I ≤ 0.01 CV or 3 (µA) After 2 minutes whichever is greater measured with rated working voltage applied.	I ≤ 0.04 CV+100 (µA) After 2 minutes with rated working voltage applied.																																	
Dissipation Factor (tan δ, at 20°C, 120Hz)	<table border="1"> <tr> <th>Working Voltage(VDC)</th> <td>6.3</td> <td>10</td> <td>16</td> <td>25</td> <td>35</td> <td>50</td> <td>63</td> <td>100</td> </tr> <tr> <th>D.F. (%)max.</th> <td>24</td> <td>22</td> <td>20</td> <td>14</td> <td>12</td> <td>12</td> <td>10</td> <td>10</td> </tr> </table>								Working Voltage(VDC)	6.3	10	16	25	35	50	63	100	D.F. (%)max.	24	22	20	14	12	12	10	10									
	Working Voltage(VDC)	6.3	10	16	25	35	50	63	100																										
D.F. (%)max.	24	22	20	14	12	12	10	10																											
	<table border="1"> <tr> <th>Working Voltage(VDC)</th> <td>160</td> <td>200</td> <td>250</td> <td>350</td> <td>400</td> <td>450</td> <td colspan="2"></td> </tr> <tr> <th>D.F. (%)max.</th> <td>15</td> <td>15</td> <td>15</td> <td>20</td> <td>20</td> <td>20</td> <td colspan="2"></td> </tr> </table> <p>For capacitance > 1000 µF, add 2% per another 1000 µF.</p>								Working Voltage(VDC)	160	200	250	350	400	450			D.F. (%)max.	15	15	15	20	20	20											
Working Voltage(VDC)	160	200	250	350	400	450																													
D.F. (%)max.	15	15	15	20	20	20																													
Low Temperature Characteristics (at 120Hz)	Impedance ratio max																																		
	<table border="1"> <tr> <th>Working Voltage(VDC)</th> <td>6.3</td> <td>10</td> <td>16</td> <td>25</td> <td>35</td> <td>50</td> <td>63</td> <td>100</td> </tr> <tr> <th>Z-25°C / Z+20°C</th> <td>6</td> <td>4</td> <td>4</td> <td>3</td> <td>2</td> <td>2</td> <td>2</td> <td>2</td> </tr> <tr> <th>Z-40°C / Z+20°C</th> <td>12</td> <td>10</td> <td>8</td> <td>6</td> <td>4</td> <td>3</td> <td>3</td> <td>3</td> </tr> </table>									Working Voltage(VDC)	6.3	10	16	25	35	50	63	100	Z-25°C / Z+20°C	6	4	4	3	2	2	2	2	Z-40°C / Z+20°C	12	10	8	6	4	3	3
Working Voltage(VDC)	6.3	10	16	25	35	50	63	100																											
Z-25°C / Z+20°C	6	4	4	3	2	2	2	2																											
Z-40°C / Z+20°C	12	10	8	6	4	3	3	3																											
	<table border="1"> <tr> <th>Working Voltage(VDC)</th> <td>160</td> <td>200</td> <td>250</td> <td>350</td> <td>400</td> <td>450</td> <td colspan="2"></td> </tr> <tr> <th>Z-25°C / Z+20°C</th> <td>2</td> <td>2</td> <td>3</td> <td>5</td> <td>5</td> <td>7</td> <td colspan="2"></td> </tr> </table> <p>For Capacitance > 1000 µF, add 0.5 per another 1000 µF for -25°C / +20°C add 1 per another 1000 µF for -40°C / +20°C</p>									Working Voltage(VDC)	160	200	250	350	400	450			Z-25°C / Z+20°C	2	2	3	5	5	7										
Working Voltage(VDC)	160	200	250	350	400	450																													
Z-25°C / Z+20°C	2	2	3	5	5	7																													
Endurance	Test conditions Duration time :2000Hrs Ambient temperature :+85°C Applied voltage :Rated DC working voltage After test requirement at +20°C Capacitance change :≤ ±20% of the initial measured value Dissipation factor :≤ 200% of the initial specified value Leakage current :≤ The initial specified value																																		
Shelf Life	Test conditions Duration time :1000Hrs Ambient temperature :+85°C Applied voltage :None After test requirement at +20°C: Same limits as Endurance. Pre-treatment for measurements shall be conducted after application of DC working voltage for 30 minutes.																																		

Multiplier for Ripple Current vs. Frequency

CAP (µF) \ Frequency(Hz)	50(60)	120	400	1K	≥10K
2.2~47 µF	0.8	1	1.20	1.30	1.50
100~1000 µF	0.8	1	1.10	1.15	1.20
2200~10000 µF	0.8	1	1.05	1.10	1.15

Diagram of Dimensions:(unit:mm)

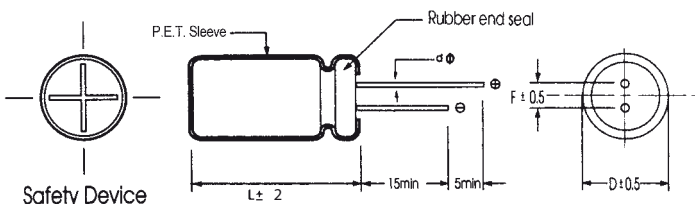

D φ	5	6.3	8	10	13	16	18
F	2.0	2.5	3.5	5.0	5.0	7.5	7.5
d φ	0.5		0.6		0.8		

Case Size

WV Cap(μF)		6.3		10		16		25		35		50		63		φ DxL(mm)
		Size	Ripple	Size	Ripple	Size	Ripple	Size	Ripple	Size	Ripple	Size	Ripple	Size	Ripple	
2.2												5x9	23	5x9	26	
3.3												5x9	30	5x9	31	
4.7												5x9	35	5x9	36	
6.8												5x9	50	5x9	54	
10												5x9	64	6.3x9	68	
22												5x9	86	6.3x9	102	
33										5x9	95	6.3x9	115	8x9	135	
47								5x9	105	6.3x9	120	6.3x9	135	10x9	170	
68						5x9	120	6.3x9	130	6.3x9	140	8x9	155	10x9	200	
100	5x9	128	5x9	134	6.3x9	160	6.3x9	175	8x9	220	10x9	230	10x16	340		
150	5x9	150	6.3x9	180	6.3x9	260	8x9	280	8x9	300	10x9	320	13x13	384		
220	6.3x9	180	6.3x9	210	8x9	290	8x9	310	10x9	335	10x16	380	13x13	490		
											13x13	400				
330	6.3x9	247	8x9	300	8x9	340	10x9	400	10x12.5	475	13x13	530	16x16	610		
						10x9	355				13x16	550				
470	8x9	360	8x9	360	10x9	410	10x12.5	525	13x13	590	13x16	720	16x16	840		
									13x16	650	16x16	750				
680	10x9	420	10x9	540	10x12.5	560	10x16	700	13x16	750	16x16	805	16x21	950		
							13x13	730								
1000	10x9	530	10x12.5	625	13x13	750	13x16	1050	16x16	1230	16x21	1450				
2200	13x16	1050	13x16	1080	16x16	1150	16x21	1350	18x21	1600						
							18x16	1300								
3300	16x16	1200	16x16	1350	16x16	1500	18x21	1600								
						18x16	1460									
4700	16x16	1500	16x21	1550	18x21	1650										
6800	16x21	1550	18x21	1850												
	18x16	1600														
10000	18x21	2000														

WV Cap(μF)		100		160		200		250		350		400		450	
		Size	Ripple	Size	Ripple	Size	Ripple	Size	Ripple	Size	Ripple	Size	Ripple	Size	Ripple
1.5														8x9	30
2.2	5x9	27										8x9	38	10x9	46
3.3	5x9	33								8x9	45	10x9	50	10x9	55
4.7	6.3x9	41	8x9	50	8x9	55	8x9	60	10x9	78	10x9	90	10x12.5	105	
								10x9	52						
6.8	6.3x9	59	8x9	75	8x9	78	10x9	82	10x16	105	13x16	125	13x16	135	
10	8x9	78	10x9	87	10x9	92	10x9	98	13x16	145	13x16	160	16x16	200	
								10x16	120			16x16	190		
22	8x9	107	10x16	135	13x16	150	13x16	165	16x16	190	16x21	230	16x21	250	
								16x16	210			18x16	225		
33	10x9	155	13x16	175	13x16	190	16x16	230	16x21	270	18x21	300	18x21	320	
						16x16	200	18x16	260	18x16	335				
47	10x16	220	13x16	285	16x16	320	16x21	340	18x21	360	18x21	385			
			16x16	325			18x16	380							
68	10x16	261	16x16	340	16x16	360	16x21	420							
	13x13	270			18x16	390									
100	13x13	410	16x21	515	16x21	575	18x21	610							
150	16x16	579	18x21	620											
220	16x21	668													
330	16x25	864													
470															

Ripple Current (mA, rms) at 85°C 120Hz

Radial

KM Series Standard 105°C

Features

- ◆ Used in communication equipments, switching power supply, etc.
- ◆ Safety vent construction design.
- ◆ RoHS Compliant

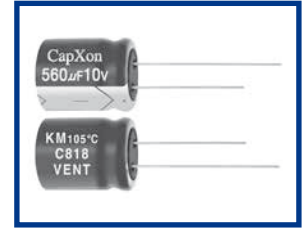

Specifications

Item	Performance Characteristics																																	
Operating Temperature Range	-40 to +105°C	-25 to +105°C																																
Rated Voltage Range	6.3 to 100 VDC	160 to 450 VDC																																
Capacitance Range	0.1 to 22000 µF	0.47 to 470 µF																																
Capacitance Tolerance	±20% (120Hz, +20°C)																																	
Leakage Current (+20°C, max.)	I ≤ 0.01 CV or 3 (µA) After 1 minute whichever is greater measured with rated working voltage applied.	I ≤ 0.03 CV (µA) After 1 minute with rated working voltage applied.																																
Dissipation Factor (tan δ, at 20°C, 120Hz)	<table border="1"> <tr> <td>Working Voltage(VDC)</td> <td>6.3</td> <td>10</td> <td>16</td> <td>25</td> <td>35</td> <td>50</td> <td>63</td> <td>100</td> </tr> <tr> <td>D.F. (%)max.</td> <td>22</td> <td>17</td> <td>16</td> <td>14</td> <td>12</td> <td>10</td> <td>9</td> <td>8</td> </tr> </table>								Working Voltage(VDC)	6.3	10	16	25	35	50	63	100	D.F. (%)max.	22	17	16	14	12	10	9	8								
	Working Voltage(VDC)	6.3	10	16	25	35	50	63	100																									
D.F. (%)max.	22	17	16	14	12	10	9	8																										
		<table border="1"> <tr> <td>Working Voltage(VDC)</td> <td>160</td> <td>200</td> <td>250</td> <td>350</td> <td>400</td> <td>420</td> <td>450</td> </tr> <tr> <td>D.F. (%)max.</td> <td>12</td> <td>12</td> <td>12</td> <td>15</td> <td>15</td> <td>17</td> <td>17</td> </tr> </table>						Working Voltage(VDC)	160	200	250	350	400	420	450	D.F. (%)max.	12	12	12	15	15	17	17	For capacitance > 1000 µF, add 2% per another 1000 µF.										
Working Voltage(VDC)	160	200	250	350	400	420	450																											
D.F. (%)max.	12	12	12	15	15	17	17																											
Low Temperature Characteristics (at 120Hz)	Impedance ratio max																																	
	<table border="1"> <tr> <td>Working Voltage(VDC)</td> <td>6.3</td> <td>10</td> <td>16</td> <td>25</td> <td>35</td> <td>50</td> <td>63</td> <td>100</td> </tr> <tr> <td>Z-25°C/Z+20°C</td> <td>4</td> <td>3</td> <td>2</td> <td>2</td> <td>2</td> <td>2</td> <td>2</td> <td>2</td> </tr> <tr> <td>Z-40°C/Z+20°C</td> <td>8</td> <td>6</td> <td>4</td> <td>3</td> <td>3</td> <td>3</td> <td>3</td> <td>3</td> </tr> </table>								Working Voltage(VDC)	6.3	10	16	25	35	50	63	100	Z-25°C/Z+20°C	4	3	2	2	2	2	2	2	Z-40°C/Z+20°C	8	6	4	3	3	3	3
Working Voltage(VDC)	6.3	10	16	25	35	50	63	100																										
Z-25°C/Z+20°C	4	3	2	2	2	2	2	2																										
Z-40°C/Z+20°C	8	6	4	3	3	3	3	3																										
		<table border="1"> <tr> <td>Working Voltage(VDC)</td> <td>160</td> <td>200</td> <td>250</td> <td>350</td> <td>400</td> <td>420</td> <td>450</td> </tr> <tr> <td>Z-25°C/Z+20°C</td> <td>2</td> <td>2</td> <td>3</td> <td>5</td> <td>6</td> <td>6</td> <td>6</td> </tr> </table>						Working Voltage(VDC)	160	200	250	350	400	420	450	Z-25°C/Z+20°C	2	2	3	5	6	6	6	For Capacitance > 1000 µF, add 0.5 per another 1000 µF for -25°C/+20°C add 1 per another 1000 µF for -40°C/+20°C										
Working Voltage(VDC)	160	200	250	350	400	420	450																											
Z-25°C/Z+20°C	2	2	3	5	6	6	6																											
Endurance	Test conditions Duration time :2000Hrs Ambient temperature :+105°C Applied voltage :Rated DC working voltage After test requirement at +20°C Capacitance change :≤ ±20% of the initial measured value Dissipation factor :≤ 200% of the initial specified value Leakage current :≤ The initial specified value																																	
Shelf Life	Test conditions Duration time :1000Hrs Ambient temperature :+105°C Applied voltage :None After test requirement at +20°C:Same limits as Endurance. Pre-treatment for measurements shall be conducted after application of DC working voltage for 30 minutes.																																	

Multiplier for Ripple Current vs. Frequency

CAP(µF)\Frequency(Hz)	50(60)	120	400	1K	10K	50K-100K
CAP ≤ 10	0.8	1	1.30	1.45	1.65	1.70
10 < CAP ≤ 100	0.8	1	1.23	1.36	1.48	1.53
100 < CAP ≤ 1000	0.8	1	1.16	1.25	1.35	1.38
1000 < CAP	0.8	1	1.11	1.17	1.25	1.28

Diagram of Dimensions:(unit:mm)

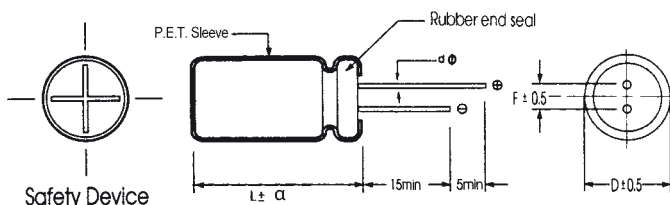

D φ	5	6.3	8	10	13	16	18	20	22
F	2.0	2.5	3.5	5.0	5.0	7.5	7.5	10	10
d φ	0.5		L < 20 0.5	L ≥ 20 0.6	0.6		0.8		

α	D < 18	D = 18		D > 18
		L < 35.5	L ≥ 35.5	
	1.5	1.5	2.0	2.0

Case Size

φ DxL(mm)

WV Cap(μF)	6.3		10		16		25		35	
	Size	Ripple	Size	Ripple	Size	Ripple	Size	Ripple	Size	Ripple
4.7							5X11	26	5X11	28
6.8							5X11	32	5X11	36
10					5X11	35	5X11	38	5X11	46
22			5X11	45	5X11	54	5X11	58	5X11	61
33	5X11	54	5X11	60	5X11	64	5X11	69	5X11	75
47	5X11	65	5X11	70	5X11	100	5X11	105	5X11	110
68	5X11	75	5X11	80	5X11	105	6.3X11	120	6.3X11	140
100	5X11	96	5X11	105	5X11	115	6.3X11	145	6.3X11	160
					6.3X11	130			8X11.5	175
120	5X11	110	5X11	110	6.3X11	155	6.3X11	175	8X11.5	185
			6.3X11	120						
150	5X11	120	5X11	120	6.3X11	170	6.3X11	180	8X11.5	215
	6.3X11	130	6.3X11	145			8X11.5	200		
180	6.3X11	140	6.3X11	160	6.3X11	190	8X11.5	210	8X11.5	225
									10X12.5	265
220	6.3X11	160	6.3X11	175	6.3X11	215	8X11.5	235	8X11.5	255
									10X12.5	300
330	6.3X11	195	6.3X11	205	6.3X11	225	8X11.5	310	10X12.5	400
			8X11.5	255	8X11.5	265	10X12.5	335		
470	6.3X11	220	6.3X11	235	8X11.5	370	8X11.5	410	10X16	520
	8X11.5	270	8X11.5	290	8X16	400	10X12.5	440		
560	8X11.5	310	8X11.5	330			10X16	460	10X20	540
			10X12.5	340	10X12.5	410				
680	8X11.5	360	8X11.5	365	8X16	470			10X20	560
			8X16	410	10X12.5	480	10X16	520	13X20	650
820	8X11.5	390	10X12.5	480	10X16	550	10X20	640	13X20	760
1000	10X12.5	430	10X12.5	520	10X12.5	540	10X20	710	13X20	830
					10X16	600				
1200	10X12.5	550	10X16	630	10X20	700	13X20	810	13X20	900
									13X25	930
1500	10X16	625	8X20	715	10X20	820	13X20	900	13X25	960
			10X16	770						
1800	10X16	710	10X20	820	13X20	920	13X25	1050	16X25	1150
2200	10X16	750	10X20	860	13X20	1000	13X25	1200	16X25	1290
	10X20	775							16X31.5	1350
2700	10X20	850	10X25	880	13X20	1080	16X25	1320	16X31.5	1480
			13X20	920						
3300	13X20	960	13X20	1100	13X25	1200	16X25	1460	16X35.5	1650
3900	13X20	1000	13X20	1280	16X25	1490	16X31.5	1670	18X31.5	1820
4700	13X20	1150	13X25	1350	16X25	1600	16X35.5	1780	18X35.5	1900
5600	13X25	1300	16X25	1490	16X31.5	1720	16X35.5	1890	18X35.5	2000
6800	13X25	1480	16X25	1670	16X31.5	1900	18X35.5	2050		
8200	16X25	1520	16X31.5	1840	16X35.5	2020	18X35.5	2090		
10000	16X25	1680	16X35.5	1900	18X35.5	2060				
12000	16X31.5	1750	16X35.5	2050	18X35.5	2150				
15000	16X35.5	2075	18X35.5	2180						
18000	18X31.5	2150	18X35.5	2205						
22000	18X41	2300								

Ripple Current (mA, rms) at 105°C 120Hz

φ DxL(mm)

WV Cap(μF)	50		63		100		160		200	
	Size	Ripple	Size	Ripple	Size	Ripple	Size	Ripple	Size	Ripple
0.1	5X11	1.3	5X11	1.3	5X11	1.9				
0.22	5X11	2.9	5X11	2.9	5X11	3.4				
0.33	5X11	4	5X11	4.5	5X11	5				
0.47	5X11	7	5X11	7	5X11	10	5X11	11	5X11	12
1	5X11	13	5X11	13	5X11	15	5X11	17	6.3X11	17
							6.3X11	19		
2.2	5X11	20	5X11	20	5X11	21	6.3X11	25	6.3X11	25
3.3	5X11	26	5X11	28	5X11	30	6.3X11	32	6.3X11	33
									8X11.5	35
4.7	5X11	32	5X11	32	5X11	35	6.3X11	38	6.3X11	42
							8X11.5	42	8X11.5	50
6.8	5X11	40	5X11	40	6.3X11	47	8X11.5	56	8X11.5	60
									10X12.5	63
10	5X11	48	5X11	42	6.3X11	56	8X11.5	63	8X11.5	78
			6.3X11	48	8X11.5	60	10X12.5	75	10X12.5	85
22	5X11	60	6.3X11	82	6.3X11	75	10X12.5	95	10X16	125
							10X16	105		
33	6.3X11	70			8X11.5	90	10X20	120	10X20	130
	5X11	75	6.3X11	100	8X11.5	140	10X16	155	10X16	160
47									10X20	180
	6.3X11	90			10X12.5	155	10X20	170	13X20	190
68	6.3X11	115	6.3X11	125	8X16	165	10X20	180	13X20	220
			8X11.5	140	10X12.5	170	13X20	210		
100	6.3X11	130	8X11.5	155	10X16	240	13X20	260	13X20	270
	8X11.5	155	10X12.5	185			13X25	280	13X25	300
120	8X11.5	200	10X12.5	230	10X20	280	13X25	310	13X25	320
							16X25	330	16X25	345
150	8X16	220	10X16	255	10X20	295	13X25	320	16X25	360
	10X12.5	225					16X25	350	16X31.5	390
180	10X12.5	245	10X16	270	13X20	340	16X25	470	16X25	440
					13X25	360			16X31.5	480
220	10X12.5	260	10X16	310	13X20	410	16X25	550	16X31.5	550
	10X16	280			13X25	480			16X35.5	560
330	10X12.5	345	10X16	375	13X25	520	16X31.5	560	16X35.5	670
	10X16	360	10X20	400			16X35.5	580	18X31.5	690
470	10X16	450	13X20	580	16X25	690	18X31.5	660	18X35.5	750
	10X20	470					18X35.5	700	18X41	810
560	10X20	600	13X20	690	16X25	820	18X35.5	810	18X41	840
	13X20	650			16X31.5	860	18X41	860	22X41	925
680	13X20	660	13X25	770	16X35.5	900			18X51	940
	13X20	700	16X25	880	16X35.5	920				
820	13X25	770			18X31.5	950				
	13X25	850	16X25	920	18X35.5	1020				
1000	13X25	890	16X31.5	1185	18X41	1200				
	16X25	1000								
1200	16X25	1150	16X35.5	1200						
1500	16X31.5	1300	18X31.5	1350						
1800	16X35.5	1480								
2200	16X35.5	1530								
2700	18X35.5	1590								
3300	18X35.5	1750								

Ripple Current (mA, rms) at 105°C 120Hz

φ DxDL(mm)

WV Cap(μF)	250		350		400		420		450	
	Size	Ripple	Size	Ripple	Size	Ripple	Size	Ripple	Size	Ripple
0.47	5X11	8	6.3X11	13	6.3X11	14	6.3X11	14	6.3X11	14
1	6.3X11	16	6.3X11	16	6.3X11	17	8X11.5	20	8X11.5	20
2.2	6.3X11	20	8X11.5	31	6.3X15	34	8X11.5	35	8X11.5	30
	8X11.5	25			8X11.5	35			10X12.5	35
3.3	8X11.5	33	8X11.5	34	6.3X15	35	10X12.5	42	8X11.5	32
			10X12.5	38	8X11.5	36			10X12.5	38
					8X16	40			10X16	42
					10X12.5	41				
4.7	8X11.5	46	8X11.5	47	8X11.5	48	10X12.5	58	8X16	44
					8X16	54			10X16	50
	10X12.5	50	10X12.5	52	10X12.5	55				
6.8					10X16	65	10X16	61	10X12.5	45
	8X11.5	60	10X12.5	79	8X14	75			10X16	50
	10X12.5	70			8X15	77	10X16	84	10X12.5	58
					8X16	80			10X16	65
					10X12.5	82			10X20	72
10					10X16	90				
	8X11.5	68	10X16	87	10X14	104			10X16	80
	10X12.5	80	10X20	92	10X15	107	10X20	112	10X20	92
					10X16	110			13X20	98
22					10X20	125				
	10X16	110	13X20	160	10X25	162				
	10X20	125			13X20	170				
	13X20	150	13X25	170	16X21	196			13X20	165
33					13X25	190			16X25	200
	13X20	190	13X20	180	13X20	235	13X25	185	13X25	180
			13X25	200	13X25	260	16X25	230	16X25	210
					16X21	270			16X31.5	230
					16X25	290				
47					16X25	300	16X25	280	16X25	305
					16X31.5	360	16X31.5	310	16X31.5	340
	13X20	230	16X25	245	18X25	320			16X31.5	380
	13X25	240	16X31.5	260					18X25	350
									18X31.5	360
56									16X31.5	370
	13X20	255	16X25	330	16X25	360	16X35.5	390	16X31.5	370
	13X25	280			16X31.5	400			16X35.5	400
68									18X25	370
	13X25	310			16X25	410	18X31.5	470	16X31.5	425
	16X25	355	16X31.5	370	16X31.5	450			16X35.5	450
					16X35.5	480			18X25	410
					18X25	440			18X31.5	460
82					18X31.5	500			18X35.5	470
	16X25	370	16X35.5	385	16X31.5	480	18X31.5	475	18X31.5	465
					18X25	470	18X35.5	500	18X35.5	480
					18X31.5	520				
100										
	16X25	375	18X31.5	390	16X35.5	520	16X35.5	525	18X31.5	500
	16X31.5	395			18X31.5	530	18X31.5	535	18X35.5	525
120					18X35.5	550	18X35.5	555	18X41	560
	16X31.5	420	16X41	400	18X31.5	550	18X31.5	560	18X41	580
	16X35.5	430	18X35.5	400	18X35.5	580	18X35.5	590	20X36	580
							18X41	630	22X41	650
150										
	16X35.5	460	18X41	420	18X35.5	610	18X35.5	615	18X45	690
	18X31.5	460			18X41	650	18X41	660	20X41	695
180					22X31	640			22X36	695
									22X41	720
	18X31.5	465	18X41	430	18X45	700	18X45	680		
	18X35.5	470					20X41	685		
220	18X35.5	650	22X41	500						
	18X41	700								
330	18X45	720								
	22X41	780								

Radial

KW Series 9-21mm Low Profile 105°C

Features

- ◆ Used space-saving equipment, low profile.
- ◆ Endurance 2000 hrs at 105°C.
- ◆ Safety vent construction design.
- ◆ RoHS Compliant

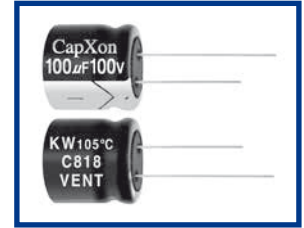

Specifications

Item	Performance Characteristics																																		
Operating Temperature Range	-40 to +105°C	-25 to +105°C																																	
Rated Voltage Range	6.3 to 100 VDC	160 to 450 VDC																																	
Capacitance Range	2.2 to 10000 µF	1.5 to 220 µF																																	
Capacitance Tolerance	±20% (120Hz, +20°C)																																		
Leakage Current (+20°C, max.)	I ≤ 0.01 CV or 3 (µA) After 2 minutes whichever is greater measures with rated working voltage applied.	I ≤ 0.04 CV + 100 (µA) After 2 minutes with rated working voltage applied.																																	
Dissipation Factor (tan δ, at 20°C, 120Hz)	<table border="1"> <tr> <th>Working Voltage(VDC)</th> <td>6.3</td> <td>10</td> <td>16</td> <td>25</td> <td>35</td> <td>50</td> <td>63</td> <td>100</td> </tr> <tr> <th>D.F. (%)max.</th> <td>24</td> <td>22</td> <td>20</td> <td>16</td> <td>14</td> <td>12</td> <td>10</td> <td>10</td> </tr> </table>								Working Voltage(VDC)	6.3	10	16	25	35	50	63	100	D.F. (%)max.	24	22	20	16	14	12	10	10									
	Working Voltage(VDC)	6.3	10	16	25	35	50	63	100																										
D.F. (%)max.	24	22	20	16	14	12	10	10																											
<table border="1"> <tr> <th>Working Voltage(VDC)</th> <td>160</td> <td>200</td> <td>250</td> <td>350</td> <td>400</td> <td>450</td> </tr> <tr> <th>D.F. (%)max.</th> <td>15</td> <td>15</td> <td>15</td> <td>15</td> <td>20</td> <td>20</td> </tr> </table> <p>For capacitance > 1000, add 2% per another 1000 µF.</p>									Working Voltage(VDC)	160	200	250	350	400	450	D.F. (%)max.	15	15	15	15	20	20													
Working Voltage(VDC)	160	200	250	350	400	450																													
D.F. (%)max.	15	15	15	15	20	20																													
Low Temperature Characteristics (at 120Hz)	Impedance ratio max																																		
	<table border="1"> <tr> <th>Working Voltage(VDC)</th> <td>6.3</td> <td>10</td> <td>16</td> <td>25</td> <td>35</td> <td>50</td> <td>63</td> <td>100</td> </tr> <tr> <th>Z-25°C / Z+20°C</th> <td>4</td> <td>3</td> <td>2</td> <td>2</td> <td>2</td> <td>2</td> <td>2</td> <td>2</td> </tr> <tr> <th>Z-40°C / Z+20°C</th> <td>8</td> <td>6</td> <td>4</td> <td>4</td> <td>3</td> <td>3</td> <td>3</td> <td>3</td> </tr> </table>								Working Voltage(VDC)	6.3	10	16	25	35	50	63	100	Z-25°C / Z+20°C	4	3	2	2	2	2	2	2	Z-40°C / Z+20°C	8	6	4	4	3	3	3	3
	Working Voltage(VDC)	6.3	10	16	25	35	50	63	100																										
Z-25°C / Z+20°C	4	3	2	2	2	2	2	2																											
Z-40°C / Z+20°C	8	6	4	4	3	3	3	3																											
<table border="1"> <tr> <th>Working Voltage(VDC)</th> <td>160</td> <td>200</td> <td>250</td> <td>350</td> <td>400</td> <td>450</td> </tr> <tr> <th>Z-25°C / Z+20°C</th> <td>3</td> <td>3</td> <td>3</td> <td>6</td> <td>6</td> <td>6</td> </tr> </table> <p>For Capacitance > 1000 µF, add 0.5 per another 1000 µF for -25°C / +20°C add 1 per another 1000 µF for -40°C / +20°C</p>								Working Voltage(VDC)	160	200	250	350	400	450	Z-25°C / Z+20°C	3	3	3	6	6	6														
Working Voltage(VDC)	160	200	250	350	400	450																													
Z-25°C / Z+20°C	3	3	3	6	6	6																													
Endurance	Test conditions Duration time :2000Hrs Ambient temperature :+105°C Applied voltage :Rated DC working voltage After test requirement at +20°C Capacitance change :≤ ±20% of the initial measured value Dissipation factor :≤ 200% of the initial specified value Leakage current :≤ The initial specified value																																		
Shelf Life	Test conditions Duration time :1000Hrs Ambient temperature :+105°C Applied voltage :None After test requirement at +20°C:Same limits as Endurance. Pre-treatment for measurements shall be conducted after application of DC working voltage for 30 minutes.																																		

Multiplier for Ripple Current vs. Frequency

CAP (µF) \ Frequency(Hz)	50(60)	120	400	1K	≥10K
0.47 < CAP ≤ 68	0.8	1	1.20	1.30	1.50
100 < CAP ≤ 1000	0.8	1	1.10	1.15	1.20
2200 < CAP ≤ 10000	0.8	1	1.05	1.10	1.15

Diagram of Dimensions:(unit:mm)

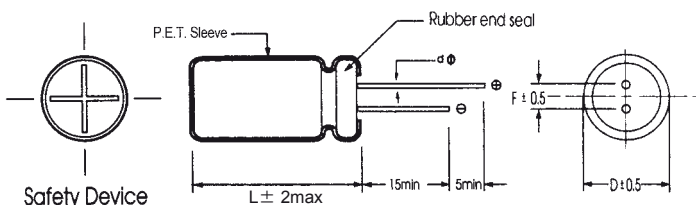

D φ	5	6.3	8	10	13	16	18
F	2.0	2.5	3.5	5.0	5.0	7.5	7.5
d φ	0.5		0.6		0.8		

Case Size

WV Cap(μF)		6.3		10		16		25		35		50		63		φ DxL(mm)
		Size	Ripple	Size	Ripple	Size	Ripple	Size	Ripple	Size	Ripple	Size	Ripple	Size	Ripple	
2.2												5x9	19	5x9	20	
3.3												5x9	25	5x9	26	
4.7												5x9	40	5x9	41	
6.8												5x9	48	5x9	49	
10												5x9	54	5x9	55	
22												5x9	75	6.3x9	107	
33												5x9	90	6.3x9	115	6.3x9
47						5x9	105	5x9	110	6.3x9	120	6.3x9	130	8x9	136	
68			5x9	115	6.3x9	125	6.3x9	130	8x9	145	8x9	169	10x9	10x9	170	
100	5x9	120	5x9	135	6.3x9	150	6.3x9	160	8x9	180	10x9	200	10x9	10x9	173	
150	5x9	135	6.3x9	150	6.3x9	160	8x9	185	8x9	210	10x9	250	10x16	245		
220	6.3x9	165	6.3x9	165	8x9	200	8x9	230	10x9	255	10x12.5	290	13x13	317		
330	6.3x9	185	8x9	205	8x9	250	10x9	310	10x12.5	360	13x13	375	13x16	382		
											13x16	400				
470	8x9	260	8x9	275	10x9	310	10x12.5	370	13x13	410	16x16	550	16x16	490		
			10x9	280					13x16	430						
680	10x9	310	10x9	360	13x13	390	13x16	520	13x16	580	16x16	700	16x21	730		
1000	10x9	370	10x9	450	13x13	520	13x16	600	16x16	750	16x21	850	16x25	1050		
2200	13x16	620	13x16	690	16x16	850	16x21	950	18x21	1200	18x25	1300				
							18x15	940								
3300	16x16	860	16x16	950	16x21	1180	18x21	1250	18x25	1450						
4700	16x16	1010	16x21	1150	18x21	1480	18x25	1470								
6800	16x16	1210	18x21	1350	18x25	1600										
10000	18x21	1450	18x25	1700												

WV Cap(μF)		100		160		200		250		350		400		450	
		Size	Ripple	Size	Ripple	Size	Ripple	Size	Ripple	Size	Ripple	Size	Ripple	Size	Ripple
1.5														8x9	18
2.2	5x9	20										8x9	35	10x9	25
3.3	5x9	27								8x9	35	10x9	40	10x9	30
4.7	5x9	42	8x9	50	8x9	50	8x9	50	10x9	50	13x16	50	13x16	48	
6.8	6.3x9	56	8x9	55	8x9	58	10x9	65	13x16	80	13x16	80	13x16	68	
10	8x9	72	10x9	80	10x9	78	13x16	82	13x16	95	13x16	100	16x16	100	
										16x16	105				
22	8x9	114	13x16	120	13x16	145	13x16	165	16x16	180	16x21	185	16x21	170	
							16x16	180							
33	10x9	141	13x16	175	16x16	200	16x16	225	16x21	225	16x21	230			
47	10x16	197	16x16	225	16x16	240	18x16	350	18x21	300	18x21	309			
68	10x16	200	16x21	305	16x21	360	18x21	390							
100	13x13	247	16x21	380	18x21	410									
	13x16	295	18x21	530											
150	16x16	346													
220	16x16	373													
330	16x21	500													
470															

Ripple Current (mA, rms) at 105°C 120Hz

Radial

KC 105°C 3000 hours, Ultra Miniaturize

Features

- ◆ Endurance 3000 hours 105°C
- ◆ ROHS compliant

KM Ultra miniaturized **KC**

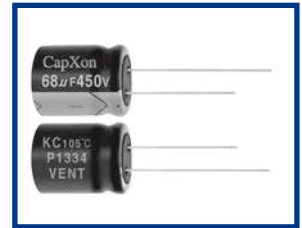

Specifications

Item	Performance Characteristics			
Operating Temperature Range	-25 to +105°C			
Rated Voltage Range	400 to 450 VDC			
Capacitance Tolerance	±20% (120Hz, +20°C)			
Leakage Current (+20°C, max.)	$I \leq 3\sqrt{CV}$ (µA) After 5 minute with rated working voltage applied. C: rated Capacitance (µF) · V: working voltage(V)			
Dissipation Factor (tan δ · at 20°C · 120Hz)	Less than the value under table			
	<table border="1"> <tr> <td>Cap(µF) / W.V.(V)</td> <td>400~450V</td> </tr> <tr> <td>tan δ</td> <td>20%</td> </tr> </table>	Cap(µF) / W.V.(V)	400~450V	tan δ
Cap(µF) / W.V.(V)	400~450V			
tan δ	20%			
Low Temperature Characteristics (at 120Hz)	Impedance ratio max			
	<table border="1"> <tr> <td>Rated voltage(V)</td> <td>400~450</td> </tr> <tr> <td>Z-25°C / Z+20°C</td> <td>8</td> </tr> </table>	Rated voltage(V)	400~450	Z-25°C / Z+20°C
Rated voltage(V)	400~450			
Z-25°C / Z+20°C	8			
Endurance	Test conditions Duration time :3000Hrs Ambient temperature :+105°C Applied voltage :Rated DC working voltage After test requirement at +20°C Capacitance change :Within ±20% of the initial measured value Dissipation factor :Not more than 200% of the initial specified value Leakage current :Not more than The initial specified value			
Shelf Life	Test conditions Duration time :1000Hrs Ambient temperature :+105°C Applied voltage :None After test requirement at +20°C: Same limits as Endurance. Pre-treatment for measurements shall be conducted after application of DC working voltage for 30 minutes.			

Multiplier for Ripple Current vs. Frequency

Frequency(Hz)	50(60)	120	400	1K	10K	50K-100K	
Coefficient	400~450V	0.8	1	1.30	1.45	1.65	1.5

Diagram of Dimensions:(unit:mm)

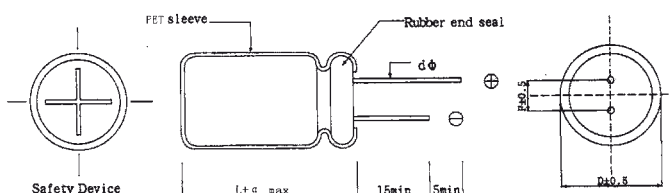

φD	10~13	16~18
F	5.0	7.5
φd	0.6	0.8
α	2.0	

Case Size

WV Cap(μ F)	400		420		450	
	Size	Ripple	Size	Ripple	Size	Ripple
82	16x25	600			16x31.5	640
100	16x31.5	710	16x31.5	690	16x35.5	730
120	16x35.5	800	16x35.5	780	16x41	820
			18x31.5	800	18x31.5	800
150	16x41	920	16x45	940	16x51	980
	18x31.5	890	18x35.5	920	18x41	970
180	16x51	1080	16x51	1050	18x45	1090
	18x41	1060	18x41	1040	18x45	1090
220	18x45	1200	18x51	1220	18x51	1220

ϕ DxL(mm)

Ripple Current (mA, rms) at 105°C 120Hz

LL Series Low Leakage Current

Features

- ◆ Extremely low and stable leakage current characteristics.
- ◆ Close capacitance tolerance $\pm 20\%$ ($\pm 10\%$ on requested)
- ◆ RoHS Compliant

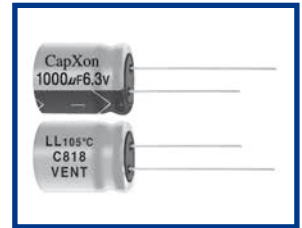

Specifications

Item	Performance Characteristics																
Operating Temperature Range	-40 to +105°C																
Rated Voltage Range	6.3 to 63 VDC																
Capacitance Range	0.1 to 2200 μ F																
Capacitance Tolerance	$\pm 20\%$ (120Hz, +20°C)																
Leakage Current(+20°C, max)	$I \leq 0.002 CV$ or $0.4 (\mu A)$ After 3 minutes(90sec. $\leq 10 \mu F$) whichever is greater measured with rated working voltage applied.																
Dissipation Factor ($\tan \delta$, at 20°C , 120Hz)	<table border="1"> <tr> <td>Working Voltage (VDC)</td> <td>6.3</td> <td>10</td> <td>16</td> <td>25</td> <td>35</td> <td>50</td> <td>63</td> </tr> <tr> <td>D.F. (%)max</td> <td>20</td> <td>17</td> <td>13</td> <td>10</td> <td>9</td> <td>8</td> <td>8</td> </tr> </table>	Working Voltage (VDC)	6.3	10	16	25	35	50	63	D.F. (%)max	20	17	13	10	9	8	8
	Working Voltage (VDC)	6.3	10	16	25	35	50	63									
D.F. (%)max	20	17	13	10	9	8	8										
Low Temperature Characteristics (at 120Hz)	Impedance ratio max <table border="1"> <tr> <td>Working Voltage (VDC)</td> <td>6.3</td> <td>10</td> <td>16</td> <td>25</td> <td>35</td> <td>50</td> <td>63</td> </tr> <tr> <td>Z-40°C / Z+20°C</td> <td>4</td> <td>3</td> <td>3</td> <td>2</td> <td>2</td> <td>2</td> <td>2</td> </tr> </table>	Working Voltage (VDC)	6.3	10	16	25	35	50	63	Z-40°C / Z+20°C	4	3	3	2	2	2	2
	Working Voltage (VDC)	6.3	10	16	25	35	50	63									
Z-40°C / Z+20°C	4	3	3	2	2	2	2										
Endurance	Test conditions Duration time :2000Hrs Ambient temperature :+105°C Applied voltage :Rated DC working voltage After test requirement at +20°C Capacitance change $\leq \pm 20\%$ of the initial measured value Dissipation factor $\leq 150\%$ of the initial specified value Leakage current \leq The initial specified value																
Shelf Life	Test conditions Duration time :1000Hrs Ambient temperature :+105°C Applied voltage :None After test requirement at +20°C:Same limits as Endurance. Pre-treatment for measurements shall be conducted after application of DC working voltage for 30 minutes.																

Multiplier for Ripple Current vs. Frequency

CAP(μ F) \ Frequency(Hz)	50(60)	120	400	1K	10K	50K-100K
$CAP \leq 10$	0.8	1	1.30	1.45	1.65	1.70
$10 < CAP \leq 100$	0.8	1	1.23	1.36	1.48	1.53
$100 < CAP \leq 2200$	0.8	1	1.16	1.25	1.35	1.38

Diagram of Dimensions:(unit:mm)

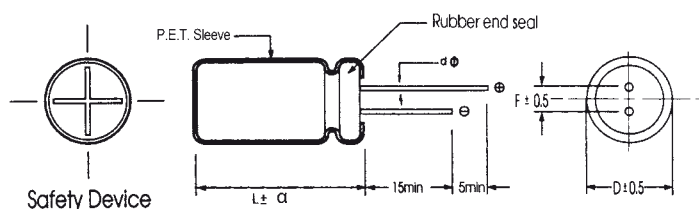

α	D < 18	D = 18		D > 18
		L < 35.5	L \geq 35.5	
	1.5	1.5	2	2

D ϕ	5	6.3	8	10	13
F	2.0	2.5	3.5	5.0	5.0
d ϕ	0.5			0.6	

Case Size

WV Cap(μF)		6.3		10		16		25		35		50		63	
		Size	Ripple	Size	Ripple	Size	Ripple	Size	Ripple	Size	Ripple	Size	Ripple	Size	Ripple
0.1												5x11	8.8	5x11	8.8
0.22												5x11	8.8	5x11	8.8
0.33												5x11	8.8	5x11	8.8
0.47												5x11	12	5x11	12
1												5x11	17	5x11	17
2.2												5x11	24	5x11	24
3.3												5x11	29	5x11	32
4.7								5x11	32	5x11	33	5x11	36	5x11	39
10						5x11	39	5x11	43	5x11	48	5x11	52	6.3x11	58
22	5x11	36	5x11	50	5x11	62	5x11	65	6.3x11	71	6.3x11	77	6.3x11	94	
33	5x11	44	5x11	66	5x11	68	5x11	76	6.3x11	83	6.3x11	99	8x11.5	110	
47	5x11	53	5x11	75	5x11	105	6.3x11	116	6.3x11	125	8x11.5	138	8x11.5	152	
100	5x11	74	5x11	104	6.3x11	138	8x11.5	149	8x11.5	187	10x12.5	217	10x16	260	
220	6.3x11	131	8x11.5	193	8x11.5	220	10x12.5	246	10x12.5	330	10x20	380	13x20	440	
330	6.3x11	161	8x11.5	256	8x11.5	268	10x12.5	352	10x16	440	13x20	506	13x25	594	
470	8x11.5	242	8x11.5	319	10x12.5	407	10x16	484	13x20	590	13x25	705			
1000	10x12.5	390	10x16	605	10x20	704	13x20	847	13x25	1012					
2200	13x20	665	13x20	860	13x25	890									

φ DxL(mm)

Ripple Current (mA, rms) at 105°C 120Hz

GL Series Low Impedance, Long Life

Features

- ◆ Low impedance for high frequency, Anti-Solvent Design.
- ◆ Long Life 2000 ~ 6000 hrs at 105°C depending on case size.
- ◆ Radial type for switching power supply.
- ◆ RoHS Compliant

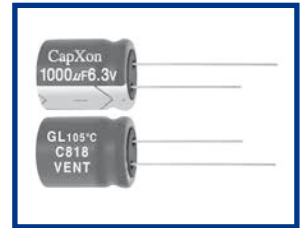

Specifications

Item	Performance Characteristics																																	
Operating Temperature Range	-55 to +105°C																																	
Rated Voltage Range	6.3 to 63 VDC																																	
Capacitance Range	0.47 to 10000 µF																																	
Capacitance Tolerance	±20% (120Hz, +20°C)																																	
Leakage Current (+20°C, max.)	I ≤ 0.01 CV or 3 (µA) After 2 minutes whichever is greater measured with rated working voltage applied.																																	
Dissipation Factor (tan δ, at 20°C, 120Hz)	<table border="1"> <tr> <th>Working Voltage (VDC)</th> <td>6.3</td> <td>10</td> <td>16</td> <td>25</td> <td>35</td> <td>50</td> <td>63</td> </tr> <tr> <th>D.F. (%)max</th> <td>20</td> <td>18</td> <td>16</td> <td>14</td> <td>12</td> <td>10</td> <td>9</td> </tr> </table>		Working Voltage (VDC)	6.3	10	16	25	35	50	63	D.F. (%)max	20	18	16	14	12	10	9																
	Working Voltage (VDC)	6.3	10	16	25	35	50	63																										
D.F. (%)max	20	18	16	14	12	10	9																											
For Capacitance > 1000 µF, add 2% per another 1000 µF.																																		
Low Temperature Characteristics (at 120Hz)	Impedance ratio max																																	
	<table border="1"> <tr> <th>Working Voltage(VDC)</th> <td>6.3</td> <td>10</td> <td>16</td> <td>25</td> <td>35</td> <td>50</td> <td>63</td> </tr> <tr> <th>Z-25°C/Z+20°C</th> <td>4</td> <td>3</td> <td>2</td> <td>2</td> <td>1.5</td> <td>1.5</td> <td>1.5</td> </tr> <tr> <th>Z-40°C/Z+20°C</th> <td>6</td> <td>4</td> <td>3</td> <td>3</td> <td>2</td> <td>2</td> <td>2</td> </tr> <tr> <th>Z-55°C/Z+20°C</th> <td>8</td> <td>6</td> <td>5</td> <td>5</td> <td>4</td> <td>4</td> <td>4</td> </tr> </table>		Working Voltage(VDC)	6.3	10	16	25	35	50	63	Z-25°C/Z+20°C	4	3	2	2	1.5	1.5	1.5	Z-40°C/Z+20°C	6	4	3	3	2	2	2	Z-55°C/Z+20°C	8	6	5	5	4	4	4
	Working Voltage(VDC)	6.3	10	16	25	35	50	63																										
	Z-25°C/Z+20°C	4	3	2	2	1.5	1.5	1.5																										
Z-40°C/Z+20°C	6	4	3	3	2	2	2																											
Z-55°C/Z+20°C	8	6	5	5	4	4	4																											
For Capacitance > 1000 µF, add 0.5 per another 1000 µF for -25°C/+20°C add 1 per another 1000 µF for -40°C/+20°C add 1.5 per another 1000 µF for -55°C/+20°C																																		
Endurance	Test conditions																																	
	Duration time :as right Ambient temperature :+105°C Applied voltage :Rated DC working voltage After test requirement at +20°C Capacitance change :≤ ±20% of the initial measured value Dissipation factor :≤ 200% of the initial specified value Leakage current :≤ The initial specified value	<table border="1"> <tr> <th>D φ</th> <th>Life hours</th> </tr> <tr> <td>5 - 6.3 φ</td> <td>2000</td> </tr> <tr> <td>8 φ</td> <td>3000</td> </tr> <tr> <td>≥ 10 φ</td> <td>6000</td> </tr> </table>	D φ	Life hours	5 - 6.3 φ	2000	8 φ	3000	≥ 10 φ	6000																								
D φ	Life hours																																	
5 - 6.3 φ	2000																																	
8 φ	3000																																	
≥ 10 φ	6000																																	
Shelf Life	Test conditions Duration time :1000Hrs Ambient temperature :+105°C Applied voltage :None After test requirement at +20°C:Same limits as Endurance. Pre-treatment for measurements shall be conducted after application of DC working voltage for 30 minutes.																																	

Multiplier for Ripple Current vs. Frequency

CAP(µF)\Frequency(Hz)	50(60)	120	400	1K	10K	50K-100K
CAP ≤ 10	0.47	0.59	0.76	0.85	0.97	1
10 < CAP ≤ 100	0.52	0.65	0.80	0.89	0.97	1
100 < CAP ≤ 1000	0.58	0.72	0.84	0.90	0.98	1
1000 < CAP	0.63	0.78	0.87	0.91	0.98	1

Diagram of Dimensions:(unit:mm)

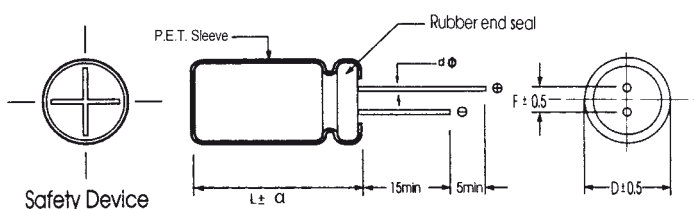

D φ	5	6.3	8	10	13	16	18	22
F	2.0	2.5	3.5	5.0	5.0	7.5	7.5	10
d φ	0.5		L < 20 0.5	L ≥ 20 0.6	0.6		0.8	

α	D < 18	D = 18		D > 18
		L < 35.5	L ≥ 35.5	
	1.5	1.5	2.0	2.0

Case Size

WV	6.3			10			16		
	Size	Ripple	Impedance	Size	Ripple	Impedance	Size	Ripple	Impedance
10							5x11	37	4.00
15							5x11	60	3.52
22				5x11	56	2.60	5x11	70	2.00
27				5x11	57	2.40	5x11	110	1.60
33				5x11	58	2.20	5x11	130	1.26
39				5x11	95	1.85	5x11	150	0.87
47				5x11	120	1.20	5x11	190	0.52
56				5x11	130	1.05	5x11	205	0.49
68				5x11	145	0.89	5x11	210	0.45
82				5x11	170	0.75	6.3x11	250	0.37
100	5x11	185	0.95	5x11	205	0.48	6.3x11	260	0.31
120	5x11	190	0.90	5x11	230	0.44	6.3x11	290	0.29
150	6.3x11	210	0.75	6.3x11	270	0.37	6.3x11	300	0.26
180	6.3x11	240	0.70	6.3x11	290	0.35	6.3x15	370	0.23
							8x11.5	368	0.24
220	6.3x11	300	0.55	6.3x11	330	0.28	6.3x15	470	0.20
							8x11.5	455	0.21
270	6.3x11	310	0.49	6.3x15	370	0.25	8x11.5	490	0.17
				8x11.5	390	0.21			
330	6.3x15	320	0.34	6.3x15	445	0.15	8x11.5	550	0.12
	8x11.5	390	0.30	8x11.5	430	0.16			
470	6.3x15	435	0.25	8x11.5	555	0.115	8x16	745	0.092
	8x11.5	430	0.22				10x12.5	722	0.095
560	8x11.5	480	0.20	8x11.5	620	0.095	10x12.5	780	0.082
680	8x11.5	510	0.18	8x16	630	0.090	10x16	920	0.074
820	8x16	620	0.14	8x20	870	0.084	10x16	1020	0.067
1000	8x16	710	0.10	8x20	1040	0.070	10x20	1180	0.050
	10x12.5	625	0.12	10x16	1010	0.072			
1200	10x16	810	0.095	10x16	1130	0.062	10x25	1370	0.047
1500	10x16	1050	0.074	10x20	1270	0.056	10x25	1470	0.041
1800	10x20	1200	0.065	10x25	1430	0.045	13x20	1630	0.038
				13x20	1450	0.048			
2200	10x20	1300	0.060	13x20	1690	0.040	13x20	1800	0.035
	10x25	1400	0.057				13x25	1950	0.033
2700	10x25	1400	0.055	13x20	1800	0.033	13x25	2050	0.031
	13x20	1410	0.052						
3300	13x20	1500	0.048	13x25	1980	0.029	13x30	2410	0.025
							16x25	2340	0.028
4700	13x25	1800	0.032	13x30	2300	0.025	16x31.5	2650	0.022
	13x30	1950	0.025	16x25	2100	0.029	18x25	2570	0.024
6800	13x30	2020	0.024	16x31.5	2340	0.023	18x31.5	2700	0.020
	16x25	2230	0.021						
8200	16x31.5	2530	0.020	16x35.5	2580	0.019	18x35.5	2830	0.018
10000	16x35.5	2740	0.019	18x31.5	2770	0.017	18x41	3300	0.015

Ripple Current (mA, rms) at 105°C 100KHz
 Max Impedance (Ω) at 20°C 100KHz

Radial

φ DxL(mm)

WV Cap(μF)	25			35			50			63		
	Size	Ripple	Impedance	Size	Ripple	Impedance	Size	Ripple	Impedance	Size	Ripple	Impedance
0.47							5x11	15	5.00	5x11	16	5.00
1							5x11	25	3.95	5x11	27	3.95
2.2							5x11	33	2.60	5x11	38	2.60
3.3							5x11	45	2.00	5x11	48	2.00
4.7							5x11	58	1.89	5x11	62	1.89
5.6							5x11	80	1.85	5x11	85	1.82
6.8							5x11	85	1.77	5x11	90	1.75
8.2							5x11	90	1.72	5x11	100	1.69
10	5x11	56	2.10	5x11	70	1.90	5x11	100	1.70	5x11	105	1.65
15	5x11	97	1.95	5x11	115	1.72	5x11	110	1.53	5x11	110	1.47
22	5x11	120	1.80	5x11	130	1.36	6.3x11	135	1.00	6.3x11	170	0.80
27	5x11	130	1.56	5x11	140	1.20	6.3x11	160	0.93	6.3x11	190	0.75
33	5x11	150	1.20	5x11	175	0.95	6.3x11	230	0.74	8x11.5	245	0.61
39	5x11	170	0.82	6.3x11	200	0.74	6.3x11	240	0.65	8x11.5	270	0.58
47	5x11	220	0.50	6.3x11	250	0.44	8x11.5	285	0.50	8x11.5	290	0.56
56	5x11	245	0.44	6.3x11	270	0.40	8x11.5	300	0.39	8x11.5	320	0.38
68	6.3x11	270	0.39	6.3x11	300	0.35	8x11.5	340	0.30	8x16	480	0.30
82	6.3x11	285	0.33	6.3x15	350	0.29	8x11.5	400	0.25	8x16	510	0.28
100	6.3x11	300	0.28	6.3x15	390	0.18	8x16	475	0.18	10x16	590	0.24
				8x11.5	380	0.19						
120	6.3x11	350	0.22	8x11.5	460	0.17	8x16	520	0.17	10x16	660	0.16
150	6.3x15	420	0.20	8x16	580	0.15	10x16	675	0.13	10x20	790	0.11
180	6.3x15	440	0.18	8x16	630	0.13	10x16	760	0.095	10x20	850	0.095
	8x11.5	435	0.19									
220	8x11.5	550	0.125	8x16	740	0.095	10x20	900	0.085	10x25	1020	0.082
				10x12.5	720	0.098						
270	8x11.5	620	0.095	8x20	830	0.086	10x20	950	0.075	13x20	1054	0.080
				10x16	840	0.088						
330	8x16	740	0.085	10x16	995	0.065	10x25	1050	0.068	10x30	1200	0.064
	10x12.5	720	0.082							13x25	1160	0.067
470	10x16	1040	0.065	10x20	1150	0.050	13x20	1490	0.048	16x25	1750	0.048
560	10x16	1070	0.061	10x25	1310	0.048	13x20	1550	0.045	16x25	1830	0.044
680	10x20	1280	0.052	13x20	1440	0.044	13x25	1840	0.041	16x31.5	2070	0.040
820	10x25	1460	0.043	13x20	1600	0.038	13x30	2060	0.036	16x31.5	2100	0.035
1000	10x25	1530	0.039	13x30	1950	0.036	13x40	2200	0.033	16x35.5	2450	0.031
	13x25	1580	0.038				16x31.5	2130	0.030			
1200	13x25	1800	0.036	16x25	2200	0.029	16x31.5	2520	0.027	18x31.5	2500	0.026
1500	13x25	2020	0.032	16x31.5	2520	0.027	16x35.5	2700	0.026	18x35.5	2700	0.025
1800	13x30	2300	0.027	16x31.5	2560	0.026	18x31.5	2800	0.025	18x41	2900	0.024
2200	13x30	2480	0.025	16x31.5	2650	0.025	18x35.5	2900	0.024	18x41	2990	0.023
	16x25	2405	0.027	18x25	2570	0.026						
2700	16x31.5	2670	0.024	18x31.5	2660	0.023	18x41	2970	0.021			
3300	16x31.5	2960	0.020	18x35.5	3000	0.020						
	18x25	3050	0.022									
4700	16x41	3490	0.022	18x41	3300	0.019						
	18x35.5	3520	0.021									
6800	18x41	3600	0.017									

Ripple Current (mA, rms) at 105°C 100KHz
 Max Impedance (Ω) at 20°C 100KHz

KF Series Low Impedance

Features

- ◆ Used in communication equipments, switching power supply, industrial measuring instruments, etc.
- ◆ Endurance 2000~5000 Hrs at 105°C
- ◆ Safety vent construction design.
- ◆ RoHS Compliant

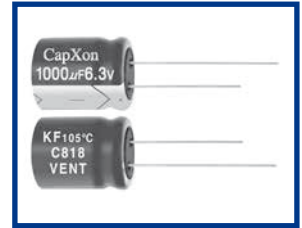

Specifications

Item	Performance Characteristics																																		
Operating Temperature Range	-40 to +105°C	-25 to +105°C																																	
Rated Voltage Range	6.3 to 100 VDC	160 to 450 VDC																																	
Capacitance Range	0.47 to 15000 µF	0.47 to 470 µF																																	
Capacitance Tolerance	±20%(120Hz,+20°C)																																		
Leakage Current (+20°C,max.)	I ≤ 0.01 CV or 3 (µA) After 2 minutes whichever is greater measured with rated working voltage applied.	I ≤ 0.03 CV (µA) After 2 minutes withrate working voltage applied.																																	
	<table border="1"> <tr> <td>Working Voltage(VDC)</td> <td>6.3</td> <td>10</td> <td>16</td> <td>25</td> <td>35</td> <td>50</td> <td>63</td> <td>100</td> </tr> <tr> <td>D.F. (%)max.</td> <td>18</td> <td>16</td> <td>14</td> <td>12</td> <td>10</td> <td>9</td> <td>8</td> <td>8</td> </tr> </table> <table border="1"> <tr> <td>Working Voltage(VDC)</td> <td>160</td> <td>200</td> <td>250</td> <td>350</td> <td>400</td> <td>420</td> <td>450</td> </tr> <tr> <td>D.F. (%)max.</td> <td>12</td> <td>12</td> <td>12</td> <td>15</td> <td>15</td> <td>17</td> <td>17</td> </tr> </table> <p>For capacitance > 1000 µF, add 2% per another 1000uF.</p>		Working Voltage(VDC)	6.3	10	16	25	35	50	63	100	D.F. (%)max.	18	16	14	12	10	9	8	8	Working Voltage(VDC)	160	200	250	350	400	420	450	D.F. (%)max.	12	12	12	15	15	17
Working Voltage(VDC)	6.3	10	16	25	35	50	63	100																											
D.F. (%)max.	18	16	14	12	10	9	8	8																											
Working Voltage(VDC)	160	200	250	350	400	420	450																												
D.F. (%)max.	12	12	12	15	15	17	17																												
Dissipation Factor (tan δ , at 20°C , 120Hz)	Impedance ratio max																																		
	Working Voltage(VDC)	6.3	10	16	25	35	50	63	100																										
	Z-25°C / Z+20°C	4	3	3	3	3	3	2	2																										
	Z-40°C / Z+20°C	8	6	4	3	3	3	3	3																										
Low Temperature Characteristics (at 120Hz)	Working Voltage(VDC)	160	200	250	350	400	450																												
	Z-25°C / Z+20°C	2	2	3	5	5	6																												
	Z-40°C / Z+20°C	3	6	6	6	6	-																												
	For capacitance > 1000 µF, add 0.5 per another 1000uF for -25°C / +20°C add 1 per another 1000uF for -40°C / +20°C																																		
Endurance	Test conditions Duration time : as right Ambient temperature : +105°C Applied voltage : Rated DC working voltage After test requirement at +20°C Capacitance change : ≤ ±20% of the initial measured value Dissipation factor : ≤ 200% of the initial specified value Leakage current : ≤ The initial specified value							<table border="1"> <tr> <th>D φ</th> <th>Life hours</th> </tr> <tr> <td>5 - 6.3 φ</td> <td>2000</td> </tr> <tr> <td>8 φ</td> <td>3000</td> </tr> <tr> <td>≥ 10 φ</td> <td>5000</td> </tr> </table>		D φ	Life hours	5 - 6.3 φ	2000	8 φ	3000	≥ 10 φ	5000																		
	D φ	Life hours																																	
5 - 6.3 φ	2000																																		
8 φ	3000																																		
≥ 10 φ	5000																																		
		(160-450V : 2000hrs)																																	
Shelf Life	Test conditions Duration time : 1000Hrs Ambient temperature : +105°C Applied voltage : None After test requirement at +20°C: Same limits as Endurance. Pre-treatment for measurements shall be conducted after application of DC working voltage for 30 minutes.																																		

Multiplier for Ripple Current vs. Frequency

CAP(µF)\Frequency(Hz)	50(60)	120	400	1K	10K	50K-100K
CAP ≤ 10	0.47	0.59	0.76	0.85	0.97	1
10 < CAP ≤ 100	0.52	0.62	0.80	0.89	0.97	1
100 < CAP ≤ 1000	0.58	0.72	0.84	0.90	0.98	1
1000 < CAP	0.63	0.78	0.87	0.91	0.98	1

Diagram of Dimensions:(unit:mm)

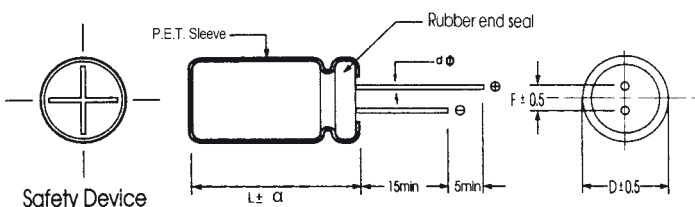

D φ	5	6.3	8	10	13	16	18	22
F	2.0	2.5	3.5	5.0	5.0	7.5	7.5	10
d φ	0.5		L < 20 0.5	L ≥ 20 0.6	0.6		0.8	
	α		D = 18		D > 18			
		D < 18	L < 35.5	L ≥ 35.5				
		1.5	1.5	2.0	2.0			

Case Size

WV	6.3			10			16		
	Size	Ripple	Impedance	Size	Ripple	Impedance	Size	Ripple	Impedance
10							5x11	74	4.7
22				5x11	98	2.7	5x11	100	2.6
33				5x11	100	2.6	5x11	114	2
47				5x11	150	1.34	5x11	155	1.1
56				5x11	160	1.23	5x11	180	0.82
68				5x11	170	1.05	5x11	195	0.69
100	5x11	170	1.00	5x11	210	0.8	6.3x11	265	0.5
120	5x11	175	0.92	6.3x11	250	0.75	6.3x11	270	0.47
150	6.3x11	220	0.81	6.3x11	290	0.61	6.3x11	290	0.41
	5x11	185	0.90						
180	6.3x11	240	0.76	6.3x11	320	0.46	8x11.5	370	0.34
							6.3x11	315	0.38
220	6.3x11	310	0.65	6.3x11	340	0.35	8x11.5	480	0.25
270	6.3x11	340	0.54	8x11.5	400	0.3	8x11.5	520	0.21
330	8x11.5	390	0.42	8x11.5	460	0.27	8x11.5	590	0.156
470	8x11.5	450	0.25	8x11.5	580	0.25	10x12.5	750	0.124
560	8x11.5	490	0.23	10x12.5	635	0.16	10x12.5	785	0.105
				8x11.5	550	0.17			
680	8x11.5	550	0.21	10x12.5	765	0.11	10x16	1100	0.092
820	8x16	620	0.20	10x16	890	0.1	10x16	1180	0.078
1000	10x12.5	770	0.17	10x16	1040	0.076	10x20	1350	0.065
	8x16	750	0.18						
1200	10x16	860	0.16	10x16	1200	0.067	10x25	1500	0.061
1500	10x16	1100	0.14	10x20	1400	0.062	10x30	1600	0.056
							13x20	1380	0.06
1800	10x20	1250	0.11	10x25	1550	0.058	13x20	1800	0.047
							10x25	1730	0.05
2200	10x20	1380	0.090	13x20	1750	0.041	13x25	2000	0.038
	10x25	1470	0.095	10x25	1650	0.052	13x20	1880	0.04
2700	10x25	1490	0.075	13x20	1900	0.035	13x25	2450	0.033
	13x20	1550	0.075						
3300	13x20	1650	0.036	13x25	2000	0.031	16x25	2790	0.030
							13x30	2640	0.030
4700	13x30	2100	0.036	16x25	2100	0.030	16x31.5	2880	0.026
	13x25	1900	0.040						
5600	13x30	2160	0.034	16x25	2290	0.028	16x35.5	2990	0.025
6800	16x25	2350	0.032	16x31.5	2650	0.026	18x35.5	3200	0.024
8200	16x31.5	2550	0.027	16x35.5	2770	0.026	18x35.5	3320	0.024
10000	16x35.5	2700	0.024	18x35.5	2850	0.024	18x41	3550	0.024
15000	18x35.5	2950	0.023						

Ripple Current (mA, rms) at 105°C 100KHz
 Max Impedance (Ω) at 20°C 100KHz

WV Cap(μ F)	25			35			50		
	Size	Ripple	Impedance	Size	Ripple	Impedance	Size	Ripple	Impedance
0.47							5x11	25	5.4
1							5x11	40	4
2.2							5x11	55	2.8
3.3							5x11	60	2.2
4.7	5x11	68	3.95	5x11	85	3.65	5x11	90	2
5.6	5x11	75	3.25	5x11	92	3.09	5x11	105	1.93
6.8	5x11	80	2.98	5x11	97	2.82	5x11	110	1.89
10	5x11	85	2.56	5x11	105	2.37	5x11	120	1.82
22	5x11	125	1.95	5x11	150	1.5	6.3x11	150	1.25
33	5x11	155	1.42	5x11	180	1.21	6.3x11	250	0.8
47	5x11	190	1.10	6.3x11	280	0.8	6.3x11	290	0.65
	6.3x11	220	1.00						
56	6.3x11	250	0.79	6.3x11	310	0.64	8x11.5	310	0.49
68	6.3x11	280	0.65	8x11.5	350	0.52	8x11.5	375	0.33
100	6.3x11	370	0.35	8x11.5	450	0.25	10x12.5	480	0.17
120	6.3x11	380	0.33	8x11.5	510	0.22	10x12.5	530	0.156
150	8x11.5	410	0.31	8x11.5	540	0.191	10x12.5	590	0.132
180	8x11.5	455	0.25	10x12.5	650	0.172	10x16	860	0.114
220	8x11.5	550	0.15	10x12.5	750	0.114	10x16	930	0.096
270	10x12.5	720	0.125	10x16	910	0.095	10x20	1060	0.078
330	10x12.5	820	0.114	10x16	1050	0.079	10x25	1150	0.065
470	10x16	1200	0.076	10x20	1200	0.065	13x20	1590	0.055
560	10x16	1250	0.072	10x25	1500	0.061	13x20	1740	0.05
680	10x20	1320	0.065	13x20	1570	0.056	13x25	1930	0.044
820	10x20	1400	0.052	13x20	1700	0.048	13x30	2100	0.039
	10x25	1530	0.052						
1000	13x20	1650	0.045	13x25	1900	0.042	16x25	2300	0.036
1200	13x25	1980	0.041	13x30	2130	0.039	16x31.5	2650	0.036
1500	13x25	2210	0.038	16x25	2270	0.036	16x35.5	2750	0.034
1800	16x25	2510	0.036	16x31.5	2700	0.035	16x35.5	2850	0.034
2200	16x25	2650	0.035	16x31.5	2780	0.034	18x35.5	3040	0.032
2700	16x25	2820	0.031	16x35.5	2850	0.029	18x41	3070	0.027
3300	16x31.5	3240	0.026	18x35.5	3100	0.026	18x41	3100	0.025
4700	16x35.5	3650	0.024	18x41	3500	0.024			
5600	18x35.5	3720	0.024						
6800	18x41	3850	0.024						

ϕ DxL (mm)

Ripple Current (mA, rms) at 105°C 100KHz
 Max Impedance (Ω) at 20°C 100KHz

Radial

φ DxL(mm)

WV Cap(μ F)	63			100			160		
	Size	Ripple	Impedance	Size	Ripple	Impedance	Size	Ripple	Impedance
0.47	5x11	25	5.4	5x11	20	5.9	5x11	36	18.5
1	5x11	33	4	5x11	30	4.4	6.3x11	45	12.0
2.2	5x11	45	2.8	5x11	42	3.3	6.3x11	55	9.9
3.3	5x11	58	2.2	5x11	55	2.8	8x11.5	70	4.31
4.7	5x11	65	2	5x11	72	2.6	8x11.5	80	4.16
5.6	5x11	95	1.9	5x11	100	2.33	10x12.5	91	3.61
6.8	5x11	100	1.82	6.3x11	115	1.95	10x16	100	3.12
10							10x12.5	126	3
	5x11	110	1.75	6.3x11	130	1.77	10x16	140	2.69
22	6.3x11	180	0.80	8x11.5	220	0.85	10x16	205	1.3
33	8x11.5	270	0.61	10x12.5	320	0.69	10x20	260	1.1
47							10x20	276	1.65
	8x11.5	300	0.56	10x12.5	370	0.58	13x20	320	0.91
56	8x11.5	330	0.38	10x12.5	400	0.43	13x20	340	0.67
				10x16	440	0.42	13x25	370	0.66
68	10x12.5	480	0.21	10x16	470	0.35	13x25	450	0.56
100	10x16	610	0.14	10x25	560	0.3	16x25	540	0.47
120	10x16	620	0.13	10x25	660	0.22	16x25	560	0.35
150	10x16	700	0.11	13x20	780	0.174	16x31.5	710	0.26
180	10x20	800	0.10	13x20	820	0.142	16x35.5	760	0.22
220	10x20	920	0.080	13x25	950	0.13	16x35.5	820	0.19
270	13x20	1150	0.065	13x30	1120	0.11	18x35.5	990	0.18
330	13x20	1250	0.055	16x25	1440	0.1	18x41	1180	0.16
470	13x25	1620	0.053	16x31.5	1650	0.09			
560	13x25	1680	0.049	16x35.5	1720	0.085			
680	13x30	1950	0.043	18x35.5	1790	0.08			
820	16x25	2150	0.038	18x35.5	1840	0.071			
1000	16x31.5	2350	0.034	18x41	1930	0.066			
1200	16x35.5	2550	0.032						
1500	18x35.5	2710	0.031						
1800	18x41	3000	0.027						

Ripple Current (mA, rms) at 105°C 100KHz

Max Impedance (Ω) at 20°C 100KHz

φ DxL(mm)

WV Cap(μF)	200			250			350		
	Size	Ripple	Impedance	Size	Ripple	Impedance	Size	Ripple	Impedance
0.47	5x11	36	16.50	5x11	40	8.85	6.3x11	40	8.82
	6.3x11	41	16.50						
1	6.3x11	45	7.76	6.3x11	50	6.54	6.3x11.5	50	7.90
							8x11.5	58	6.35
2.2	6.3x11	55	5.18	8x11.5	72	4.12	8x11.5	75	5.30
							10x12.5	86	4.02
3.3	8x11.5	71	4.25	8x11.5	75	3.85	10x12.5	90	3.80
							10x16	100	3.52
4.7	8x11.5	78	5.00	8x11.5	85	3.50	10x16	118	3.13
	10x12.5	85	4.12	10x12.5	100	2.95	10x20	130	2.77
5.6	8x11.5	90	4.50	8x11.5	95	2.93	10x16	120	2.76
	10x12.5	95	3.55	10x12.5	105	2.72	10x20	132	2.58
6.8	8x16	115	3.25	8x16	124	2.50	10x16	148	2.43
	10x16	140	2.71	10x12.5	126	2.20	10x25	180	1.65
10				10x16	140	1.86			
	8x11.5	115	3.75	8x16	141	1.80	10x16	165	1.64
22	10x16	186	1.80	10x16	190	1.60	13x20	220	1.22
	10x20	205	1.40	10x20	210	1.30			
33	10x20	280	1.00	10x20	224	1.40	13x20	263	1.02
	13x20	330	0.80	10x25	248	1.25	13x25	290	0.86
47				13x20	310	0.90			
	10x20	311	0.72	13x20	375	0.60	16x25	389	0.76
56	13x20	360	0.65	13x25	405	0.45	16x31.5	430	0.62
	13x25	400	0.62						
68	13x20	430	0.45	13x25	420	0.42	16x35.5	460	0.60
	13x25	480	0.42	16x25	490	0.38	16x31.5	475	0.57
100	16x25	540	0.35						
	16x25	780	0.30	16x31.5	675	0.27	16x35.5	481	0.56
120	16x31.5	820	0.28				18x31.5	487	0.56
							18x35.5	513	0.55
150	16x25	740	0.28	16x31.5	692	0.26	18x35.5	525	0.54
	16x31.5	830	0.26	16x35.5	730	0.25	18x41	560	0.52
180	16x31.5	840	0.25	16x35.5	750	0.24	18x41	590	0.50
	16x35.5	860	0.23	18x31.5	750	0.23			
220	18x31.5	920	0.20	18x35.5	830	0.21			
	18x35.5	1050	0.19	18x31.5	850	0.20			
	18x41	1090	0.16	18x41	910	0.19			

WV Cap(μF)	400			420			450		
	Size	Ripple	Impedance	Size	Ripple	Impedance	Size	Ripple	Impedance
0.47	6.3x11	26	33	6.3x11	28	34	8x11.5	30	34
1	8x11.5	36	16.5	8x11.5	38	17	8x11.5	45	17.35
	10x12.5	76	13	10x12.5	58	12.1	10x16	65	10.25
2.2	8x11.5	65	13						
	8x9	78	14						
3.3	8x11.5	86	12	10x12.5	87	11	10x16	89	10
	8x11.5	89	11						
4.7	10x12.5	105	10	10x16	102	8.5	10x20	105	5
	8x16	105	8	10x16	109	6.8	10x20	110	4.75
5.6	10x12.5	120	9						4.6
	10x12.5	144	7.7						
6.8	10x16	160	7.5	10x16	160	6	10x20	135	4.05
	10x14	201	5				10x20	163	7
10	10x16	213	3.8				10x25	180	3.75
	10x20	235	3.6	10x20	180	3.7	13x20	189	6.8
15	10x20	240	3						
	13x16	268	2.8						
22	13x20	295	2.65	13x25	330	2.7	13x25	320	2.8
	13x20	399	1.8						
33	13x25	440	1.6	16x25	480	1.8	16x25	460	2.2
	16x21	459	1.9				18x21	458	2.7
47	16x21	539	1.6				16x35.5	650	1.05
	16x25	580	1.4	16x31.5	620	1.1	18x25	596	1.65
56	16x25	587	1.03						
	16x31.5	650	0.85	16x35.5	670	0.9	18x31.5	730	0.95
68	16x31.5	800	0.8	18x31.5	750	0.8	18x31.5	721	0.8
	18x25	774	0.76				18x35.5	760	0.75
100	18x31.5	854	0.7				18x35.5	825	1.1
	18x35.5	900	1.3	18x35.5	820	0.7	18x41	880	0.74
120	18x35.5	930	1.3				18x41	980	1

Ripple Current (mA, rms) at 105°C 100KHz

Max Impedance (Ω) at 20°C 100KHz

www.amelec.ch

info@amelec.ch

KZ Series Low Impedance

Features

- ◆ Used in communication equipments, switching power supply, industrial measuring instruments, etc.
- ◆ Endurance 1000~2000hrs.
- ◆ Safety vent construction design.
- ◆ RoHS Compliant

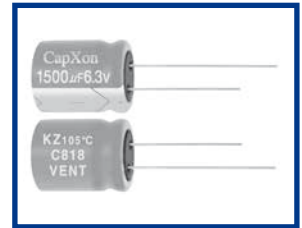

Specifications

Item	Performance Characteristics																					
Operating Temperature Range	-40 to +105°C																					
Rated Voltage Range	6.3 to 50 VDC																					
Capacitance Range	0.47 to 6800 µ F																					
Capacitance Tolerance	±20%(120Hz,+20°C)																					
Leakage Current (+20°C,max.)	$I \leq 0.01 CV$ or $3 (\mu A)$ After 2 minutes whichever is greater measured with rated working voltage applied.																					
Dissipation Factor ($\tan \delta$, at 20°C , 120Hz)	<table border="1"> <tr> <th>Working Voltage(VDC)</th> <th>6.3</th> <th>10</th> <th>16</th> <th>25</th> <th>35</th> <th>50</th> </tr> <tr> <th>D.F. (%)max.</th> <td>18</td> <td>16</td> <td>14</td> <td>12</td> <td>10</td> <td>9</td> </tr> </table>	Working Voltage(VDC)	6.3	10	16	25	35	50	D.F. (%)max.	18	16	14	12	10	9							
	Working Voltage(VDC)	6.3	10	16	25	35	50															
D.F. (%)max.	18	16	14	12	10	9																
For capacitance > 1000 µ F, add 2% per another 1000uF.																						
Low Temperature Characteristics (at 120Hz)	Impedance ratio max																					
	<table border="1"> <tr> <th>Working Voltage(VDC)</th> <th>6.3</th> <th>10</th> <th>16</th> <th>25</th> <th>35</th> <th>50</th> </tr> <tr> <th>Z-25°C / Z+20°C</th> <td>4</td> <td>3</td> <td>3</td> <td>3</td> <td>3</td> <td>3</td> </tr> <tr> <th>Z-40°C / Z+20°C</th> <td>8</td> <td>6</td> <td>4</td> <td>3</td> <td>3</td> <td>3</td> </tr> </table>	Working Voltage(VDC)	6.3	10	16	25	35	50	Z-25°C / Z+20°C	4	3	3	3	3	3	Z-40°C / Z+20°C	8	6	4	3	3	3
	Working Voltage(VDC)	6.3	10	16	25	35	50															
Z-25°C / Z+20°C	4	3	3	3	3	3																
Z-40°C / Z+20°C	8	6	4	3	3	3																
For capacitance > 1000 µ F, add 0.5 per another 1000uF for -25°C / +20°C add 1 per another 1000uF for -40°C / +20°C																						
Endurance	Test conditions Duration time : as right Ambient temperature : +105°C Applied voltage : Rated DC working voltage																					
	<table border="1"> <tr> <th>D φ</th> <th>Life hours</th> </tr> <tr> <td>5 - 6.3 φ</td> <td>1000</td> </tr> <tr> <td>≥ 8 φ</td> <td>2000</td> </tr> </table>	D φ	Life hours	5 - 6.3 φ	1000	≥ 8 φ	2000															
D φ	Life hours																					
5 - 6.3 φ	1000																					
≥ 8 φ	2000																					
Shelf Life	After test requirement at +20°C Capacitance change : ≤ ±20% of the initial measured value Dissipation factor : ≤ 200% of the initial specified value Leakage current : ≤ The initial specified value																					
	Test conditions Duration time : 1000Hrs Ambient temperature : +105°C Applied voltage : None After test requirement at +20°C: Same limits as Endurance. Pre-treatment for measurements shall be conducted after application of DC working voltage for 30 minutes.																					

Multiplier for Ripple Current vs. Frequency

CAP (µ F) \ Frequency(Hz)	50(60)	120	400	1K	10K	50K-100K
CAP ≤ 10	0.47	0.59	0.76	0.85	0.97	1
10 < CAP ≤ 100	0.52	0.62	0.80	0.89	0.97	1
100 < CAP ≤ 1000	0.58	0.72	0.84	0.90	0.98	1
1000 < CAP	0.63	0.78	0.87	0.91	0.98	1

Diagram of Dimensions:(unit:mm)

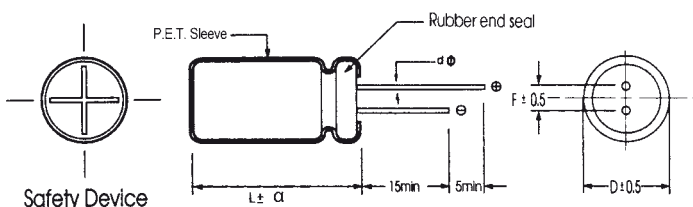

D φ	5	6.3	8		10	13	16	18
F	2.0	2.5	3.5		5.0	5.0	7.5	7.5
d φ	0.5		L < 20 0.5	L ≥ 20 0.6	0.6		0.8	

α	D < 18	D = 18		D > 18
		L < 35.5	L ≥ 35.5	
	1.5	1.5	2.0	2.0

Case Size

φ DxL(mm)

WV Cap(μ F)	6.3			10			16		
	Size	Ripple	Impedance	Size	Ripple	Impedance	Size	Ripple	Impedance
10							5x11	80	4
22	5x11	80	3	5x11	90	2.5	5x11	110	2.0
33	5x11	90	2.0	5x11	105	2.0	5x11	114	1.8
47	5x11	140	1.5	5x11	155	1.3	5x11	160	1.0
56	5x11	150	1.5	5x11	165	1.2	5x11	180	0.8
68	5x11	160	1.1	5x11	175	1.0	5x11	200	0.65
100	5x11	170	1.0	5x11	215	0.75	5x11	255	0.55
120	5x11	173	0.9	6.3x11	240	0.73	6.3x11	270	0.45
150	5x11	178	0.85	6.3x11	225	0.60	6.3x11	292	0.40
180	6.3x11	215	0.72	6.3x11	280	0.58	6.3x11	380	0.32
220	6.3x11	295	0.62	6.3x11	300	0.43	6.3x11	430	0.25
270	6.3x11	320	0.50	8x11.5	405	0.28	8x11.5	480	0.20
330	6.3x11	380	0.45	8x11.5	465	0.25	8x11.5	595	0.15
470	8x11.5	460	0.22	8x11.5	500	0.22	8x11.5	650	0.15
560	8x11.5	490	0.22	8x11.5	620	0.17	8x11.5	730	0.12
680	8x11.5	520	0.19	8x11.5	750	0.12	10x12.5	890	0.09
820	8x11.5	605	0.19	10x12.5	805	0.10	10x12.5	980	0.085
1000	8x11.5	680	0.18	10x12.5	1050	0.08	10x16	1180	0.07
1200	10x12.5	750	0.15	10x16	1150	0.065	10x20	1320	0.06
1500	10x12.5	820	0.14	10x16	1210	0.062	10x20	1450	0.056
1800	10x16	920	0.12	10x20	1280	0.06	10x20	1510	0.053
2200	10x20	1150	0.10	10x20	1520	0.05	13x20	1820	0.04
2700	10x20	1500	0.075	13x20	1580	0.048	13x20	2050	0.035
3300	10x20	1620	0.06	13x20	1700	0.043	13x25	2300	0.033
3900	13x25	1820	0.058	13x25	1860	0.040	16x25	2550	0.033
4700	13x25	1920	0.04	13x25	1950	0.038	16x25	2580	0.032
5600	13x30	2210	0.038	16x25	2290	0.033	16x31.5	2650	0.030
6800	16x25	2380	0.032	16x25	2480	0.028	16x31.5	2900	0.024

Ripple Current (mA, rms) at 105°C 100KHz

Max Impedance (Ω) at 20°C 100KHz

Radial

WV Cap(μ F)	25			35			50		
	Size	Ripple	Impedance	Size	Ripple	Impedance	Size	Ripple	Impedance
0.47							5x11	28	5.0
1							5x11	42	3.8
2.2							5x11	55	2.8
3.3							5x11	62	2.0
4.7	5x11	72	3.5	5x11	87	3.5	5x11	90	2.0
5.6	5x11	75	3.5	5x11	95	3.0	5x11	108	1.8
6.8	5x11	83	2.8	5x11	98	2.7	5x11	112	1.8
10	5x11	87	2.5	5x11	107	2.2	5x11	120	1.75
22	5x11	118	1.8	5x11	150	1.5	5x11	150	1.5
33	5x11	155	1.4	5x11	180	1.2	6.3x11	233	0.78
47	5x11	183	0.9	5x11	257	0.75	6.3x11	270	0.65
56	5x11	207	0.83	6.3x11	283	0.6	6.3x11	290	0.6
68	5x11	210	0.69	6.3x11	290	0.55	6.3x11	310	0.5
100	6.3x11	378	0.34	6.3x11	430	0.26	8x11.5	480	0.17
120	6.3x11	380	0.33	8x11.5	470	0.20	10x12.5	500	0.1638
150	8x11.5	390	0.325	8x11.5	510	0.2	10x12.5	560	0.16
180	8x11.5	430	0.25	8x11.5	570	0.18	10x12.5	580	0.14
220	8x11.5	550	0.15	8x11.5	620	0.13	10x16	640	0.09
270	8x11.5	620	0.15	10x12.5	850	0.12	10x16	905	0.08
330	8x11.5	710	0.13	8x16	1050	0.08	10x16	1050	0.07
470	8x11.5	980	0.078	10x16	1100	0.065	13x20	1450	0.05
	8x16	1050	0.07						
560	10x16	1080	0.065	13x20	1300	0.06	13x20	1510	0.05
680	10x16	1100	0.065	13x20	1570	0.056	13x20	1750	0.05
820	10x20	1350	0.05	13x20	1700	0.048	13x25	1980	0.04
1000	10x20	1580	0.045	13x20	1820	0.042	13x25	2000	0.04
1200	13x20	1720	0.04	13x25	2130	0.038	16x25	2200	0.038
1500	13x20	1780	0.04	13x25	2150	0.038	16x25	2300	0.038
1800	13x20	1980	0.035	13x25	2450	0.035	16x31.5	2610	0.036
2200	13x25	2000	0.033	16x25	2650	0.034	16x31.5	2900	0.033
2700	13x25	2250	0.032	16x31.5	2690	0.030	18x35.5	3000	0.028
3300	16x25	2580	0.027	16x35.5	2750	0.027	18x35.5	3050	0.026
4700	16x31.5	2850	0.025	18x35.5	2940	0.025			
5600	16x35.5	3000	0.025	18x35.5	3050	0.024			
6800	18x35.5	3550	0.025						

Ripple Current (mA, rms) at 105°C 100KHz

Max Impedance (Ω) at 20°C 100KHz

GF Series Low Impedance

Features

- ◆ Used in mother board, computer peripheral, etc.
- ◆ Endurance 2000 ~ 5000 Hrs at 105 °C
- ◆ Safety vent construction design.
- ◆ RoHS Compliant

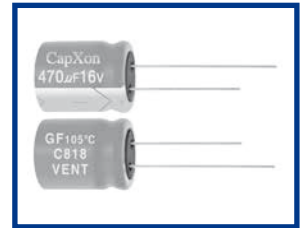

Specifications

Item	Performance Characteristics																											
Operating Temperature Range	-55 to +105°C																											
Rated Voltage Range	6.3 to 100 VDC																											
Capacitance Range	4.7 to 6800 µF																											
Capacitance Tolerance	±20% (120Hz, +20°C)																											
Leakage Current (+20°C,max.)	I ≤ 0.01 CV or 3 (µA) After 2 minutes whichever is greater measured with rated working voltage applied.																											
Dissipation Factor (tan δ , at 20°C , 120Hz)	<table border="1"> <tr> <th>Working Voltage (VDC)</th> <td>6.3</td> <td>10</td> <td>16</td> <td>25</td> <td>35</td> <td>50</td> <td>63</td> <td>100</td> </tr> <tr> <th>D.F. (%)max</th> <td>16</td> <td>14</td> <td>12</td> <td>10</td> <td>9</td> <td>8</td> <td>8</td> <td>8</td> </tr> </table> <p>For capacitance > 1000 µF, add 2% per another 1000 µF.</p>	Working Voltage (VDC)	6.3	10	16	25	35	50	63	100	D.F. (%)max	16	14	12	10	9	8	8	8									
Working Voltage (VDC)	6.3	10	16	25	35	50	63	100																				
D.F. (%)max	16	14	12	10	9	8	8	8																				
Low Temperature Characteristics (at 120Hz)	<p>Impedance ratio max</p> <table border="1"> <tr> <th>Working Voltage</th> <td>6.3</td> <td>10</td> <td>16</td> <td>25</td> <td>35</td> <td>50</td> <td>63</td> <td>100</td> </tr> <tr> <th>Z(-25°C) / Z(20°C)</th> <td>4</td> <td>3</td> <td>3</td> <td>3</td> <td>3</td> <td>3</td> <td>2</td> <td>2</td> </tr> <tr> <th>Z(-40°C) / Z(20°C)</th> <td>8</td> <td>6</td> <td>4</td> <td>3</td> <td>3</td> <td>3</td> <td>3</td> <td>3</td> </tr> </table> <p>For Capacitance > 1000 µF, add 0.5 per another 1000 µF for -25°C/+20°C add 1 per another 1000 µF for -40°C/+20°C</p>	Working Voltage	6.3	10	16	25	35	50	63	100	Z(-25°C) / Z(20°C)	4	3	3	3	3	3	2	2	Z(-40°C) / Z(20°C)	8	6	4	3	3	3	3	3
Working Voltage	6.3	10	16	25	35	50	63	100																				
Z(-25°C) / Z(20°C)	4	3	3	3	3	3	2	2																				
Z(-40°C) / Z(20°C)	8	6	4	3	3	3	3	3																				
Endurance	<p>Test conditions</p> <p>Duration time :as right Ambient temperature :+105°C Applied voltage :Rated DC working voltage</p> <table border="1"> <tr> <th>D φ</th> <th>Life hours</th> </tr> <tr> <td>5 - 6.3 φ</td> <td>2000</td> </tr> <tr> <td>8 φ</td> <td>3000</td> </tr> <tr> <td>≥ 10 φ</td> <td>5000</td> </tr> </table> <p>After test requirement at +20°C</p> <p>Capacitance change :≤ ±20% of the initial measured value Dissipation factor :≤ 200% of the initial specified value Leakage current :≤ The initial specified value</p>	D φ	Life hours	5 - 6.3 φ	2000	8 φ	3000	≥ 10 φ	5000																			
D φ	Life hours																											
5 - 6.3 φ	2000																											
8 φ	3000																											
≥ 10 φ	5000																											
Shelf Life	<p>Test conditions</p> <p>Duration time :1000Hrs Ambient temperature :+105°C Applied voltage :None</p> <p>After test requirement at +20°C:Same limits as Endurance. Pre-treatment for measurements shall be conducted after application of DC working voltage for 30 minutes.</p>																											

Multiplier for Ripple Current vs. Frequency

CAP(µF)\Frequency(Hz)	50(60)	120	400	1K	10K	50K-100K
CAP ≤ 10	0.47	0.59	0.76	0.85	0.97	1.0
10 < CAP ≤ 100	0.52	0.62	0.80	0.89	0.97	1.0
100 < CAP ≤ 1000	0.58	0.72	0.84	0.90	0.98	1.0
1000 < CAP	0.63	0.78	0.87	0.91	0.98	1.0

Diagram of Dimensions:(unit:mm)

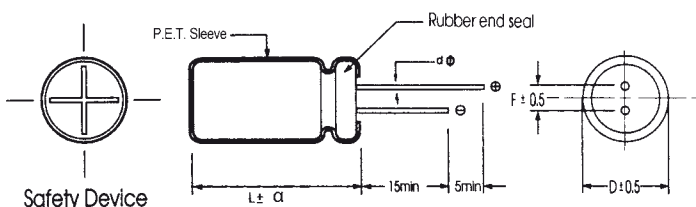

D φ	5	6.3	8	10	13	16	18
F	2.0	2.5	3.5	5.0	5.0	7.5	7.5
d φ	0.5		L < 20 0.5	L ≥ 20 0.6	0.6		0.8
α	D < 18	D = 18		D > 18			
	1.5	L < 35.5	L ≥ 35.5	2.0		2.0	

Case Size

WV Cap(μF)	6.3				10				φ DxL(mm)
	Size	Ripple	Impedance		Size	Ripple	Impedance		
			+20°C	-10°C			+20°C	-10°C	
68					5x11	190	0.70	2.065	
82					5x11	210	0.50	1.475	
100	5x11	200	0.40	1.240	5x11	242	0.31	0.915	
120	5x11	210	0.38	1.178	5x11	261	0.28	0.826	
150	5x11	225	0.35	1.085	6.3x11	300	0.26	0.767	
180	6.3x11	300	0.32	0.992	6.3x11	350	0.22	0.649	
220	6.3x11	360	0.25	0.775	6.3x11	390	0.18	0.531	
270	6.3x11	377	0.24	0.744	6.3x15	460	0.16	0.472	
330	6.3x11	395	0.20	0.465	8x11.5	540	0.11	0.325	
390	8x11.5	576	0.14	0.434	8x11.5	620	0.095	0.280	
470	8x11.5	600	0.095	0.294	8x11.5	750	0.075	0.221	
560	8x16	720	0.087	0.270	8x16	870	0.072	0.212	
680	8x16	800	0.080	0.248	8x20	1010	0.068	0.201	
	10x16	814	0.084	0.260					
820	8x20	970	0.070	0.217	8x20	1030	0.065	0.192	
1000	10x12.5	1000	0.055	0.168	8x20	1220	0.050	0.148	
					10x16	1400	0.042	0.124	
					10x20	1560	0.035	0.095	
1200	8x20	1150	0.048	0.146					
	10x16	1180	0.050	0.152					
1500	10x20	1400	0.045	0.137	10x20	1670	0.032	0.086	
	10x25	1560	0.043	0.131					
1800	10x20	1500	0.041	0.125	10x25	2000	0.028	0.076	
2200	10x25	1720	0.037	0.113	13x20	2370	0.025	0.065	
	13x20	1890	0.039	0.119					
2700	13x20	2080	0.034	0.095	13x20	2400	0.023	0.060	
3300	13x20	2290	0.026	0.073	13x25	2720	0.021	0.055	
3900	10x30	2450	0.024	0.067	13x30	3000	0.020	0.052	
	13x25	2670	0.022	0.062					
4700	13x30	3200	0.021	0.059	13x35	3450	0.019	0.049	
5600	13x35	3270	0.020	0.056	16x31.5	3460	0.018	0.047	
6800	16x31.5	3490	0.018	0.050	16x31.5	3630	0.016	0.042	

Ripple Current (mA, rms) at 105°C 100KHz

Max Impedance (Ω) at 20°C 100KHz

φ pDxL(mm)

WV Cap(μF)	16				25			
	Size	Ripple	Impedance		Size	Ripple	Impedance	
			+20°C	-10°C			+20°C	-10°C
39					5x11	210	0.42	1.218
47	5x11	200	0.40	1.16	5x11	240	0.35	1.015
56	5x11	220	0.38	1.10	5x11	256	0.31	0.899
68	5x11	230	0.35	1.02	6.3x11	300	0.28	0.812
82	5x11	260	0.31	0.90	6.3x11	350	0.24	0.696
100	6.3x11	360	0.25	0.73	6.3x11	410	0.15	0.435
120	6.3x11	365	0.23	0.67	6.3x15	490	0.13	0.377
150	6.3x11	385	0.21	0.61	8x11.5	540	0.11	0.319
180	8x11.5	520	0.19	0.55	8x11.5	620	0.098	0.2842
220	8x11.5	575	0.14	0.41	8x11.5	750	0.075	0.218
270	8x11.5	600	0.12	0.35	8x16	850	0.063	0.183
330	8x11.5	740	0.08	0.23	8x16	990	0.056	0.1624
					10x12.5	1010	0.054	0.1566
390	8x16	790	0.075	0.22	10x12.5	1050	0.051	0.1479
470	8x16	990	0.062	0.18	8x20	1260	0.045	0.1305
	10x12.5	1000	0.058	0.17	10x16	1415	0.042	0.1218
560	8x20	1070	0.057	0.17	10x20	1450	0.040	0.116
680	8x20	1120	0.055	0.16	10x20	1570	0.035	0.1015
	10x16	1280	0.052	0.15				
820	10x20	1400	0.048	0.14	10x25	1910	0.032	0.093
1000	10x20	1840	0.035	0.09	13x20	2340	0.025	0.055
1200	10x25	1920	0.032	0.08	13x20	2390	0.025	0.055
1500	10x25	2050	0.030	0.08	13x25	2710	0.023	0.0506
	13x20	2200	0.029	0.07				
1800	13x20	2380	0.026	0.07	13x30	3150	0.021	0.0462
2200	13x25	2750	0.022	0.06	13x35	3420	0.018	0.0396
2700	13x25	3000	0.022	0.06	16x31.5	3480	0.018	0.0396
3300	13x35	3490	0.018	0.05	16x31.5	3600	0.018	0.0396
3900	16x25	3520	0.018	0.05				
4700	16x31.5	3770	0.017	0.04				

Ripple Current (mA, rms) at 105°C 100KHz
 Max Impedance (Ω) at 20°C 100KHz

φ DxDL(mm)

WV Cap(μF)	35				50			
	Size	Ripple	Impedance		Size	Ripple	Impedance	
			+20°C	-10°C			+20°C	-10°C
22					5x11	220	0.35	1.015
27					6.3x11	265	0.34	0.986
33	5x11	230	0.32	0.934	6.3x11	280	0.32	0.928
39	6.3x11	277	0.31	0.905	6.3x11	300	0.28	0.812
47	6.3x11	340	0.20	0.584	8x11.5	360	0.20	0.580
56	6.3x11	375	0.20	0.584	8x11.5	385	0.19	0.551
68	6.3x11	400	0.19	0.555	8x11.5	400	0.17	0.493
82	8x11.5	480	0.17	0.496	8x11.5	550	0.12	0.348
100	8x11.5	560	0.15	0.438	8x11.5	730	0.075	0.2175
120	8x11.5	585	0.13	0.38	8x16	770	0.073	0.2117
					10x12.5	790	0.072	0.2088
150	8x11.5	680	0.11	0.321	10x12.5	870	0.068	0.1972
180	8x16	810	0.098	0.286	8x20	1060	0.055	0.1595
					10x16	1090	0.055	0.1595
220	8x16	1000	0.056	0.164	10x16	1385	0.045	0.1305
	10x12.5	1060	0.052	0.152				
270	10x16	1190	0.050	0.146	10x20	1500	0.043	0.1247
330	8x20	1210	0.041	0.12	10x25	1850	0.032	0.0928
	10x16	1400	0.038	0.111				
390	10x20	1550	0.035	0.102	13x20	1910	0.031	0.0899
470	10x20	1850	0.034	0.064	13x20	2000	0.030	0.0870
560	10x25	2040	0.031	0.064	13x20	2150	0.028	0.0812
680	13x20	2260	0.029	0.061	13x25	2490	0.026	0.0754
	13x25	2630	0.021	0.053	13x30	2770	0.025	0.0725
820					16x25	2960	0.024	0.0696
1000	13x25	2780	0.019	0.048	16x25	3000	0.020	0.0580
1200	13x30	2950	0.019	0.048				
	16x25	3150	0.018	0.045				
1500	13x35	3350	0.018	0.045				
	16x31.5	3600	0.017	0.043				
1800	16x31.5	3670	0.016	0.04				
2200	16x35.5	3750	0.015	0.038				
2700	18x31.5	3850	0.014	0.035				

Ripple Current (mA, rms) at 105°C 100KHz

Max Impedance (Ω) at 20°C 100KHz

φ DxL(mm)

WV Cap(μF)	63				100			
	Size	Ripple	Impedance		Size	Ripple	Impedance	
			+20°C	-10°C			+20°C	-10°C
4.7					5x11	105	1.60	4.64
5.6					5x11	116	1.49	4.321
6.8					5x11	120	1.45	4.205
10	5x11	135	0.95	2.755	6.3x11	170	0.70	2.03
15	6.3x11	168	0.85	2.465	8x11.5	255	0.61	1.769
18	6.3x11	170	0.82	2.378	8x11.5	270	0.56	1.624
22	6.3x11	250	0.75	2.175	8x11.5	320	0.48	1.392
27	6.3x11	260	0.55	1.595	8x11.5	340	0.39	1.131
33	6.3x11	270	0.38	1.102	8x16	400	0.31	0.899
39	8x11.5	320	0.35	1.015	8x16	425	0.29	0.841
					10x12.5	440	0.27	0.783
47	8x11.5	400	0.22	0.638	10x12.5	450	0.25	0.725
56	8x11.5	420	0.22	0.638	10x16	540	0.21	0.609
68	10x12.5	500	0.20	0.58	10x20	630	0.18	0.522
82	8x16	540	0.17	0.493	10x20	720	0.15	0.435
	10x12.5	570	0.16	0.464				
100	10x12.5	720	0.14	0.406	10x25	890	0.12	0.348
120	8x20	790	0.14	0.406	10x25	900	0.12	0.348
	10x16	835	0.13	0.377	13x20	980	0.11	0.319
150	10x16	900	0.11	0.319	13x20	1100	0.095	0.276
180	10x20	1200	0.095	0.276	13x25	1250	0.078	0.226
220	10x25	1315	0.075	0.218	13x30	1420	0.065	0.189
					16x21	1270	0.075	0.218
270	13x20	1400	0.071	0.206	13x35	1630	0.057	0.165
					16x25	1570	0.058	0.168
330	10x30	1750	0.047	0.136	13x40	1650	0.045	0.131
	13x25	1870	0.045	0.131				
390	13x25	1920	0.044	0.128	16x31.5	1850	0.043	0.125
470	13x30	2225	0.041	0.119	16x35.5	1900	0.032	0.093
	16x21	1970	0.043	0.125	18x31.5	1700	0.038	0.095
560	16x25	2350	0.039	0.098	16x41	2170	0.032	0.08
					18x31.5	2100	0.031	0.078
680	16x31.5	2600	0.035	0.088	18x35.5	2400	0.029	0.073
820	16x31.5	2650	0.031	0.078				
1000	16x35.5	2780	0.026	0.065				
	18x31.5	3230	0.028	0.070				

Ripple Current (mA, rms) at 105°C 100KHz
 Max Impedance (Ω) at 20°C 100KHz

Radial

LZ Series Ultra Low Impedance

Features

- ◆ Ultra low impedance in 100KHz.
- ◆ Allow higher ripple current applied due to ultra low impedance.
- ◆ Endurance 2000hrs at 105°C
- ◆ Suitable for application of mother board, computer peripheral etc.
- ◆ RoHS Compliant

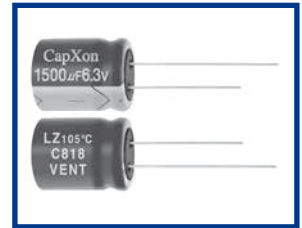

Specifications

Item	Performance Characteristics								
Operating Temperature Range	-40 ~ +105°C								
Rated Voltage Range	6.3 ~ 25V with rate working voltage applied								
Capacitance Range	220 to 3300 µ F								
Capacitance Tolerance	±20% (20°C, 120Hz)								
Leakage Current (+20°C,max.)	I ≤ 0.01CV or 3 µ A After 2 minutes whichever is greater measured								
Dissipation Factor (tan δ , at 20°C , 120Hz)	Rated Voltage(V)	6.3	10	16	25				
	D.F. (%) max	14	12	10	9				
For capacitance > 1000 µ F, add 2% per another 1000 µ F									
Low Temperature Characteristics (at 120Hz)	Impedance ratio max								
	Rated Voltage(V)	6.3	10	16	25				
	Z-25°C / Z+20°C	4	3	2	2				
Z-40°C / Z+20°C						6	4	3	3
For Capacitance Value > 1000 µ F, add 0.5 per another 1000 µ F for -25°C / +20°C add 1 per another 1000 µ F for -40°C / +20°C									
Endurance	Test Conditions Duration : 2000 hrs Ambient temperature : +105°C Applied voltage : Rated DC working voltage After test requirement at +20°C Capacitance change : Within ±25% of the initial measured value Dissipation factor : Not exceed 200% of the initial specified value Leakage current : Not exceed the specified value								
Shelf Life	Test Conditions Duration : 1000 hrs Ambient temperature : +105°C After test requirement at +20°C Capacitance change : Within ±25% of the initial measured value Dissipation factor : Not exceed 200% of the initial specified value Leakage current : Not exceed the specified value								

Multiplier for Ripple Current vs. Frequency

CAP(µ F) \ Frequency(Hz)	120Hz	1KHz	10KHz	100KHz
100 ~ 330 µ F	0.40	0.75	0.93	1.00
390 ~ 1000 µ F	0.50	0.85	0.95	1.00
1200 ~ 3300 µ F	0.55	0.90	0.98	1.00

Diagram of Dimensions:(unit:mm)

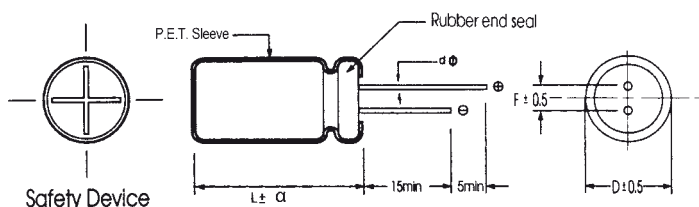

D φ	8	10	
F	3.5	5.0	
d φ	L < 20 0.5	L ≥ 20 0.6	0.6

α	D < 18	D = 18		D > 18
		L < 35.5	L ≥ 35.5	
	1.5	1.5	2.0	2.0

Case Size

φ DxL(mm)

WV Cap(μF)	6.3			10			16		
	Size	Ripple	Impedance	Size	Ripple	Impedance	Size	Ripple	Impedance
330							8X11.5	1080	0.038
470				8X11.5	1080	0.038	8X11.5	1080	0.038
							10X12.5	1500	0.027
560	8x11.5	1080	0.038	8X11.5	1080	0.038	8X16	1450	0.029
680	8x11.5	1080	0.038	8X11.5	1080	0.038	8X16	1450	0.029
				10X12.5	1500	0.027	10X12.5	1500	0.027
820	8x11.5	1080	0.038	10X12.5	1450	0.029	8X20	1850	0.020
1000	8x16	1100	0.036	8X16	1450	0.029	8X20	1850	0.020
	10x12.5	1500	0.027	10X12.5	1500	0.027	10X16	1910	0.018
1200	8x16	1450	0.029	8X20	1850	0.020	10X20	2540	0.017
1500	8x20	1850	0.020	8X20	1850	0.020	10X20	2540	0.015
	10x12.5	1500	0.027	10X16	1910	0.018			
1800	10x16	1910	0.018	10X20	2540	0.016	10X25	2800	0.013
2200	8x20	1850	0.020	10X20	2540	0.015			
	10x16	1910	0.018	10X25	2800	0.014			
2700	10x20	2540	0.013						
3300	10x30	2800	0.012						

WV Cap(μF)	25		
	Size	Ripple	Impedance
220	8X11.5	1080	0.032
270	8X11.5	1150	0.031
330	8X11.5	1450	0.029
	10X12.5	1850	0.027
470	8X20	1720	0.020
	10X12.5	1440	0.025
	10X16	1830	0.022
560	10X16	1850	0.021
680	8X20	1820	0.018
	10X16	1920	0.020
	10X20	2060	0.018
1000	10X20	2180	0.016

Ripple Current (mA, rms) at 105°C 100KHz
 Max ESR (Ω) at 20°C 100KHz

GH Series

Features

- ◆ Low impedance
- ◆ High temperature, Long life 3,000 to 10,000 hours at 105°C

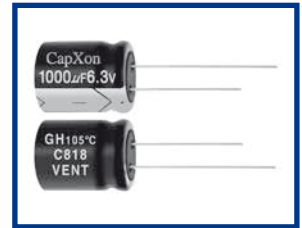

Specifications

Item	Performance Characteristics																												
Operating Temperature Range	-55 to +105°C																												
Rated Voltage Range	6.3 to 50 VDC																												
Capacitance Range	0.47 to 6800 µ F																												
Capacitance Tolerance	±20%(120Hz,+20°C)																												
Leakage Current (+20°C,max.)	$I \leq 0.01 CV$ or 3 (µ A) (After 2 minute with rated working voltage applied.)																												
Dissipation Factor (tan δ , at 20°C , 120Hz)	<table border="1"> <tr> <td>Working Voltage(VDC)</td> <td>6.3</td> <td>10</td> <td>16</td> <td>25</td> <td>35</td> <td>50</td> </tr> <tr> <td>D.F.(%)max.</td> <td>22</td> <td>19</td> <td>16</td> <td>14</td> <td>12</td> <td>10</td> </tr> </table>	Working Voltage(VDC)	6.3	10	16	25	35	50	D.F.(%)max.	22	19	16	14	12	10														
	Working Voltage(VDC)	6.3	10	16	25	35	50																						
D.F.(%)max.	22	19	16	14	12	10																							
For capacitance > 1000 µ F,add 2% per another 1000 µ F.																													
Low Temperature Characteristics (at 120Hz)	Impedance ratio max																												
	<table border="1"> <tr> <td>Rated voltage(VDC)</td> <td>6.3</td> <td>10</td> <td>16</td> <td>25</td> <td>35</td> <td>50</td> </tr> <tr> <td>Z-25°C / Z+20°C</td> <td>4</td> <td>3</td> <td>2</td> <td>2</td> <td>1.5</td> <td>1.5</td> </tr> <tr> <td>Z-40°C / Z+20°C</td> <td>6</td> <td>4</td> <td>3</td> <td>3</td> <td>2</td> <td>2</td> </tr> <tr> <td>Z-55°C / Z+20°C</td> <td>8</td> <td>6</td> <td>5</td> <td>5</td> <td>4</td> <td>4</td> </tr> </table>	Rated voltage(VDC)	6.3	10	16	25	35	50	Z-25°C / Z+20°C	4	3	2	2	1.5	1.5	Z-40°C / Z+20°C	6	4	3	3	2	2	Z-55°C / Z+20°C	8	6	5	5	4	4
	Rated voltage(VDC)	6.3	10	16	25	35	50																						
	Z-25°C / Z+20°C	4	3	2	2	1.5	1.5																						
Z-40°C / Z+20°C	6	4	3	3	2	2																							
Z-55°C / Z+20°C	8	6	5	5	4	4																							
For Capacitance > 1000 µ F, add 0.5 per another 1000 µ F for -25°C/+20°C add 1 per another 1000 µ F for -40°C/+20°C add 1.5 per another 1000 µ F for -55°C/+20°C																													
Endurance	Test condition Duration time:																												
	<table border="1"> <tr> <td>D φ</td> <td>5-6.3 φ</td> <td>8-12 φ</td> <td>≥13 φ</td> </tr> <tr> <td>+105°C Life hours</td> <td>4000 hours</td> <td>7000 hours</td> <td>10000 hours</td> </tr> </table>	D φ	5-6.3 φ	8-12 φ	≥13 φ	+105°C Life hours	4000 hours	7000 hours	10000 hours																				
	D φ	5-6.3 φ	8-12 φ	≥13 φ																									
	+105°C Life hours	4000 hours	7000 hours	10000 hours																									
	* down size Endurance																												
<table border="1"> <tr> <td>D φ</td> <td>5-6.3 φ</td> <td>8 φ</td> <td>10-12.5 φ</td> <td>≥13 φ</td> </tr> <tr> <td>+105°C</td> <td>3000 hours</td> <td>4000 hours</td> <td>6000 hours</td> <td>7000 hours</td> </tr> </table>	D φ	5-6.3 φ	8 φ	10-12.5 φ	≥13 φ	+105°C	3000 hours	4000 hours	6000 hours	7000 hours																			
D φ	5-6.3 φ	8 φ	10-12.5 φ	≥13 φ																									
+105°C	3000 hours	4000 hours	6000 hours	7000 hours																									
Ambient temperature :+105°C Applied voltage :Rated DC working voltage After test requirement at +20°C Capacitance change :≤ ±25% of the initial measured value Dissipation factor :≤200% of the initial specified value Leakage current :≤The initial specified value																													
Shelf Life	Test condition Duration time :1000 Hrs Ambient temperature :+105°C Applied voltage :None After test requirement at +20°C:Same limits as Endurance. Pre-treatment for measurements shall be conducted after application of DC working voltage for 30 minutes.																												

Multiplier for Ripple Current vs. Frequency

CAP(µ F)\Frequency(Hz)	120	400	1K	10K	100K
CAP≤10	0.40	0.52	0.60	0.92	1
10<CAP≤100	0.67	0.80	0.83	0.94	1
100<CAP≤1000	0.75	0.84	0.88	0.95	1
1000<CAP	0.82	0.87	0.92	0.95	1

Diagram of Dimensions:(unit:mm)

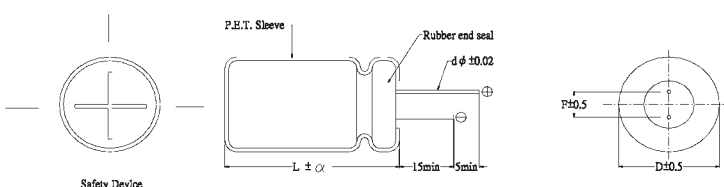

D φ	5	6.3	8	10	13	16	18
F	2.0	2.5	3.5	5.0	5.0	7.5	7.5
d φ	0.5		$L < 20$ 0.5	$L \geq 20$ 0.6	0.6		0.8

α	D < 18	D = 18		D > 18
	1.5	L < 35.5	L ≥ 35.5	2.0
		1.5	2.0	

Case Size

φ DxDL (mm)

WV Cap(μF)	6.3			10			16		
	Size	Ripple	Impedance	Size	Ripple	Impedance	Size	Ripple	Impedance
10							5X11	36	3.9
15							5X11	72	3.32
22				5X11	66	3.08	5X11	72	2.64
27				5X11	72	2.67	5X11	132	2.37
33				5X11	72	2.33	5X11	144	2
39				5X11	120	2.02	5X11	168	1.61
47				5X11	132	1.71	5X11	186	1.35
56				5X11	144	1.47	5X11	210	1.24
68				5X11	162	1.3	5X11	228	1.18
82	5X11	198	1.63	5X11	192	1.15	6.3X11	264	1.03
100	5X11	210	1.45	5X11	222	1.02	6.3X11	264	0.86
				6.3X11	240	1.02	5X11*	228	1.1
120	5X11	222	1.28	5X11*	246	1.02	6.3X11	312	0.66
				6.3X11	258	1.02			
150	6.3X11	240	1.16	6.3X11	282	0.95	6.3X11*	336	0.58
							6.3X15	396	0.58
180	6.3X11	282	1.04	6.3X11	318	0.68	6.3X15	420	0.56
							8X11.5	426	0.54
220	6.3X11	378	0.89	6.3X11*	366	0.60	6.3X15	504	0.52
				6.3X15	390	0.58	8X11.5	540	0.46
270	6.3X11	396	0.77	6.3X15	414	0.56	6.3X15*	540	0.42
				8X11.5	420	0.53	8X11.5	582	0.38
330	6.3X11*	378	0.77	6.3X15	462	0.47	8X11.5*	588	0.37
	6.3X15	426	0.68	8X11.5	492	0.45	8X16	618	0.35
390	8X11.5	444	0.68				6.3X15*	588	0.14
	6.3X15*	462	0.58	6.3X15*	456	0.42	8X11.5*	612	0.33
470	8X11.5	480	0.52	8X11.5	516	0.42	8X16	654	0.33
							10X12.5	648	0.33
560	6.3X15	504	0.41	6.3X15*	480	0.37	8X16*	846	0.29
	8X11.5	534	0.38	8X11.5	552	0.30	8X20	900	0.28
680	10X12.5	564	0.38				10X12.5	882	0.28
	8X11.5*	570	0.36	8X11.5*	588	0.28	8X16*	864	0.26
820	8X16	600	0.36	8X16	636	0.25	8X20	936	0.24
	10X12.5	612	0.36	10X12.5	636	0.25	10X12.5*	882	0.24
1000							10X16	960	0.20
	8X11.5*	582	0.33	8X16	660	0.21	8X20*	960	0.20
1200	8X16	618	0.33	8X20	684	0.20	10X16	1044	0.18
	10X12.5	642	0.33	10X12.5	684	0.20			
1500	8X11.5*	666	0.25	8X16*	732	0.20	8X20*	1104	0.17
	10X12.5	720	0.25	8X20	828	0.18	10X16*	1254	0.15
1800				10X12.5*	876	0.16	10X20	1320	0.15
				10X16	936	0.16			
2200	8X16	690	0.22	8X16*	1020	0.16	10X16*	1404	0.14
	8X20	756	0.22	8X20	1122	0.14	10X20	1476	0.12
2700	10X12.5	708	0.22	10X12.5*	1032	0.14			
				10X16	1140	0.13			
3300	8X20	840	0.18	8X20*	1248	0.13	10X20*	1500	0.13
	10X16	888	0.18	10X16*	1272	0.13	10X25	1578	0.11
3900				10X20	1368	0.12			
	8X20	1056	0.15	10X20	1536	0.106	10X25*	1620	0.096
4700	10X16	1128	0.12				13X20	1728	0.095
	10X20	1176	0.12						
5600	8X25*	1230	0.11	10X25	1650	0.102	10X30*	1776	0.097
	10X20	1308	0.11	13X20	1704	0.098	13X20*	1854	0.094
6800							13X25	1956	0.090
	10X20	1350	0.1	10X25*	1776	0.095	13X20*	2082	0.09
8200	10X25	1362	0.1	10X30	1860	0.093	13X25	2340	0.085
				13X20	1872	0.093			
10000	10X25	1488	0.09	10X30	2076	0.084	13X25*	2436	0.076
	10X30	1560	0.09	13X20*	2028	0.084	13X30	2496	0.072
12000	13X20	1512	0.09	13X25	2124	0.084	16X25	2544	0.072
	10X30	1620	0.085	10X30*	2232	0.070	13X30*	2562	0.068
15000	13X20	1584	0.085	13X25*	2268	0.070	13X35	2628	0.066
				16X25	2316	0.070	16X25*	2700	0.064
18000	13X25	1860	0.08	13X25*	2304	0.065	13X35*	2664	0.05
				13X30	2376	0.065	16X25*	2736	0.06
22000				16X25	2544	0.065	16X31.5	2856	0.058
	13X25	1938	0.075	13X30*	2484	0.065	16X31.5	2886	0.05
27000	13X30	1992	0.07	13X35	2568	0.060	18X25*	2844	0.055
				16X25*	2634	0.057			
33000	13X30	1980	0.068	13X35*	2640	0.054	18X31.5*	3084	0.048
	16X25	2196	0.068	16X31.5	2736	0.050	18X35.5	3168	0.045
39000	13X30*	2520	0.063	16X31.5	2964	0.046	18X35.5*	3252	0.040
	16X25	2718	0.063						

"*" is down size

Ripple Current (mA, rms) at 105°C 100KHz

Max Impedance(Ω) at 20°C 100KHz

φ DxDL(mm)

WV Cap(μ F)	25			35			50		
	Size	Ripple	Impedance	Size	Ripple	Impedance	Size	Ripple	Impedance
0.47							5X11	12	7.23
1							5X11	24	4.31
2.2							5X11	36	3.6
3.3							5X11	48	3.5
4.7							5X11	66	3.3
5.6							5X11	96	3.2
6.8							5X11	96	3.0
8.2							5X11	108	2.8
10	5X11	66	3.01	5X11	84	2.65	5X11	120	2.6
15	5X11	120	2.64	5X11	144	2.29	5X11	150	1.87
22	5X11	144	2.3	5X11	162	1.9	5X11*	162	1.6
							6.3X11	168	1.27
27	5X11	156	2.03	5X11*	174	1.58	6.3X11	192	1.02
				6.3X11	198	1.42			
33	5X11	174	1.72	5X11*	222	1.25	6.3X11*	282	0.87
				6.3X11	240	1.25	6.3X15	296.4	0.85
39	5X11	174	1.5	6.3X11	252	1.1	6.3X11*	306	0.72
							6.3X15	330	0.7
47	5X11	222	1.37	6.3X11	264	0.92	6.3X15	348	0.55
	6.3X11	240	1.28				8X11.5	366	0.55
56	5X11	264	1.25	6.3X11*	282	0.75	8X11.5	378	0.47
				6.3X15	306	0.68			
68	6.3X11	300	0.97	6.3X11*	312	0.62	8X11.5	420	0.36
				6.3X15	348	0.55			
82	6.3X11	312	0.79	6.3X15	354	0.51	6.3X15*	462	0.35
				8X11.5	384	0.47	8X11.5*	492	0.32
100	6.3X11	360	0.68	6.3X15*	378	0.47	8X16	528	0.28
	8X11.5	516	0.54	8X11.5	414	0.45	8X11.5*	540	0.28
120	6.3X11	402	0.58	8X11.5*	546	0.42	8X16	576	0.25
	6.3X15	462	0.56	8X16	612	0.38	8X16	630	0.25
150	6.3X15	510	0.54	8X16	714	0.35	8X16*	696	0.24
	8X11.5	528	0.52	10X12.5	720	0.35	8X20	756	0.24
180							10X16	780	0.24
	6.3X15	546	0.51	8X16	792	0.32	8X20*	864	0.24
220	8X11.5	552	0.46	10X12.5	804	0.32	10X16	912	0.24
	8X16	618	0.42	8X16*	864	0.26	10X16*	1056	0.24
270							10X20	1122	0.2
	8X11.5*	750	0.34	8X20	936	0.24	10X20	1212	0.1
330	8X16	756	0.32	10X12.5*	888	0.24	10X20*	1212	0.1
	10X12.5	816	0.32	8X20*	1056	0.22	10X25	1284	0.1
470	8X16	960	0.25	10X16	1068	0.21			
	10X12.5	924	0.24	8X20*	1140	0.16	10X25*	1404	0.095
560	8X20	1056	0.23	10X16*	1176	0.15	13X20	1500	0.082
	10X12.5*	1020	0.21	10X20*	1302	0.11	13X20*	1776	0.078
680	10X16	1080	0.21	10X25	1398	0.10	13X25	1860	0.078
	8X20*	1224	0.17	13X20	1398	0.10			
820	10X16	1260	0.15	10X25*	1572	0.096	13X20*	2094	0.075
	10X20	1470	0.11	13X20	1584	0.096	13X25	2172	0.070
1000				13X20	1680	0.084	13X25*	2304	0.057
	10X20*	1668	0.11	13X20	1692	0.082	16X25	2376	0.057
1200	10X25	1704	0.1	13X20*	1818	0.068	13X30*	2412	0.052
	10X25*	1812	0.093	13X25	1944	0.062	16X31.5	2484	0.052
1500	13X20	1872	0.090	10X30*	2136	0.060	16X25*	2676	0.050
				13X25*	2184	0.060	16X31.5	2736	0.048
1800	13X20	2028	0.082	13X30	2280	0.058			
	13X20*	2124	0.067	13X25*	2292	0.052	16X31.5*	2952	0.045
2200	13X25	2190	0.065	16X25	2568	0.05	16X35.5	3048	0.042
	13X30	2310	0.058	13X35*	2820	0.048	16X35.5*	3216	0.038
2700	16X25	2340	0.058	16X31.5	2928	0.048			
	13X30*	2592	0.052	16X35*	2976	0.045			
3300	16X25	2712	0.050	16X31.5*	3012	0.045			
	13X35	2850	0.050	18X25*	3228	0.036			
	16X31.5	2958	0.046	18X31.5*	3132	0.036			
	16X31.5*	3204	0.038		3336	0.032			
	16X35.5	3288	0.036						
	18X25*	3156	0.041						

"*" is down size

Ripple Current (mA, rms) at 105°C 100KHz

Max Impedance(Ω)at 20°C 100KHz

FH 105°C high ripple current at frequency range

Features

- ◆ New innovative electrolyte is employed to minimize ESR
- ◆ Long life 4,000 to 10,000 hours at 105°C
- ◆ Non solvent proof type
- ◆ 6.3 to 100VDC newly type
- ◆ RoHS compliant

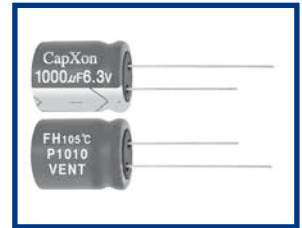

Specifications

Item	Performance Characteristics																											
Operating Temperature Range	-40 to +105°C																											
Rated Voltage Range	6.3 to 100VDC																											
Capacitance Tolerance	±20%(120Hz,+20°C)																											
Capacitance Range	22~5600 µF																											
Leakage Current (+20°C,max.)	I=0.01 CV or 3 (µA) (After 2 minute) with rated working voltage applied.)																											
Dissipation Factor (tan δ , at 20°C , 120Hz)	<table border="1"> <tr> <th>Working Voltage(VDC)</th> <td>6.3</td> <td>10</td> <td>16</td> <td>25</td> <td>35</td> <td>50</td> <td>63</td> <td>100</td> </tr> <tr> <th>D. F.(%) max.</th> <td>22</td> <td>19</td> <td>16</td> <td>14</td> <td>12</td> <td>10</td> <td>9</td> <td>9</td> </tr> </table>	Working Voltage(VDC)	6.3	10	16	25	35	50	63	100	D. F.(%) max.	22	19	16	14	12	10	9	9									
	Working Voltage(VDC)	6.3	10	16	25	35	50	63	100																			
D. F.(%) max.	22	19	16	14	12	10	9	9																				
For capacitance > 1000µF,add 2% per another 1000µF.																												
Low Temperature Characteristics (at 120Hz)	Impedance ratio max																											
	<table border="1"> <tr> <th>Working Voltage(VDC)</th> <td>6.3</td> <td>10</td> <td>16</td> <td>25</td> <td>35</td> <td>50</td> <td>63</td> <td>100</td> </tr> <tr> <th>Z-25°C/Z+20°C</th> <td>4</td> <td>3</td> <td>2</td> <td>2</td> <td>2</td> <td>2</td> <td>2</td> <td>2</td> </tr> <tr> <th>Z-40°C/Z+20°C</th> <td>8</td> <td>6</td> <td>4</td> <td>3</td> <td>3</td> <td>3</td> <td>3</td> <td>3</td> </tr> </table>	Working Voltage(VDC)	6.3	10	16	25	35	50	63	100	Z-25°C/Z+20°C	4	3	2	2	2	2	2	2	Z-40°C/Z+20°C	8	6	4	3	3	3	3	3
	Working Voltage(VDC)	6.3	10	16	25	35	50	63	100																			
Z-25°C/Z+20°C	4	3	2	2	2	2	2	2																				
Z-40°C/Z+20°C	8	6	4	3	3	3	3	3																				
Endurance	Test conditions Duration time :																											
	<table border="1"> <thead> <tr> <th rowspan="2">Voltage</th> <th>SIZE</th> <th>φ D≤6.3</th> <th>φ D = 8,10</th> <th>φ D≥13</th> </tr> </thead> <tbody> <tr> <td>6.3~10WV</td> <td></td> <td>4000 hours</td> <td>6000 hours</td> <td>8000 hours</td> </tr> <tr> <td>16~100WV</td> <td></td> <td>5000 hours</td> <td>7000 hours</td> <td>10000hours</td> </tr> </tbody> </table>	Voltage	SIZE	φ D≤6.3	φ D = 8,10	φ D≥13	6.3~10WV		4000 hours	6000 hours	8000 hours	16~100WV		5000 hours	7000 hours	10000hours												
Voltage	SIZE		φ D≤6.3	φ D = 8,10	φ D≥13																							
	6.3~10WV		4000 hours	6000 hours	8000 hours																							
16~100WV		5000 hours	7000 hours	10000hours																								
Ambient temperature :+105°C Applied voltage :Rated DC working voltage After test requirement at +20°C Capacitance change : within ±25% of the initial measured value Dissipation factor : ≤200% of the initial specified value Leakage current : ≤The initial specified value																												
Shelf Life	Test condition Duration time :1000Hrs Ambient temperature :+105°C Applied voltage :None After test requirement at +20°C:Same limits as Endurance. Pre-treatment for measurements shall be conducted after application of DC working voltage for 30 minutes.																											

Radial

Multiplier for Ripple Current vs. Frequency

CAP(µF)/Hz	50(60)	120	400	1K	10K	100K
CAP ≤ 10	0.47	0.59	0.76	0.85	0.97	1.00
10 < CAP ≤ 100	0.52	0.62	0.80	0.89	0.97	1.00
100 < CAP ≤ 1000	0.58	0.72	0.84	0.90	0.98	1.00
1000 < CAP	0.63	0.78	0.87	0.91	0.98	1.00

Diagram of Dimensions:(unit:mm)

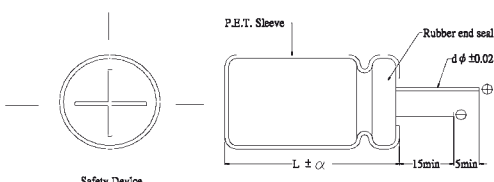

φ D	5	6.3	8	10	13	16	18
F	2.0	2.5	3.5	5.0	5.0	7.5	7.5
φ d	0.5	L < 20		L ≥ 20		0.6	0.8
		0.5	0.6				

α	D < 18	D = 18		D > 18
		L < 35.5	L ≥ 35.5	
	1.5	1.5	2.0	2.0

Case Size

φ DxL(mm)

μ F	WV	6.3				10			
		Size	Ripple	Impedance		Size	Ripple	Impedance	
				20°C	-10°C			20°C	-10°C
100						5×11	215	0.580	2.300
150		5×11	190	0.550	2.300				
220		6.3×11	290	0.260	0.900	6.3×11	340	0.230	0.870
330		6.3×11	330	0.210	0.870	6.3×11	380	0.220	0.870
470		8×11.5	425	0.140	0.580	8×11.5	600	0.130	0.520
680		8×11.5	520	0.130	0.520	8×16	770	0.096	0.350
						10×12.5	800	0.085	0.310
820		10×12.5	800	0.090	0.320	10×16	920	0.075	0.280
1000		8×16	850	0.080	0.350	8×20	1050	0.072	0.270
						10×16	1110	0.064	0.240
1200		8×20	1000	0.075	0.260	10×20	1380	0.045	0.180
		10×16	1020	0.064	0.240				
1500		10×20	1340	0.050	0.180	10×25	1550	0.043	0.170
2200		10×25	1550	0.046	0.170	10×30	1880	0.030	0.120
						13×20	1800	0.035	0.120
3300		13×20	1720	0.038	0.120	13×25	2120	0.029	0.089
3900		13×25	1840	0.029	0.088	13×30	2400	0.025	0.078
4700		13×30	2400	0.027	0.078				
5600		13×35	2650	0.024	0.065				

Ripple Current (mA, rms) at 105°C 100KHz

Max Impedance (Ω) at 20°C 100KHz

φ DxL(mm)

μ F	WV	16V				25V			
		Size	Ripple	Impedance		Size	Ripple	Impedance	
				20°C	-10°C			20°C	-10°C
47						5×11	160	0.560	2.300
56		5×11	200	0.560	2.300	5×11	240	0.560	2.300
100		6.3×11	280	0.220	0.820	6.3×11	350	0.250	0.870
120		6.3×11	310	0.215	0.870				
220		8×11.5	480	0.180	0.850	8×11.5	590	0.150	0.520
330		8×11.5	600	0.140	0.520	8×16	810	0.092	0.350
						10×12.5	826	0.082	0.320
470		8×16	780	0.095	0.350	8×20	1020	0.074	0.270
		10×12.5	800	0.085	0.320	10×16	1210	0.068	0.240
680		8×20	1000	0.080	0.270	10×20	1400	0.050	0.180
820		10×20	1280	0.052	0.220	10×25	1580	0.041	0.170
1000		10×20	1380	0.046	0.180	10×30	1820	0.032	0.120
		13×16	1420	0.050	0.160	13×20	1800	0.036	0.120
1200		10×25	1560	0.044	0.170				
1500		13×20	1720	0.037	0.120	13×25	2240	0.028	0.089
1800		13×25	2030	0.030	0.095	13×30	2640	0.024	0.078
2200		13×25	2200	0.026	0.089	13×35	2880	0.023	0.065
2700		13×30	2600	0.023	0.077	16×25	2820	0.022	0.060
3300		13×35	2860	0.022	0.066				
4700		18×25	3000	0.020	0.049				

Ripple Current (mA, rms) at 105°C 100KHz

Max Impedance (Ω) at 20°C 100KHz

www.amelec.ch
info@amelec.ch

φ D×L(mm)

μ F	WV	35V				50V			
		Size	Ripple	Impedance		Size	Ripple	Impedance	
				20°C	-10°C			20°C	-10°C
22						5×11	220	0.650	2.800
33		5×11	230	0.550	2.300				
47		5×11	280	0.45	1.8	6.3×11	260	0.370	1.500
56		6.3×11	360	0.210	0.860	6.3×11	300	0.290	1.200
100		6.3×11	450	0.18	0.72	8×11.5	680	0.160	0.670
120						8×16	760	0.120	0.480
150		8×11.5	680	0.140	0.520	10×12.5	800	0.120	0.480
180						8×20	1000	0.090	0.360
220		8×16	1000	0.090	0.350	10×16	1300	0.082	0.340
		10×12.5	1060	0.080	0.320				
270		8×20	1180	0.070	0.260	10×20	1350	0.060	0.240
330		10×16	1380	0.062	0.240	10×25	1600	0.057	0.220
470		10×20	1800	0.048	0.180	10×30	1800	0.048	0.170
560		10×25	1900	0.042	0.160	13×25	1950	0.042	0.110
680		10×30	2000	0.035	0.120				
		13×20	2100	0.034	0.120				
1000		13×25	2400	0.028	0.088				
1200		13×30	2800	0.024	0.078	16×31.5	2870	0.030	0.066
		16×21	2800	0.028	0.078				
1500		13×35	3000	0.022	0.065				
1800		16×25	2850	0.020	0.060				
2700		16×35.5	3500	0.018	0.044				
		18×31.5	3850	0.016	0.040				

Ripple Current (mA, rms) at 105°C 100KHz
 Max Impedance (Ω) at 20°C 100KHz

φ D×L(mm)

μ F	WV	63V				100V			
		Size	Ripple	Impedance		Size	Ripple	Impedance	
				20°C	-10°C			20°C	-10°C
27						8×11.5	300	0.610	2.80
33		6.3×11	260	1.200	5.00				
47		8×11.5	360	0.660	3.10	10×12.5	400	0.420	1.80
56		8×11.5	380	0.600	2.80				
68						10×16	460	0.300	1.50
82		8×16	460	0.440	2.10	10×20	600	0.210	0.94
		10×12.5	500	0.430	1.80				
100		10×12.5	640	0.340	1.80	10×25	800	0.200	0.84
120		8×20	700	0.320	1.60				
		10×16	760	0.300	1.50	13×20	900	0.160	0.64
180		10×20	880	0.190	0.94				
220		10×25	1100	0.185	0.84				
270		13×20	1200	0.160	0.64	16×25	1480	0.073	0.27
330		13×25	1600	0.120	0.45	13×40	1600	0.071	0.30
390						16×31.5	1700	0.055	0.20
						18×25	1740	0.054	0.21
470		13×30	1800	0.100	0.42	16×35.5	1880	0.047	0.17
	18×31.5					1600	0.047	0.17	
560		16×25	2000	0.073	0.27				
680		13×40	2200	0.070	0.30	18×35.5	1720	0.042	0.15
820		16×31.5	2400	0.054	0.20	18×41	2340	0.040	0.13
1000		16×35.5	2500	0.048	0.17				
		18×31.5	2800	0.047	0.17				
1200		16×41	2920	0.040	0.15				
		18×35.5	3000	0.039	0.15				
1500		18×41	3200	0.036	0.13				

Ripple Current (mA, rms) at 105°C 100KHz

Max Impedance (Ω) at 20°C 100KHz

KL Series Long Life 5,000 hrs

Features

- ◆ Used in electronic ballast, switching power supply, industrial measuring instruments.
- ◆ Endurance 5000 Hrs at 105°C
- ◆ Safety vent construction design.
- ◆ RoHS Compliant

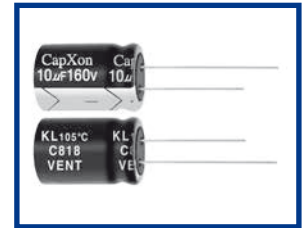

Specifications

Item	Performance Characteristics														
Operating Temperature Range	-25 to +105°C														
Rated Voltage Range	160 to 450 VDC														
Capacitance Range	10 to 220 µF														
Capacitance Tolerance	±20%(120Hz,+20°C)														
Leakage Current (+20°C,max.)	$I \leq 0.04 CV + 100 (\mu A)$ After 1 minute with rated working voltage applied.														
Dissipation Factor (tan δ , at 20°C , 120Hz)	<table border="1"> <tr> <th>Working Voltage(VDC)</th> <td>160</td> <td>200</td> <td>250</td> <td>350</td> <td>400</td> <td>450</td> </tr> <tr> <th>D. F.(%) max.</th> <td>12</td> <td>12</td> <td>12</td> <td>15</td> <td>15</td> <td>17</td> </tr> </table>	Working Voltage(VDC)	160	200	250	350	400	450	D. F.(%) max.	12	12	12	15	15	17
	Working Voltage(VDC)	160	200	250	350	400	450								
D. F.(%) max.	12	12	12	15	15	17									
Low Temperature Characteristics (at 120Hz)	Impedance ratio max <table border="1"> <tr> <th>Working Voltage(VDC)</th> <td>160</td> <td>200</td> <td>250</td> <td>350</td> <td>400</td> <td>450</td> </tr> <tr> <th>Z-25°C / Z+20°C</th> <td>3</td> <td>3</td> <td>3</td> <td>6</td> <td>6</td> <td>6</td> </tr> </table>	Working Voltage(VDC)	160	200	250	350	400	450	Z-25°C / Z+20°C	3	3	3	6	6	6
Working Voltage(VDC)	160	200	250	350	400	450									
Z-25°C / Z+20°C	3	3	3	6	6	6									
Endurance	Test conditions Duration time : 5000Hrs Ambient temperature : +105°C Applied voltage : Rated DC working voltage After test requirement at +20°C Capacitance change : ≤ ±20% of the initial measured value Dissipation factor : ± 200% of the initial specified value Leakage current : ± The initial specified value														
Shelf Life	Test conditions Duration time : 1000Hrs Ambient temperature : +105°C Applied voltage : None After test requirement at +20°C: Same limits as Endurance. Pre-treatment for measurements shall be conducted after application of DC working voltage for 30 minutes.														

Radial

Multiplier for Ripple Current vs. Frequency

Frequency(Hz)	120	1K	10K	100KHz
Multiplier	1.0	1.5	1.70	1.90

Diagram of Dimensions:(unit:mm)

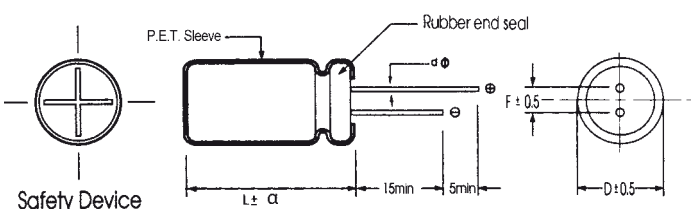

D φ	10	13	16	18	22
F	5.0	5.0	7.5	7.5	10
d φ	0.6		0.8		

α	D < 18	D = 18		D > 18
		L < 35.5	L ≥ 35.5	
	1.5	1.5	2.0	2.0

Case Size

WV Cap(μF)		160		200		250		350		400		450	
		Size	Ripple	Size	Ripple	Size	Ripple	Size	Ripple	Size	Ripple	Size	Ripple
10		10x16	115	10x20	210	10x20	200	13x20	180	13x20	200	13x25	130
22		10x20	195	10x20	255	13x20	350	13x20	250	13x25	320	16x25	170
33		13x20	250	13x20	350	13x25	400	16x21	320	16x25	350	16x31.5	215
47		13x20	300	13x20	490	13x25	500	16x31.5	440	16x31.5	450		
68		13x25	390	13x25	530	16x25	600	16x35.5	450				
100		16x25	560	16x25	810	18x31.5	660						
220		16x31.5	730	18x31.5	970	22x41	750						

φ DxL(mm)

Ripple Current (mA, rms) at 105°C 120Hz

KH Series Long Life 5,000~10,000 hrs

Features

- ◆ Used in electronic ballast, switching power supply, industrial measuring instruments.
- ◆ higher ripple current
- ◆ Endurance 5000~10000 Hrs at 105°C
- ◆ Safety vent construction design.
- ◆ RoHS Compliant

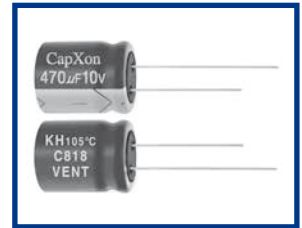

Specifications

Item	Performance Characteristics								
Operating Temperature Range	-40 to +105°C	-25 to +105°C							
Rated Voltage Range	10 to 50 VDC	160 to 450 VDC							
Capacitance Range	6.8 to 3300 µF	6.8 to 220 µF							
Capacitance Tolerance	±20%(120Hz,+20°C)								
Leakage Current (+20°C,max.)	$I \leq 0.01 CV$ or $3 (\mu A)$	$I \leq 0.04 CV+100 (\mu A)$							
	After 1 minute with rated working voltage applied. I =Leakage Current(µA) C =Rated capacitance(µF) V =Rated Voltage(V)								
Dissipation Factor (tan δ , at 20°C , 120Hz)	Working oltage(VDC)	10 16 25 35 50 160 200 250 350 400 450							
	D.F.(%)max.	19 16 14 12 10 15 15 15 20 20 20							
Low Temperature Characteristics (at 120Hz)	Impedance ratio max								
	Working oltage(VDC)	10 16 25 35 50 160 200 250 350 400 450							
Endurance	Test conditions								
	Duration time : as right Ambient temperature : +105°C Applied voltage : Rated DC working voltage	<table border="1"> <thead> <tr> <th>D φ</th> <th>Life hours</th> </tr> </thead> <tbody> <tr> <td>< 8 φ</td> <td>5,000</td> </tr> <tr> <td>8 φ</td> <td>8,000</td> </tr> <tr> <td>≥ 10 φ</td> <td>10,000</td> </tr> </tbody> </table>	D φ	Life hours	< 8 φ	5,000	8 φ	8,000	≥ 10 φ
D φ	Life hours								
< 8 φ	5,000								
8 φ	8,000								
≥ 10 φ	10,000								
Shelf Life	Test conditions								
	Duration time : 1000Hrs Ambient temperature : +105°C Applied voltage : None	After test requirement at +20°C: Same limits as Endurance. Pre-treatment for measurements shall be conducted after application of DC working voltage for 30 minutes.							

Radial

Multiplier for Ripple Current vs. Frequency

Frequency(Hz)	120	1K	10K	≥100K
Multiplier	0.50	0.80	0.85	1.0

Diagram of Dimensions:(unit:mm)

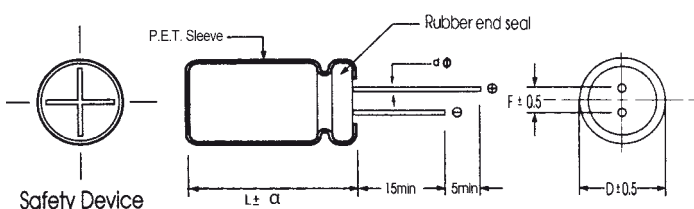

Dφ	5	6.3	8	10	13	16	18
F	2.0	2.5	3.5	5.0	5.0	7.5	7.5
dφ	0.5			0.6		0.8	

α	D < 18	D = 18		D > 18
		L < 35.5	L ≥ 35.5	
	1.5	1.5	2.0	2.0

Case Size

φ DxL(mm)

WV Cap(μF)	10		16		25		35		50	
	Size	Ripple	Size	Ripple	Size	Ripple	Size	Ripple	Size	Ripple
6.8									5x11	75
10							5x11	65	5x11	97
22					5x11	100	5x11	125	6.3x11	130
33			5x11	115	5x11	130	6.3x11	178	8x11.5	241
47	5x11	100	5x11	145	6.3x11	160	8x11.5	240	8x11.5	287
										300
68	5x11	130	6.3x11	200	8x11.5	230	8x11.5	270	10x12.5	356
100	6.3x11	190	8x11.5	245	8x11.5	327	10x12.5	390	10x16	500
150	6.3x11	220	8x11.5	300	10x12.5	460	10x16	632	10x20	747
220	6.3x11	270	8x11.5	420	10x16	580	10x20	760	13x20	977
			10x12.5	495						
330	8x11.5	390	8x16	500	10x20	805	13x20	1035	13x25	1150
470	10x12.5	540	10x16	730	10x20	950	13x25	1100	16x25	1552
1000	10x16	900	13x20	1173	13x25	1552	16x31.5	1932	18x31.5	2093
2200	13x20	1540	16x25	2093	16x31.5	2400				
3300	16x25	1900								

WV Cap(μF)	160		200		250		350		400		450	
	Size	Ripple	Size	Ripple	Size	Ripple	Size	Ripple	Size	Ripple	Size	Ripple
6.8							10x20	270	10x12.5	220	13x20	240
									10x16	245		
									10x20	270		
10	10x16	280	10x20	310	10x20	320	13x20	350	10x16	274	13x20	390
									10x20	300	13x25	430
									13x20	350		
22	10x20	450	10x20	470	13x20	490	13x25	600	13x20	557	13x25	632
									16x21	640	16x21	659
									16x25	690	16x25	710
33	13x20	610	13x20	620	13x25	750	16x21	820	18x21	870	18x21	883
											18x25	950
47	13x20	680	13x20	910	16x21	930	18x21	1020	18x21	1050	18x31.5	1120
									18x25	1130		
68	13x25	1100	16x25	1190	18x21	1300	18x25	1400	18x31.5	1460		
100	18x21	1310	18x21	1380	18x25	1500						
150	18x25	1780	18x25	1800	18x31.5	1870						
220	18x25	2290	18x31.5	2350								

Ripple Current (mA, rms) at 105°C 100KHz

TH Series High Temperature

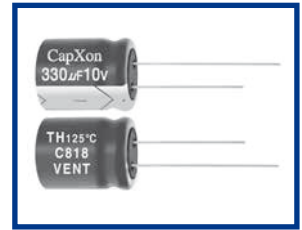

Features

- ◆ The series has guaranteed operating life of 1000~2000 hours at 125°C widest operating temperature range, -40 to +125°C
- ◆ Applications : High reliability equipment, filtering circuit of switching power supply, and industrial control equipment.
- ◆ RoHS Compliant

Specifications

Item	Performance Characteristics											
Operating Temperature Range	-40 to +125°C	-25 to +125°C										
Rated Voltage Range	10 to 100 VDC	160 to 350 VDC										
Capacitance Range	0.47 to 1000 µF	1 to 100 µF										
Capacitance Tolerance	±20%(120Hz,+20°C)											
Leakage Current (+20°C,max.)	I ≤ 0.01 CV or 3(µA) After 1 minute whichever is greater measured with rated working voltage applied.	I ≤ 0.02 CV (µA) After 1 minute withrated working voltage applied.										
Dissipation Factor (tan δ , at 20°C , 120Hz)	Working Voltage(VDC)	10 16 25 35 50 63 100										
	D. F.(%) max.	18 15 13 12 10 8 7										
	Working Voltage(VDC)	160 200 250 350										
	D. F.(%) max.	7 8 10 12										
	For capacitance > 1000 uF, add 2% per another 1000uF.											
Low Temperature Characteristics (at 120Hz)	Impedance ratio max											
	Working Voltage(VDC)	10	16	25	35	50	63	100	160-250	350-450		
	Z-25°C / Z+20°C	3	2	2	2	2	2	2	3	6		
	Z-40°C / Z+20°C	4	4	4	4	4	4	4	-	-		
Endurance	Test conditions Duration time : 1000~2000Hrs Ambient temperature : +125°C Applied voltage : Rated DC working voltage After test requirement at +20°C								D φ		Life hours	
	Capacitance change : ≤ ±20% of the initial measured value Dissipation factor : ≤ 300% of the initial specified value Leakage current : ≤ The initial specified value								≤ 8 φ		1,000	
Shelf Life	Test conditions Duration time : 1000Hrs Ambient temperature : +125°C Applied voltage : None After test requirement at +20°C: Same limits as Endurance. Pre-treatment for measurements shall be conducted after application of DC working voltage for 30 minutes.								≥ 10 φ		2,000	

Radial

Multiplier for Ripple Current vs. Frequency

CAP(µF)\Frequency(Hz)	50(60)	120	400	1K	10K	50K-100K
CAP ≤ 10	0.8	1	1.30	1.45	1.65	1.70
10 < CAP ≤ 100	0.8	1	1.23	1.36	1.48	1.53
100 < CAP ≤ 1000	0.8	1	1.16	1.25	1.35	1.38
1000 < CAP	0.8	1	1.11	1.17	1.25	1.28

Diagram of Dimensions:(unit:mm)

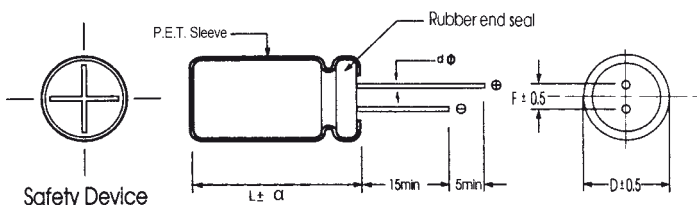

D φ	5	6.3	8	10	13	16	18
F	2.0	2.5	3.5	5.0	5.0	7.5	7.5
d φ	0.5			0.6		0.8	

α	D < 18	D = 18		D > 18
		L < 35.5	L ≥ 35.5	
	1.5	1.5	2.0	2.0

Case Size

φ DxL(mm)

WV Cap(μF)	10		16		25		35		50		63	
	Size	Ripple	Size	Ripple	Size	Ripple	Size	Ripple	Size	Ripple	Size	Ripple
4.7											6.3X11	38
10									6.3X11	48	8X11.5	55
22					6.3X11	70	6.3X11	82	6.3X11	75	8X11.5	93
33			6.3X11	91	6.3X11	100	8X11.5	108	8X11.5	122	8X11.5	110
47	5X11	92	6.3X11	110	6.3X11	110	8X11.5	130	8X11.5	140	10X12.5	150
					8X11.5	130	10X12.5	158	10X12.5	164	10X16	172
100	6.3X11	145	6.3X11	175	8X11.5	210	10X12.5	230	10X16	250	10X16	260
			8X11.5	206	10X12.5	250	10X16	262	10X20	277	10X20	295
220	8X11.5	330	8X11.5	340	10X12.5	420	10X16	480	10X25	560	13X20	540
			10X12.5	400	10X16	470	10X20	540	13X20	587	13X25	595
330	8X11.5	340	10X12.5	470	10X16	570	10X25	680	13X20	810	13X25	880
	10X12.5	410	10X16	525	10X20	631	13X20	718	13X25	900	16X25	1000
470	10X12.5	505	10X16	650	10X25	770	13X20	810	13X25	900		
	10X16	525	10X20	720	13X20	810	13X25	900	16X25	1000		
1000	10X16	870	10X25	950	13X25	970	16X25	1080				
	10X20	960	13X20	1000	16X25	1100	16X31.5	1200				

WV Cap(μF)	100		160		200		250		350	
	Size	Ripple	Size	Ripple	Size	Ripple	Size	Ripple	Size	Ripple
0.47	6.3X11	14								
1	6.3X11	24	6.3X11	30	6.3X11	36	6.3X11	41	8X11.5	45
2.2	6.3X11	31	6.3X11	37	6.3X11	43	6.3X11	42	8X11.5	47
							8X11.5	50	10X12.5	55
3.3	6.3X11	36	6.3X11	37	8X11.5	48	8X11.5	50	10X12.5	55
			8X11.5	41			10X12.5	53	10X16	60
4.7	6.3X11	38	8X11.5	52	8X11.5	50	10X12.5	60	10X16	68
	8X11.5	45			10X12.5	60	10X16	68	10X20	75
10	8X11.5	60	8X11.5	70	10X12.5	80	10X16	83	10X25	105
	10X12.5	70	10X12.5	82	10X16	88	10X20	92	13X20	110
22	10X12.5	90	10X16	115	10X25	125	13X20	145	13X25	160
	10X16	100	10X20	128	13X20	135	13.25	160	16X25	180
33	10X16	140	10X25	155	13X20	155	13X25	164	16X25	180
	10X20	158	13X20	164	13X25	172	16X25	185	16X31.5	200
47	10X25	175	13X20	180	13X25	190	16X25	205	16X31.5	230
	13X20	185	13X25	200	16X25	215	16X31.5	230	16X35.5	245
100	13X25	270	13X25	320	16X25	360				
	16X25	310	16X25	365	16X31.5	400				

Ripple Current (mA, rms) at 125°C 120Hz

TE Series High Temperature

Features

- ◆ The series has guaranteed operation life of 2000~3000 hours at 130°C wide operating temperature range, -40 to +130°C
- ◆ Applications :High reliability equipment, filtering circuit of switching power supply, and industrial control equipment.
- ◆ RoHS Compliant

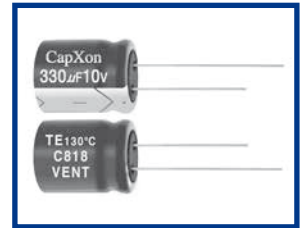

Specifications

Item	Performance Characteristics																		
Operating Temperature Range	-40 to +130°C																		
Rated Voltage Range	10 to 50 VDC																		
Capacitance Range	3.3to 4700 µF																		
Capacitance Tolerance	±20%(120Hz,+20°C)																		
Leakage Current (+20°C,max.)	I ≤ 0.01 CV or 3 (µA) After 1 minute whichever is greater measured with rated working voltage applied.																		
Dissipation Factor (tan δ , at 20°C , 120Hz)	<table border="1"> <tr> <td>Working Voltage(VDC)</td> <td>10</td> <td>16</td> <td>25</td> <td>35</td> <td>50</td> </tr> <tr> <td>D. F.(%) max.</td> <td>20</td> <td>16</td> <td>14</td> <td>12</td> <td>10</td> </tr> </table> <p>For capacitance > 1000uF, add 2% per another 1000uF.</p>	Working Voltage(VDC)	10	16	25	35	50	D. F.(%) max.	20	16	14	12	10						
Working Voltage(VDC)	10	16	25	35	50														
D. F.(%) max.	20	16	14	12	10														
Low Temperature Characteristics (at 120Hz)	<p>Impedance ratio max</p> <table border="1"> <tr> <td>Working Voltage(VDC)</td> <td>10</td> <td>16</td> <td>25</td> <td>35</td> <td>50</td> </tr> <tr> <td>Z-25°C / Z+20°C</td> <td>3</td> <td>2</td> <td>2</td> <td>2</td> <td>2</td> </tr> <tr> <td>Z-40°C / Z+20°C</td> <td>4</td> <td>4</td> <td>4</td> <td>4</td> <td>4</td> </tr> </table>	Working Voltage(VDC)	10	16	25	35	50	Z-25°C / Z+20°C	3	2	2	2	2	Z-40°C / Z+20°C	4	4	4	4	4
Working Voltage(VDC)	10	16	25	35	50														
Z-25°C / Z+20°C	3	2	2	2	2														
Z-40°C / Z+20°C	4	4	4	4	4														
Endurance	<p>Test conditions</p> <p>Duration time : as right</p> <p>Ambient temperature : +130°C</p> <p>Applied voltage : Rated DC working voltage</p> <table border="1"> <tr> <th>D φ</th> <th>Life hours</th> </tr> <tr> <td>≤ 8 φ</td> <td>2,000</td> </tr> <tr> <td>≥ 10 φ</td> <td>3,000</td> </tr> </table> <p>After test requirement at +20°C</p> <p>Capacitance change : ≤ ±30% of the initial measured value</p> <p>Dissipation factor : ≤ 300% of the initial specified value</p> <p>Leakage current : ≤ The initial specified value</p>	D φ	Life hours	≤ 8 φ	2,000	≥ 10 φ	3,000												
D φ	Life hours																		
≤ 8 φ	2,000																		
≥ 10 φ	3,000																		
Shelf Life	<p>Test conditions</p> <p>Duration time : 1000Hrs</p> <p>Ambient temperature : +130°C</p> <p>Applied voltage : None</p> <p>After test requirement at +20°C: Same limits as Endurance.</p> <p>Pre-treatment for measurements shall be conducted after application of DC working voltage for 30 minutes.</p>																		

Radial

Multiplier for Ripple Current vs. Frequency

CAP(µ F) \ Frequency(Hz)	50(60)	120	400	1K	10K	50K-100K
CAP ≤ 10	0.8	1	1.30	1.45	1.65	1.70
10 < CAP ≤ 100	0.8	1	1.23	1.36	1.48	1.53
100 < CAP ≤ 1000	0.8	1	1.16	1.25	1.35	1.38
1000 < CAP	0.8	1	1.11	1.17	1.25	1.28

Diagram of Dimensions:(unit:mm)

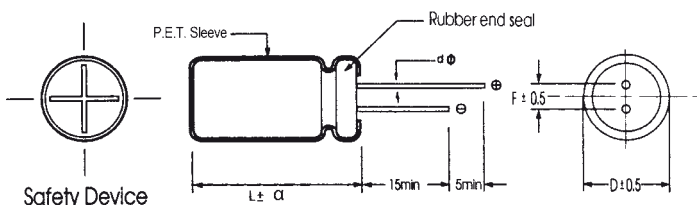

D φ	6.3	8	10	13	16	18
F	2.5	3.5	5.0	5.0	7.5	7.5
d φ	0.5		0.6		0.8	

α	D < 18	D = 18		D > 18
		L < 35.5	L ≥ 35.5	
	1.5	1.5	2.0	2.0

Case Size

φ DxL(mm)

WV Cap(μF)	10		16		25		35		50	
	Size	Ripple	Size	Ripple	Size	Ripple	Size	Ripple	Size	Ripple
3.3										
4.7										
10									6.3x11	150
22									6.3x11	220
33									8x11.5	270
47									10x12.5	300
100							10x16	420	10x16	480
220	8x11.5	250	10x12.5	260	10x16	330	10x20	520	13x20	700
330	8x11.5	330	10x16	360	10x20	540	13x20	700	13x25	820
	10x12.5	350								
470	10x12.5	500	10x20	600	13x20	720	13x25	880	16x25	1000
	10x16	540								
1000	10x20	880	13x20	930	16x25	950	16x31.5	1150	16x31.5	1850
1500	13x20	1120	13x25	1250	16x31.5	1550	16x35.5	1850		
2200	13x25	1350	16x25	1400	16x35.5	2010	18x35.5	2300		
3300	16x25	1820	16x31.5	2150	18x35.5	2300				
4700	16x31.5	2210	16x35.5	2350						

Ripple Current (mA, rms) at 130°C 120Hz

KS Series 105°C Overvoltage Vent Operation Facility

Features

- ◆ High ripple current capability.
- ◆ This series has specification of vent operation in overvoltage situation.
- ◆ RoHS Compliant

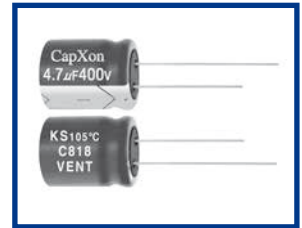

Specifications

Item	Performance Characteristics		
Operating Temperature Range	-25~+105°C		
Rated Voltage Range	200V、400V		
Capacitance Tolerance	±20%(120Hz,+20°C)		
Leakage Current (+20°C,max.)	I ≤ 0.03 CV (µA) After 1 minute with rated working voltage applied.		
Dissipation Factor (tan δ · at 20°C · 120Hz)	Working Voltage(VDC)	200	400
	D.F.(%)max.	15	15
Endurance	Test condition		
	Duration time	:2000 Hrs	
	Ambient temperature	:+105°C	
	Applied voltage	:Rated DC working voltage	
	After test requirement at +20°C		
	Capacitance change	: ≤ ±20% of the initial measured value	
Shelf Life	Test condition		
	Duration time	:1000 Hrs	
	Ambient temperature	:+105°C	
	Applied voltage	:None	
After test requirement at +20°C:Same limits as Endurance.			
Pre-treatment for measurements shall be conducted after application of DC working voltage for 30 minutes.			

Multiplier for Ripple Current vs. Frequency

VDC	Capacitance(µF)	Frequency(Hz)				
		60(50)	120	400	1K	≥10K
200	22~470	0.85	1.00	1.10	1.25	1.50
400	4.7~68	0.85	1.00	1.05	1.20	1.40
	82~150	0.85	1.00	1.03	1.15	1.35

Diagram of Dimensions:(unit:mm)

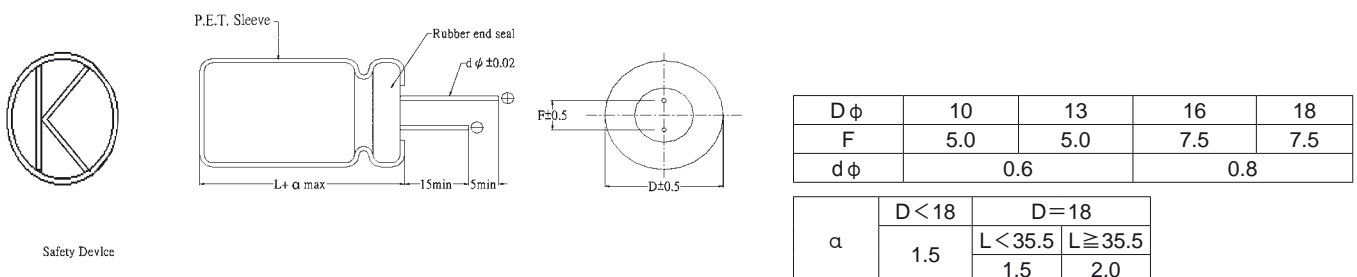

Case Size

φ DxL(mm)

WV Cap(μ F)	200		WV Cap(μ F)	400	
	Size	Ripple		Size	Ripple
22	10X20	120	4.7	10X12.5	60
33	10X25	160	10	10X16	100
	13X20	160		10X20	125
47	10X30	195	22	13X20	135
	13X20	195		13X25	150
56	13X25	210		16X21	150
68	13X25	270	33	13X25	180
	16X21	270		16X21	210
82	13X30	310	47	16X31.5	300
	16X21	320		16X35.5	320
	16X25	360		18X25	300
100	16X25	400		18X31.5	320
120	18X21	400	56	16X31.5	360
	16X25	460		18X25	350
	16X31.5	500		18X31.5	370
150	18X25	500	68	16X31.5	365
	16X31.5	560		16X35.5	380
	16X35.5	590		18X31.5	375
180	18X25	560	82	16X35.5	410
	16X35.5	600		18X31.5	410
220	18X31.5	650		18X35.5	450
	18X35.5	700	100	16X35.5	470
330	740	18X31.5		470	
390	18X35.5	780		18X35.5	490
	18X41	840	120	18X31.5	520
470	18X41	860		18X35.5	540
	18X45	920		18X41	560
	18X45	1120	150	18X35.5	770
				18X41	790

Ripple Current (mA, rms) at 105°C 120Hz

FK Series Long Life for ballast 105°C

Features

- ◆ Specially designed for electronic ballast and energy-save lamp
- ◆ Endurance 6000~8000 hrs at 105°C
- ◆ Safety vent construction design.
- ◆ RoHS Compliant

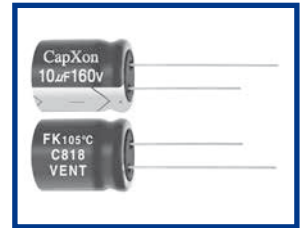

Specifications

Item	Performance Characteristics												
Operating Temperature Range	-25~+105°C												
Rated Voltage Range	160~450 VDC												
Capacitance Range	1 to 330 µF												
Capacitance Tolerance	±20%(120Hz,+20°C)												
Leakage Current (+20°C,max.)	I ≤ 0.04 CV + 100 (µA) After 1 minute with rated working voltage applied.												
Dissipation Factor (tan δ , at 20°C , 120Hz)	Working Voltage(VDC)	160	200	250	350	400	450						
	D.F.(%)max.	10	10	10	12	12	12						
Low Temperature Characteristics (at 120Hz)	Impedance ratio max												
	Working voltage(VDC)	160	200	250	350	400	450						
Z-25°C / Z+20°C	3	3	3	6	6	6							
Endurance	Test condition Duration time :As right Ambient temperature :+105°C Applied voltage :Rated DC working voltage After test requirement at +20°C Capacitance change : with ±20% of the initial measured value Dissipation factor : ≤200% of the initial specified value Leakage current : ≤The initial specified value						<table border="1"> <tr> <th>D φ</th> <th>Life (hours)</th> </tr> <tr> <td>8 φ</td> <td>6000</td> </tr> <tr> <td>≥ 10 φ</td> <td>8000</td> </tr> </table>	D φ	Life (hours)	8 φ	6000	≥ 10 φ	8000
	D φ	Life (hours)											
8 φ	6000												
≥ 10 φ	8000												
Shelf Life	Test condition Duration time :1000Hrs Ambient temperature :+105°C Applied voltage :None After test requirement at +20°C:Same limits as Endurance. Pre-treatment for measurements shall be conducted after application of DC working voltage for 30 minutes.												

Radial

Multiplier for Ripple Current vs. Frequency

Frequency (Hz)	120	1K	10K	≥10K
Multiplier	1.0	1.5	1.70	1.90

Diagram of Dimensions:(unit:mm)

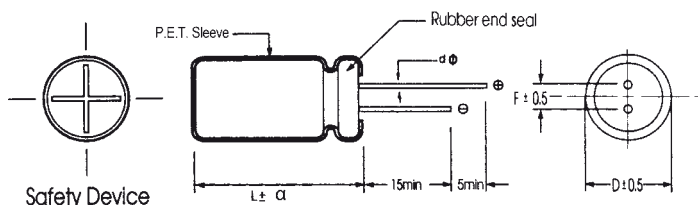

D φ	8	10	13	16	18
F	3.5	5.0	5.0	7.5	7.5
d φ	L < 20	L ≥ 20			
	0.5	0.6		0.6	0.8
α	D < 18		D = 18		D > 18
	1.5		L < 35.5	L ≥ 35.5	
			1.5	2.0	2.0

Case Size

φ DxL(mm)

WV Cap(μF)	160		200		250		350		400		450	
	Size	Ripple	Size	Ripple	Size	Ripple	Size	Ripple	Size	Ripple	Size	Ripple
1.0							8X11.5	75	8X11.5	65	8X11.5	85
2.2					8X11.5	70	8X11.5	80	8X11.5	85	10X12.5	90
3.3					8X11.5	75	10X12.5	85	10X12.5	95	10X16	105
4.7			8X11.5	80	10X12.5	100	10X12.5	100	10X16	110	10X16	115
6.8			8X11.5	100	10X12.5	105	10X16	110	10X16	115	10X20	125
10	10X12.5	105	10X12.5	115	10X16	130	10X20	140	10X20	160	13X20	175
22	10X16	170	10X16	170	10X20	190	13X20	245	13X20	230	16X21	275
33	10X20	235	10X20	245	13X20	305	13X25	340	13X25	310	16X25	370
47	13X20	285	13X20	370	13X25	370	16X25	410	16X31.5	445	18X25	455
68	13X20	445	13X 25	425	16X25	495	18X25	530	18X31.5	550	18X31.5	600
100	16X21	550	16X25	600	16X31.5	645	18X35.5	665	18X41	750		
150	16X25	655	16X31.5	825	18X31.5	775						
220	18X31.5	875	18X31.5	1000								
330	18X35.5	1190										

Ripple Current (mA, rms) at 105°C 120Hz

FL Series Long Life for ballast 105°C

Features

- ◆ Specially designed for electronic ballast and energy-save lamp
- ◆ Endurance 8000~10000 hrs at 105°C
- ◆ Safety vent construction design.
- ◆ RoHS Compliant

FK long life **FL**

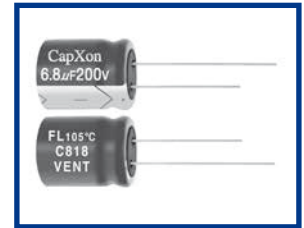

Specifications

Item	Performance Characteristics														
Operating Temperature Range	-25~+105°C														
Rated Voltage Range	160~450 VDC														
Capacitance Range	0.1 to 330 µ F														
Capacitance Tolerance	±20%(120Hz,+20°C)														
Leakage Current (+20°C,max.)	I=0.04 CV +100 (µ A) (After 1 minute with rated working voltage applied.)														
Dissipation Factor (tan δ , at 20°C , 120Hz)	<table border="1"> <tr> <td>Working Voltage(VDC)</td> <td>160</td> <td>200</td> <td>250</td> <td>350</td> <td>400</td> <td>450</td> </tr> <tr> <td>D.F.(%)max.</td> <td>10</td> <td>10</td> <td>10</td> <td>12</td> <td>12</td> <td>12</td> </tr> </table>	Working Voltage(VDC)	160	200	250	350	400	450	D.F.(%)max.	10	10	10	12	12	12
	Working Voltage(VDC)	160	200	250	350	400	450								
D.F.(%)max.	10	10	10	12	12	12									
(+20°C , at 120Hz)															
Low Temperature Characteristics (at 120Hz)	Impedance ratio max														
	<table border="1"> <tr> <td>Working voltage(VDC)</td> <td>160</td> <td>200</td> <td>250</td> <td>350</td> <td>400</td> <td>450</td> </tr> <tr> <td>Z-25°C / Z+20°C</td> <td>3</td> <td>3</td> <td>3</td> <td>6</td> <td>6</td> <td>6</td> </tr> </table>	Working voltage(VDC)	160	200	250	350	400	450	Z-25°C / Z+20°C	3	3	3	6	6	6
Working voltage(VDC)	160	200	250	350	400	450									
Z-25°C / Z+20°C	3	3	3	6	6	6									
Endurance	Test condition Duration time :As right Ambient temperature :+105°C Applied voltage :Rated DC working voltage														
	<table border="1"> <tr> <td>φ D</td> <td>Life (hours)</td> </tr> <tr> <td>8 φ</td> <td>8000</td> </tr> <tr> <td>≥ 10 φ</td> <td>10000</td> </tr> </table>	φ D	Life (hours)	8 φ	8000	≥ 10 φ	10000								
φ D	Life (hours)														
8 φ	8000														
≥ 10 φ	10000														
Shelf Life	Test condition Duration time :1000 Hrs Ambient temperature :+105°C Applied voltage :None														
	After test requirement at +20°C:Same limits as Endurance. Pre-treatment for measurements shall be conducted after application of DC working voltage for 30 minutes.														

Radial

Multiplier for Ripple Current vs. Frequency

Frequency(Hz)	120	1K	10K	10K≤
Multiplier	1.0	1.5	1.70	1.90

Diagram of Dimensions:(unit:mm)

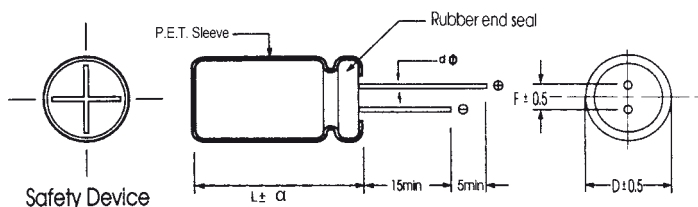

D φ	8	10	13	16	18
F	3.5	5.0	5.0	7.5	7.5
d φ	L < 20	L ≥ 20			
	0.5	0.6	0.6	0.8	
α	D < 18		D = 18		D > 18
	1.5		L < 35.5	L ≥ 35.5	
			1.5	2.0	2.0

Case Size

φ DxL(mm)

WV Cap(μF)	160		200		250		350		400		450	
	Size	Ripple	Size	Ripple	Size	Ripple	Size	Ripple	Size	Ripple	Size	Ripple
1.0							8X11.5	80	10X12.5	85	10X12.5	90
2.2							10X12.5	85	10X12.5	90	10X12.5	95
3.3					8X11.5	80	10X12.5	90	10X16	100	10X16	110
4.7					10X12.5	105	10X16	105	10X20	115	10X20	125
6.8			10X12.5	105	10X12.5	110	10X16	115	10X20	125	10X20	135
10	10X16	125	10X16	125	10X16	140	10X20	150	13X20	170	13X20	185
22	10X20	200	10X20	200	13X20	200	13X20	260	13X25	270	16X21	290
33	10X20	250	13X20	260	13X20	320	13X25	360	16X25	370	16X25	390
47	13X20	300	13X20	390	13X25	390	16X25	430	16X31.5	470	18X31.5	480
68	13X20	470	16X21	470	16X25	520	18X25	560	18X31.5	580	18X41	630
100	16X21	580	16X25	630	16X31.5	680	18X35.5	700	18X41	790	18X45	850
150	16X25	690	18X25	840	18X35.5	860	18X45	960				
220	18X31.5	980	18X35.5	1050	18X45	1130						
330	18X41	1250										

Ripple Current (mA, rms) at 105°C 120Hz

LE Series 105°C 10000~15000 hours

Features

- ◆ Ultra Long life
- ◆ For LED lighting
- ◆ ROHS compliant

FL → long life → LE

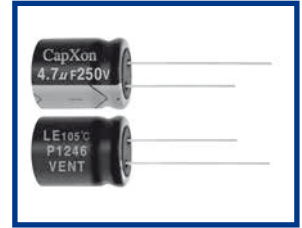

Specifications

Item	Performance Characteristics												
Operating Temperature Range	-25~+105°C												
Rated Voltage Range	160~450 VDC												
Capacitance Range	1 to 68 µF												
Capacitance Tolerance	±20%(120Hz,+20°C)												
Leakage Current (+20°C,max.)	<table border="1"> <tr> <td>(CV ≤ 1000)</td> <td>(CV > 1000)</td> <td rowspan="2">After 1minutewith ratedworking voltage applied. C:: ratedCapacitance (µ F) , V: working voltage(V)</td> </tr> <tr> <td>1 ≤ 0.1CV+40(µ A)</td> <td>1 ≤ 0.04CV+100(µ A)</td> </tr> </table>	(CV ≤ 1000)	(CV > 1000)	After 1minutewith ratedworking voltage applied. C:: ratedCapacitance (µ F) , V: working voltage(V)	1 ≤ 0.1CV+40(µ A)	1 ≤ 0.04CV+100(µ A)							
(CV ≤ 1000)	(CV > 1000)	After 1minutewith ratedworking voltage applied. C:: ratedCapacitance (µ F) , V: working voltage(V)											
1 ≤ 0.1CV+40(µ A)	1 ≤ 0.04CV+100(µ A)												
Dissipation Factor (tan δ , at 20°C , 120Hz)	<p>Less than the value under table</p> <table border="1"> <tr> <td>Cap(µ F) / W.v.(V)</td> <td>160~450</td> </tr> <tr> <td>tan δ</td> <td>24%</td> </tr> </table>	Cap(µ F) / W.v.(V)	160~450	tan δ	24%								
Cap(µ F) / W.v.(V)	160~450												
tan δ	24%												
Low Temperature Characteristics (at 120Hz)	<p>Impedance ratio max</p> <table border="1"> <tr> <td>Working voltage(V)</td> <td>≥ 250</td> <td>≥ 250</td> </tr> <tr> <td>Z-25°C / Z+20°C</td> <td>3</td> <td>6</td> </tr> </table>	Working voltage(V)	≥ 250	≥ 250	Z-25°C / Z+20°C	3	6						
Working voltage(V)	≥ 250	≥ 250											
Z-25°C / Z+20°C	3	6											
Endurance	<table border="1"> <tr> <td>Test condition</td> <td>Duration time :As right</td> <td>6.3X11,8X9,10X9</td> <td>10000hours</td> </tr> <tr> <td>Ambient temperature</td> <td>:+105°C</td> <td>8X11.5,10X12.5</td> <td>12000hours</td> </tr> <tr> <td>Applied voltage</td> <td>:Rated DC working voltage</td> <td>10X16 or more</td> <td>15000hours</td> </tr> </table> <p>After test requirement at +20°C Capacitance change : Within ±30% of the initial measured value Dissipation factor : Not more than 300% of the initial specified value Leakage current : Not more than The initial specified value</p>	Test condition	Duration time :As right	6.3X11,8X9,10X9	10000hours	Ambient temperature	:+105°C	8X11.5,10X12.5	12000hours	Applied voltage	:Rated DC working voltage	10X16 or more	15000hours
Test condition	Duration time :As right	6.3X11,8X9,10X9	10000hours										
Ambient temperature	:+105°C	8X11.5,10X12.5	12000hours										
Applied voltage	:Rated DC working voltage	10X16 or more	15000hours										
Shelf Life	<p>Test condition</p> <p>Duration time :1000 Hrs Ambient temperature :+105°C Applied voltage :None</p> <p>After test requirement at +20°C:Same limits as Endurance. Pre-treatment for measurements shall be conducted after application of DC working voltage for 30 minutes.</p>												

Radial

Multiplier for Ripple Current vs. Frequency

Frequency(Hz)		120	1K	10K	100K
Coefficient	1~5.6 µF	1.0	1.6	1.8	2.0
	6.8~18 µF	1.0	1.5	1.7	1.9
	22~33 µF	1.0	1.4	1.6	1.8

Diagram of Dimensions:(unit:mm)

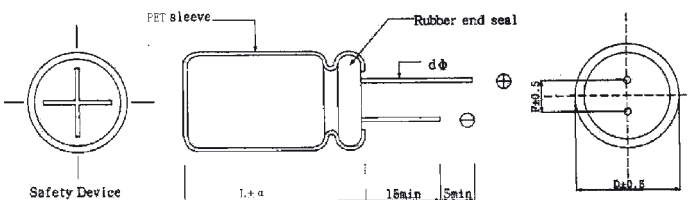

D φ	6.3	8	10	13	16	18
F	2.5	3.5	5.0	5.0	7.5	7.5
d φ	0.5		0.6		0.8	

α	D < 18	D = 18		D > 18
		L < 35.5	L ≥ 35.5	
	1.5	1.5	2.0	2.0

Case Size

φ DxL(mm)

Cap(μ F) \ WV	160		200		250	
	Size	Ripple	Size	Ripple	Size	Ripple
1						
1.2						
1.5						
1.8						
2.2			6.3x11	36	6.3x11	36
3.3			6.3x11	42	6.3x11	42
3.9						
4.7			6.3x11	49	8x9	53
5.6	6.3x11	52	8x9	56	8x11.5	62
6.8			8x9	62	8x11.5	68
8.2			8x9	66	10x9	76
10	8x9	70	8x11.5	80	10x12.5	90
12			10x9	88	10x12.5	97
15	8x11.5	92				
	10x9	95				
18			10x12.5	113	10x16	127
22	10x12.5	121				
27			10x16	149		
33	10x16	158				

Cap(μ F) \ WV	400		450	
	Size	Ripple	Size	Ripple
1	6.3x11	24		
1.2	8x9	28		
1.5	8x9	30		
1.8	8x9	33		
2.2	8x9	36		
	8x11.5	40		
2.7	8x11.5	43		
3.3	8x11.5	47		
	10x9	48		
3.9	10x12.5	57		
4.7	10x12.5	61	10x16	54
			10x20	66
6.8	10x16	85	10x20	84
8.2			10x20	84
10			13x20	135
15			13x25	180
			13x25	240
22			16x21	292
			16x25	312
33			18x21	312
			18x25	480
47			18x25	480
68			18x31.5	520

Ripple Current (mA, rms) at 105°C 120Hz

KY Series

Features

- ◆ Endurance: 105°C 2000hours.
- ◆ Suitable for slim application

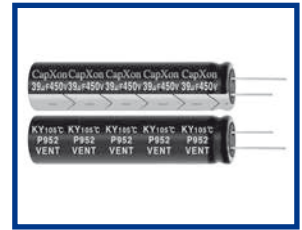

Specifications

Item	Performance Characteristics					
Operating Temperature Range	-25~+105°C					
Rated Voltage Range	250~450 VDC					
Capacitance Tolerance	±20%(120Hz,+20°C)					
Leakage Current (+20°C,max.)	$I \leq 3 \sqrt{CV}$ (μA) (After 5 minute with rated working voltage applied.) I= Leakage Current(μA) C= Rated Capacitance V= Rated voltage(V)					
Dissipation Factor (tan δ , at 20°C , 120Hz)	Working Voltage(VDC)	250	350	400	420	450
	D.F.(%)max.	15	15	15	20	20
Low Temperature Characteristics (at 120Hz)	Impedance ratio max					
	Working voltage(VDC)	250	350~450			
Endurance	Test condition					
	Duration time : 2000hrs Ambient temperature : +105°C Applied voltage : Rated DC working voltage After test requirement at +20°C Capacitance change : ≤ ±20% of the initial measured value Dissipation factor : ≤ 200% of the initial specified value Leakage current : ≤ The initial specified value					

Multiplier for Ripple Current vs. Frequency

Frequency(Hz)	60	120	400	1K	100K	
Coefficient	250~350WV	0.8	1.00	1.20	1.30	1.40
	400~450WV	0.8	1.00	1.25	1.40	1.50

Diagram of Dimensions:(unit:mm)

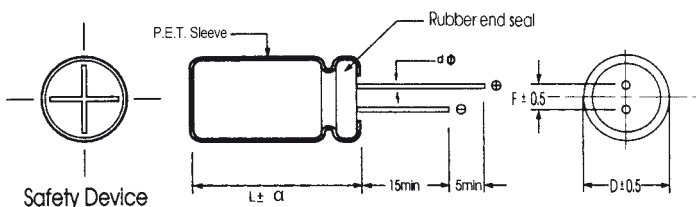

Dφ	8	10~13	
F	3.5	5.0	5.0
dφ	0.6	0.6	0.6
α	1.5	2.0	

Case Size

φ DxL(mm)

WV Cap(μF)	250		350		400		420		450	
	Size	Ripple	Size	Ripple	Size	Ripple	Size	Ripple	Size	Ripple
10										
12									8x30	135
15			8x30	145	8x30	170	8x30	150	8x35	150
22	8x30	200	8x35	185	8x35	220	8x35	195	8x40	195
									10x30	195
27	8x30	220	8x40	220	8x40	255	8x40	230	8x45	230
					10x30	255			10x30	220
33	8x30	240	8x40	250	8x45	280	8x50	300	10x35	255
					10x30	280	10x35	290	10x40	280
39	8x35	270	10x35	300	8x50	330	10x40	315	10x40	300
					10x35	330	13x30	315	10x45	315
									10x50	330
47	8x40	330	10x40	380	10x40	430	10x40	360	10x50	390
					13x30	430	13x30	360		
56	10x35	380	10x45	430	10x50	480	10x50	440	13x35	420
					13x30	450	13x30	400	13x40	450
68	10x35	435	13x35	480	10x55	550	13x35	470	13x40	520
					13x35	520			13x45	550
					13x40	550				
82	10x40	500	13x40	550	13x40	580	13x40	550	13x45	570
100	10x45	585	13x45	600	13x45	620	13x50	620		
					13x50	650				
120	13x35	620			13x55	750				
150	13x40	670								

Ripple Current (mA r.m.s) at 105°C,120Hz

LY Series

Features

- ◆ Endurance: 105°C 5000hours.
- ◆ Suitable for slim application

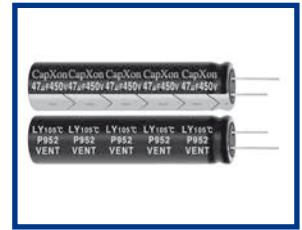

Specifications

Item	Performance Characteristics					
Operating Temperature Range	-25~+105°C					
Rated Voltage Range	250~450 VDC					
Capacitance Tolerance	±20%(120Hz,+20°C)					
Leakage Current (+20°C,max.)	$I \leq 3 \sqrt{CV}$ (µA) (After 5 minute with rated working voltage applied.) I= Leakage Current(µA) C= Rated Capacitance V= Rated voltage(V)					
Dissipation Factor (tan δ , at 20°C , 120Hz)	Working Voltage(VDC)	250	350	400	420	450
	D.F.(%)max.	15	15	15	20	20
Low Temperature Characteristics (at 120Hz)	Impedance ratio max					
	Working voltage(VDC)	250	350~450			
Endurance	Test condition					
	Duration time	: 5000hrs				
Endurance	Ambient temperature	: +105°C				
	Applied voltage	: Rated DC working voltage				
Endurance	After test requirement at +20°C					
	Capacitance change	: ≤ ±20% of the initial measured value				
	Dissipation factor	: ≤200% of the initial specified value				
	Leakage current	: ≤The initial specified value				

Multiplier for Ripple Current vs. Frequency

Frequency(Hz)	60	120	400	1K	100K	
Coefficient	250~350WV	0.8	1.00	1.20	1.30	1.40
	400~450WV	0.8	1.00	1.25	1.40	1.50

Diagram of Dimensions:(unit:mm)

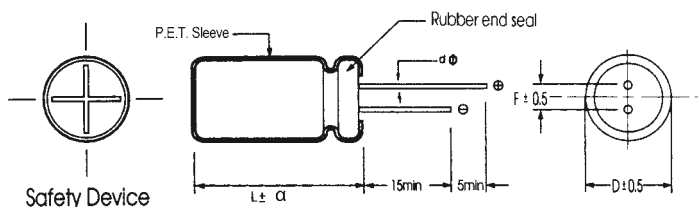

Dφ	8	10~13	
F	3.5	5.0	5.0
dφ	0.6	0.6	0.6
α	1.5	2.0	

Case Size

φ DxL(mm)

WV Cap(μF)	250		350		400		420		450	
	Size	Ripple	Size	Ripple	Size	Ripple	Size	Ripple	Size	Ripple
10										
12									8x30	110
15			8x30	110	8x30	120	8x30	100	8x35	120
22	8x30	130	8x35	150	8x35	160	8x40	180	8x45	160
									10x30	150
27	8x30	150	8x40	165	8x40	195	8x45	200	8x50	190
					10x30	195			10x35	180
33	8x35	170	8x45	195	8x45	250	10x35	230	10x40	220
					10x30	250			10x45	235
									10x50	250
39	8x40	200	10x40	280	8x50	280	10x45	275	10x45	260
					10x40	300	13x30	275	10x50	290
									13x35	290
47	8x45	220	10x45	330	10x45	350	10x45	330	10x55	350
					13x30	330	13x35	360	13x35	350
56	10x35	260	10x50	380	10x50	400	10x55	420	13x35	400
	10x40	300			13x30	380	13x35	410	13x40	425
					13x35	420				
68	10x40	350	13x35	425	13x35	440	13x40	450	13x45	470
			13x40	450	13x40	460			13x50	500
82	10x45	480	13x40	500	13x45	520	13x45	500	13x50	530
100	10x50	550	13x50	520	13x50	580	13x50	600		
120	13x40	570			13x60	680				
150	13x45	620								

Ripple Current (mA r.m.s) at 105°C,120Hz

HY Series

Features

- ◆ Endurance: 105°C 10000hours.
- ◆ Suitable for slim application
- ◆ High ripple current

LY Long life, high ripple current → HY

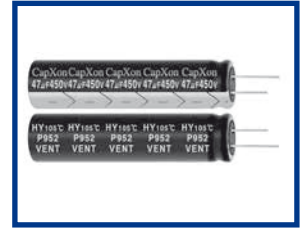

Specifications

Item	Performance Characteristics		
Operating Temperature Range	-25 to +105°C		
Rated Voltage Range	250~450VDC		
Capacitance Range	12 ~120 μ F		
Capacitance Tolerance	±20%(120Hz,+20°C)		
Leakage Current (+20°C,max.)	$I \leq 3 \sqrt{CV}$ (μA) (After 5 minute with rated working voltage applied.) I= Leakage Current(μA) C= Rated Capacitance V= Rated voltage(V)		
Dissipation Factor (tan δ , at 20°C , 120Hz)	Working Voltage(VDC)	250~400	420~450
	D.F.(%)max.	20	25
Low Temperature Characteristics (at 120Hz)	Impedance ratio max		
	Working voltage(VDC)	250	350~450
Endurance	Z-25°C / Z+20°C	3	8
	Test condition Duration time : 10000hrs Ambient temperature : +105°C Applied voltage : Rated DC working voltage After test requirement at +20°C Capacitance change : ≤ ±20% of the initial measured value Dissipation factor : ≤ 200% of the initial specified value Leakage current : ≤ The initial specified value		

Multiplier for Ripple Current vs. Frequency

Frequency(Hz)		60	120	400	1K	100K
Coefficient	250~350WV	0.8	1.00	1.20	1.30	1.40
	400~450WV	0.8	1.00	1.25	1.40	1.50

Diagram of Dimensions:(unit:mm)

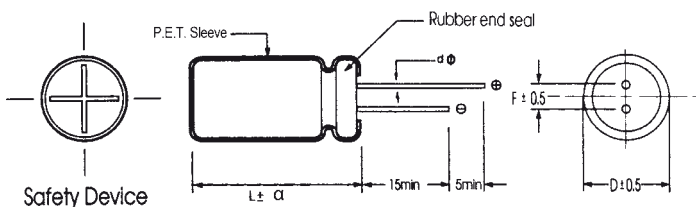

Dφ	8	10~13	14.5
F	3.5	5.0	7.5
dφ	0.6	0.6	0.8
α	1.5	2.0	

Case Size

φ DxL(mm)

WV Cap(μF)	250		350		400		420		450	
	Size	Ripple	Size	Ripple	Size	Ripple	Size	Ripple	Size	Ripple
12			8x30	100	8x30	130	8x30	140	8x30	150
15			8x35	130	8x35	180	8x35	170	8x40	190
22	8x35	140	8x40	165	8x45	230	8x50	250	10x30	220
27	8x40 10x30	165 165	10x30	185	10x30	240	10x35	270	10x40	280
33	10x30	180	10x35	200	10x35	290	10x40	370	10x40 13x30	360 370
39	10x35	210	10x40 13x30	285 285	10x40 13x30	400 400	10x45 13x30	410 390	10x50 13x35	410 420
47	10x40 13x30	280 260	10x45 13x30	340 330	10x45 13x30	450 440	10x50 13x35	420 450	10x50 13x40	420 480
56	10x45 13x35	330 330	10x50 13x35	380 360	10x50 13x35	520 500	10x60 13x40	530 520	13x45	530
68	10x50 13x35	380 370	10x60 13x40	450 430	13x40	580	13x45	580	13x50	620
82	10x60 13x40	490 465	13x45	520	13x45	650	13x50	660	13x55	680
100	13x45	500	13x50	580	13x50	680				
120	13x50	580								

Ripple Current (mA r.m.s) at 105°C, 120Hz

NP Series Non-polarized 85°C

Features

- ◆ NP Series for crossover networks of high-pitched, mean and low-pitched sounds in high-fidelity sound systems.
- ◆ The series offers excellent frequency characteristics and minimal capacitance deviation with frequency.
- ◆ RoHS Compliant

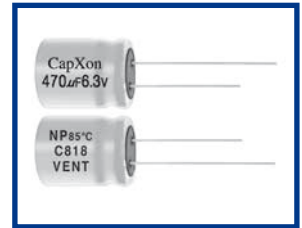

Specifications

Item	Performance Characteristics																																				
Operating Temperature Range	-40 to +85°C	-25 to +85°C																																			
Rated Voltage Range	6.3 to 100 VDC	160 to 250 VDC																																			
Capacitance Range	0.47 to 3300 µF	0.47 to 47 µF																																			
Capacitance Tolerance	±20%(120Hz,+20°C)																																				
Leakage Current (+20°C,max.)	I ≤ 0.03 CV or 3 (µA) After 1 minute whichever is greater measured with rated working voltage applied.																																				
Dissipation Factor (tan δ , at 20°C , 120Hz)	<table border="1"> <tr> <td>Working Voltage(VDC)</td> <td>6.3</td> <td>10</td> <td>16</td> <td>25</td> <td>35</td> <td>50</td> <td>63</td> <td>100</td> <td>160</td> <td>200</td> <td>250</td> </tr> <tr> <td>D.F. (%)max.</td> <td>25</td> <td>25</td> <td>20</td> <td>15</td> <td>15</td> <td>13</td> <td>10</td> <td>10</td> <td>15</td> <td>15</td> <td>20</td> </tr> </table> <p>For Capacitance > 1000 uF, add 2% per another 1000 uF</p>		Working Voltage(VDC)	6.3	10	16	25	35	50	63	100	160	200	250	D.F. (%)max.	25	25	20	15	15	13	10	10	15	15	20											
Working Voltage(VDC)	6.3	10	16	25	35	50	63	100	160	200	250																										
D.F. (%)max.	25	25	20	15	15	13	10	10	15	15	20																										
Low Temperature Characteristics (at 120Hz)	<p>Impedance ratio max</p> <table border="1"> <tr> <td>Working Voltage(VDC)</td> <td>6.3</td> <td>10</td> <td>16</td> <td>25</td> <td>35</td> <td>50</td> <td>63</td> <td>100</td> </tr> <tr> <td>Z-25°C / Z+20°C</td> <td>4</td> <td>3</td> <td>2</td> <td>2</td> <td>2</td> <td>2</td> <td>2</td> <td>2</td> </tr> <tr> <td>Z-40°C / Z+20°C</td> <td>8</td> <td>6</td> <td>4</td> <td>4</td> <td>3</td> <td>3</td> <td>3</td> <td>3</td> </tr> </table> <table border="1"> <tr> <td>Working Voltage(VDC)</td> <td>160</td> <td>200</td> <td>250</td> </tr> <tr> <td>Z-25°C / Z+20°C</td> <td>2</td> <td>2</td> <td>3</td> </tr> </table> <p>For Capacitance > 1000 uF, add 0.5 per another 1000 uF for -25°C / +20°C add 1 per another 1000 uF for -40°C / +20°C</p>		Working Voltage(VDC)	6.3	10	16	25	35	50	63	100	Z-25°C / Z+20°C	4	3	2	2	2	2	2	2	Z-40°C / Z+20°C	8	6	4	4	3	3	3	3	Working Voltage(VDC)	160	200	250	Z-25°C / Z+20°C	2	2	3
Working Voltage(VDC)	6.3	10	16	25	35	50	63	100																													
Z-25°C / Z+20°C	4	3	2	2	2	2	2	2																													
Z-40°C / Z+20°C	8	6	4	4	3	3	3	3																													
Working Voltage(VDC)	160	200	250																																		
Z-25°C / Z+20°C	2	2	3																																		
Endurance	<p>Test conditions</p> <p>Duration time : 2000Hrs</p> <p>Ambient temperature : +85°C</p> <p>Applied voltage : Rated DC working voltage</p> <p>Each 250 hours, we will reserve the terminal and test the characteristics.</p> <p>After test requirements at +20°C</p> <p>Capacitance change : ≤ ±20% of the initial measured value</p> <p>Dissipation factor : ≤ 150% of the initial specified value</p> <p>Leakage current : ≤ The initial specified value</p>																																				
Shelf Life	<p>Test conditions</p> <p>Duration time : 1000Hrs</p> <p>Ambient temperature : +85°C</p> <p>Applied voltage : None</p> <p>After test requirements at +20°C: Same limits as Endurance.</p> <p>Pre-treatment for measurements shall be conducted after application of DC working voltage for 30 minutes.</p>																																				

Multiplier for Ripple Current vs. Frequency

CAP (µ F) \ Frequency(Hz)	50(60)	120	400	1K	10K	50K-100K
CAP ≤ 10	0.8	1	1.30	1.45	1.65	1.70
10 < CAP ≤ 100	0.8	1	1.23	1.36	1.48	1.53
100 < CAP ≤ 1000	0.8	1	1.16	1.25	1.35	1.38
1000 < CAP	0.8	1	1.11	1.17	1.25	1.28

Diagram of Dimensions:(unit:mm)

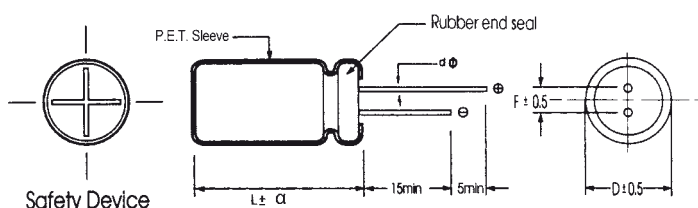

D φ	5	6.3	8	10	13	16	18
F	2.0	2.5	3.5	5.0	5.0	7.5	7.5
d φ	0.5		L < 20 0.5	L ≥ 20 0.6	0.6		0.8

α	D < 18		D = 18	
	1.5		L < 35.5 1.5	L ≥ 35.5 2.0

Case Size

WV Cap(μF)		6.3		10		16		25		35	
		Size	Ripple	Size	Ripple	Size	Ripple	Size	Ripple	Size	Ripple
10								5x11	34	5x11	43
22				5x11	55	5x11	57	6.3x11	65	6.3x11	75
33				5x11	66	5x11	75	6.3x11	86	8x11.5	105
47				5x11	82	6.3x11	97	6.3x11	100	8x11.5	120
100	6.3x11	120	6.3x11	125	8x11.5	162	8x11.5	175	10x12.5	10x16	210
220	6.3x11	175	8x11.5	205	10x12.5	270	10x12.5	295	10x20	400	
330	8x11.5	250	10x12.5	270	10x16	350	10x20	440	13x20	495	
470	10x12.5	330	10x16	388	10x20	455	13x20	530	13x25	655	
1000	10x20	650	13x20	700	13x20	730	13x25	800			
2200	13x20	850	16x25	1000	16x31.5	1100					
3300	16x25	970	18x35.5	1300							

φ DxL(mm)

WV Cap(μF)		50		63		100		160	
		Size	Ripple	Size	Ripple	Size	Ripple	Size	Ripple
0.47	5x11	11	5x11	12	5x11	14	5x11	17	
1	5x11	17	5x11	18	5x11	21	6.3x11	25	
2.2	5x11	25	5x11	26	5x11	34	8x11.5	38	
3.3	5x11	27	6.3x11	28	6.3x11	39	8x11.5	43	
4.7	5x11	34	6.3x11	34	8x11.5	47	10x12.5	52	
10	6.3x11	52	6.3x11	57	8x11.5	71	10x16	89	
22	8x11.5	92	8x11.5	97	10x16	140	13x20	155	
33	8x11.5	109	10x12.5	140	10x16	190	13x20	230	
47	10x12.5	150	10x16	180	10x20	220	13x25	250	
100	10x20	265	13x20	320	16x25	425			
220	13x20	475	13x25	510	16x25	520			
330	13x25	560			16x31.5	550			

WV Cap(μF)		200		250	
		Size	Ripple	Size	Ripple
0.47	6.3x11	21	6.3x11	28	
1	8x11.5	28	8x11.5	32	
2.2	8x11.5	42	10x12.5	48	
3.3	10x12.5	46	10x16	57	
4.7	10x16	56	10x20	88	
10	10x20	95	10x20	130	
22	13x20	180	13x25	224	
33	13x25	250	16x25	305	

Ripple Current (mA, rms) at 85°C 120Hz

NK Series Non-polarized 105°C

Features

- ◆ NK Series for crossover networks of high-pitched, mean and low-pitched sounds in high-fidelity sound systems.
- ◆ The series offers excellent frequency characteristics and minimal capacitance deviation with frequency.
- ◆ RoHS Compliant

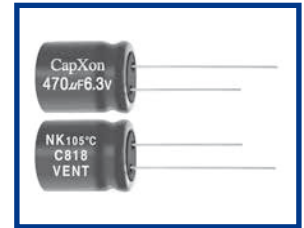

Specifications

Item	Performance Characteristics																																				
Operating Temperature Range	-40 to +105°C	-25 to +105°C																																			
Rated Voltage Range	6.3 to 100 VDC	160 to 250 VDC																																			
Capacitance Range	0.47 to 3300 µF	0.47 to 47 µF																																			
Capacitance Tolerance	±20%(120Hz,+20°C)																																				
Leakage Current (+20°C,max.)	I ≤ 0.03 CV or 3(µA) After 1 minute whichever is greater measured with rated working voltage applied.																																				
Dissipation Factor (tan δ , at 20°C , 120Hz)	<table border="1"> <tr> <th>Working Voltage(VDC)</th> <td>6.3</td><td>10</td><td>16</td><td>25</td><td>35</td><td>50</td><td>63</td><td>100</td><td>160</td><td>200</td><td>250</td> </tr> <tr> <th>D.F. (%)max.</th> <td>25</td><td>25</td><td>20</td><td>15</td><td>15</td><td>13</td><td>10</td><td>10</td><td>15</td><td>15</td><td>20</td> </tr> </table> <p>For Capacitance > 1000 uF, add 2% per another 1000 uF</p>		Working Voltage(VDC)	6.3	10	16	25	35	50	63	100	160	200	250	D.F. (%)max.	25	25	20	15	15	13	10	10	15	15	20											
Working Voltage(VDC)	6.3	10	16	25	35	50	63	100	160	200	250																										
D.F. (%)max.	25	25	20	15	15	13	10	10	15	15	20																										
Low Temperature Characteristics (at 120Hz)	<p>Impedance ratio max</p> <table border="1"> <tr> <th>Working Voltage(VDC)</th> <td>6.3</td><td>10</td><td>16</td><td>25</td><td>35</td><td>50</td><td>63</td><td>100</td> </tr> <tr> <th>Z-25°C / Z+20°C</th> <td>4</td><td>3</td><td>2</td><td>2</td><td>2</td><td>2</td><td>2</td><td>2</td> </tr> <tr> <th>Z-40°C / Z+20°C</th> <td>8</td><td>6</td><td>4</td><td>3</td><td>3</td><td>3</td><td>3</td><td>3</td> </tr> </table> <table border="1"> <tr> <th>Working Voltage(VDC)</th> <td>160</td><td>200</td><td>250</td> </tr> <tr> <th>Z-25°C / Z+20°C</th> <td>2</td><td>2</td><td>3</td> </tr> </table> <p>For Capacitance > 1000 uF, add 0.5 per another 1000 uF for -25°C / +20°C add 1 per another 1000 uF for -40°C / +20°C</p>		Working Voltage(VDC)	6.3	10	16	25	35	50	63	100	Z-25°C / Z+20°C	4	3	2	2	2	2	2	2	Z-40°C / Z+20°C	8	6	4	3	3	3	3	3	Working Voltage(VDC)	160	200	250	Z-25°C / Z+20°C	2	2	3
Working Voltage(VDC)	6.3	10	16	25	35	50	63	100																													
Z-25°C / Z+20°C	4	3	2	2	2	2	2	2																													
Z-40°C / Z+20°C	8	6	4	3	3	3	3	3																													
Working Voltage(VDC)	160	200	250																																		
Z-25°C / Z+20°C	2	2	3																																		
Endurance	<p>Test conditions</p> <p>Duration time : 2000Hrs</p> <p>Ambient temperature : +105°C</p> <p>Applied voltage : Rated DC working voltage</p> <p>Each 250 hours, we will reserve the terminal and test the characteristics.</p> <p>After test requirement at +20°C</p> <p>Capacitance change : ≤ ±20% of the initial measured value</p> <p>Dissipation factor : ≤ 150% of the initial specified value</p> <p>Leakage current : ≤ The initial specified value</p>																																				
Shelf Life	<p>Test conditions</p> <p>Duration time : 1000Hrs</p> <p>Ambient temperature : +105°C</p> <p>Applied voltage : None</p> <p>After test requirement at +20°C: Same limits as Endurance.</p> <p>Pre-treatment for measurements shall be conducted after application of DC working voltage for 30 minutes.</p>																																				

Radial

Multiplier for Ripple Current vs. Frequency

CAP(µF) \ Frequency(Hz)	50(60)	120	400	1K	10K	50K-100K
CAP ≤ 10	0.8	1	1.30	1.45	1.65	1.70
10 < CAP ≤ 100	0.8	1	1.23	1.36	1.48	1.53
100 < CAP ≤ 1000	0.8	1	1.16	1.25	1.35	1.38

Diagram of Dimensions:(unit:mm)

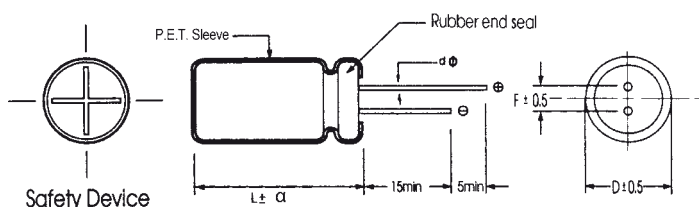

D φ	5	6.3	8		10	13	16	18
F	2.0	2.5	3.5		5.0	5.0	7.5	7.5
d φ	0.5		L < 20 0.5	L ≥ 20 0.6	0.6		0.8	

α	D < 18	D = 18	
	1.5	L < 35.5	L ≥ 35.5
		1.5	2.0

Case Size

φ DxDL(mm)

WV Cap(μF)	6.3		10		16		25		35	
	Size	Ripple	Size	Ripple	Size	Ripple	Size	Ripple	Size	Ripple
10							5x11	34	5x11	38
22					5x11	53	6.3x11	55	6.3x11	65
33			5x11	59	5x11	62	6.3x11	72	8x11.5	75
47			5x11	79	6.3x11	90	6.3x11	96	8x11.5	107
100	5x11	99	6.3x11	99	6.3x11	99	8x11.5	152	10x12.5	198
					8x11.5	123				
220	8x11.5	149	8x11.5	157	8x11.5	200	10x12.5	245	10x20	320
					10x12.5	234				
330	8x11.5	190	10x12.5	235	10x12.5	255	10x16	310	13x20	370
470	10x12.5	280	10x12.5	290	10x16	360	13x20	420	13x25	495
1000	10x16	352	10x20	430	13x20	511				
2200	13x20	645	16x25	830	16x31.5	950				
3300	16x25	950	16x31.5	1150						

WV Cap(μF)	50		63		100		160	
	Size	Ripple	Size	Ripple	Size	Ripple	Size	Ripple
0.47	5x11	8	5x11	9	5x11	10	5x11	12
1	5x11	12	5x11	14	5x11	15	6.3x11	18
2.2	5x11	17	5x11	20	5x11	20	8x11.5	28
					6.3x11	22		
3.3	5x11	23	6.3x11	25	6.3x11	28	8x11.5	37
4.7	5x11	30	6.3x11	30	6.3x11	32	10x12.5	45
					8x11.5	36		
10	6.3x11	50	6.3x11	52	8x11.5	52	10x16	79
					10x12.5	55		
22	8x11.5	85	8x11.5	88	10x16	120	13x20	140
			10x12.5	92				
33	8x11.5	89	10x12.5	115	10x20	175	13x20	200
47	10x12.5	123	10x16	150	13x20	187	13x25	215
100	10x16	198	13x20	295	16x25	399		
	10x20	220						
220	13x20	340	13x25	420				
	13x25	375						
330	16x25	500						

WV Cap(μF)	200		250	
	Size	Ripple	Size	Ripple
0.47	6.3x11	17	6.3x11	22
1	8x11.5	21	8x11.5	25
2.2	8x11.5	32	10x12.5	39
3.3	10x12.5	40	10x16	43
4.7	10x16	52	10x20	65
10	10x20	86	10x20	109
22	13x20	160	13x25	189
33	13x25	213	16x25	250

Ripple Current (mA, rms) at 105°C 120Hz

BP Series Bi-polarized

Features

- ◆ The BP Series is designed for horizontal deflection current in TV sets where high frequency and high ripple current flows.
- ◆ Low dissipation factor at high frequency.
- ◆ RoHS Compliant

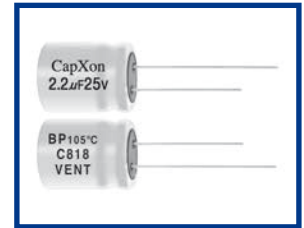

Specifications

Item	Performance Characteristics								
Operating Temperature Range	-40 to +105°C								
Rated Voltage Range	25,50,63 VDC								
Capacitance Range	2.2 to 15 µF								
Capacitance Tolerance	± 10% (120Hz, +20°C)								
Leakage Current (+20°C,max.)	I ≤ 100 (µA) After 1 minute with rated working voltage applied.								
Dissipation Factor (tan δ · at 20°C · 120Hz)	Less than 3% (+20°C,at 120Hz)								
Low Temperature Characteristics (at 120Hz)	Impedance ratio max <table border="1"> <thead> <tr> <th>Working Voltage (VDC)</th> <th>25</th> <th>50</th> <th>63</th> </tr> </thead> <tbody> <tr> <td>Z-40°C / Z+20°C</td> <td>4</td> <td>4</td> <td>4</td> </tr> </tbody> </table>	Working Voltage (VDC)	25	50	63	Z-40°C / Z+20°C	4	4	4
Working Voltage (VDC)	25	50	63						
Z-40°C / Z+20°C	4	4	4						
Endurance	Test conditions Duration time :2000Hrs Ambient temperature :+105°C Applied voltage :Rated DC working voltage After test requirement at +20°C Capacitance change :≤ ± 15% of the initial measured value Dissipation factor :≤ 150% of the initial specified value Leakage current :≤ The initial specified value								
Shelf Life	Test conditions Duration time :1000Hrs Ambient temperature :+105°C Applied voltage :None After test requirement at +20°C:Same limits as Endurance. Pre-treatment for measurements shall be conducted after application of DC working voltage for 30 minutes.								

Diagram of Dimensions:(unit:mm)

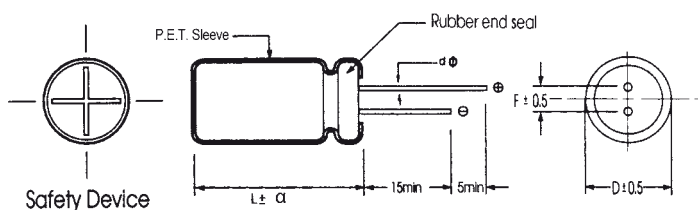

D φ	10	13	16	18	22
F	5.0	5.0	7.5	7.5	10
d φ	0.6		0.8		

α	D < 18	D = 18		D > 18
		L < 35.5	L ≥ 35.5	
	1.5	1.5	2.0	2.0

Case Size

Cap(μ F)	Size	WV	Max Ripple Current (at 15.75K Hz Unit:A P-P)		
			105°C	85°C	70°C
2.2	13x25	25v, 50v, 63v	3.4a p-p	5.8 a p-p	7.5 a p-p
3.3	16x25	25v, 50v, 63v	4.1a p-p	7.0 a p-p	9.1 a p-p
4.7	16x31.5	25v, 50v, 63v	4.5 a p-p	7.8 a p-p	10 a p-p
6.8	16x35.5	25v, 50v, 63v	4.6 a p-p	8.0 a p-p	10.4 a p-p
10	18x35.5	25v, 50v, 63v	4.9 a p-p	8.6 a p-p	11.1 a p-p
12	18x41	25v, 50v, 63v	5.0 a p-p	8.8 a p-p	11.5 a p-p
15	18x41	25v, 50v, 63v	5.4 a p-p	9.5 a p-p	12.2 a p-p

ϕ DxL(mm)

Ripple Current (A, rms) at 15.75KHz

SW Series 5mm 85°C

Features

- ◆ Design for audio equipment.
- ◆ RoHS Compliant

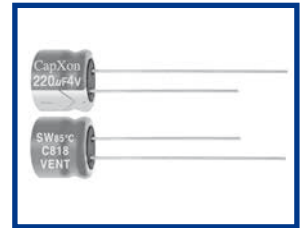

Specifications

Item	Performance Characteristics																								
Operating Temperature Range	-40~+85°C																								
Rated Voltage Range	4~50 VDC																								
Capacitance Range	0.1 to 470 µF																								
Capacitance Tolerance	±20%(120Hz,+20°C)																								
Leakage Current (+20°C,max.)	I=0.01 CV or 3 (µA) (After 2 minute with rated working voltage applied.)																								
Dissipation Factor (tan δ , at 20°C , 120Hz)	<table border="1"> <tr> <td>Working Voltage(VDC)</td> <td>4</td> <td>6.3</td> <td>10</td> <td>16</td> <td>25</td> <td>35</td> <td>50</td> </tr> <tr> <td>D.F.(%)max.</td> <td>35</td> <td>24</td> <td>20</td> <td>16</td> <td>14</td> <td>12</td> <td>10</td> </tr> </table>	Working Voltage(VDC)	4	6.3	10	16	25	35	50	D.F.(%)max.	35	24	20	16	14	12	10								
	Working Voltage(VDC)	4	6.3	10	16	25	35	50																	
D.F.(%)max.	35	24	20	16	14	12	10																		
Low Temperature Characteristics (at 120Hz)	Impedance ratio max																								
	<table border="1"> <tr> <td>Working voltage(VDC)</td> <td>4</td> <td>6.3</td> <td>10</td> <td>16</td> <td>25</td> <td>35</td> <td>50</td> </tr> <tr> <td>Z-25°C / Z+20°C</td> <td>7</td> <td>4</td> <td>3</td> <td>2</td> <td>2</td> <td>2</td> <td>2</td> </tr> <tr> <td>Z-40°C / Z+20°C</td> <td>15</td> <td>8</td> <td>6</td> <td>4</td> <td>4</td> <td>3</td> <td>3</td> </tr> </table>	Working voltage(VDC)	4	6.3	10	16	25	35	50	Z-25°C / Z+20°C	7	4	3	2	2	2	2	Z-40°C / Z+20°C	15	8	6	4	4	3	3
	Working voltage(VDC)	4	6.3	10	16	25	35	50																	
Z-25°C / Z+20°C	7	4	3	2	2	2	2																		
Z-40°C / Z+20°C	15	8	6	4	4	3	3																		
Endurance	Test condition Duration time :1000 Hrs Ambient temperature :+85°C Applied voltage :Rated DC working voltage After test requirement at +20°C Capacitance change : ≤ ±20% of the initial measured value Dissipation factor : ≤ 200% of the initial specified value Leakage current : ≤ The initial specified value																								
Shelf Life	Test condition Duration time :1000 Hrs Ambient temperature :+85°C Applied voltage :None After test requirement at +20°C :Same limits as Endurance. Pre-treatment for measurements shall be conducted after application of DC working voltage for 30 minutes.																								

For Audio Equipment

Multiplier for Ripple Current vs. Frequency

CAP(µF)\Frequency(Hz)	50	120	300	1K	10K
Multiplier	0.70	1.00	1.17	1.36	1.50

Diagram of Dimension:(unit:mm)

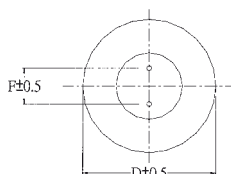
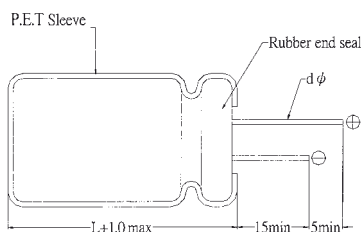

D φ	4	5	6.3	8
F	1.5	2.0	2.5	3.5
d φ	0.45			0.50

Case Size

φ DxL(mm)

Cap(μF)	WV	4		6.3		10		16		25		35		50	
		Size	Ripple	Size	Ripple	Size	Ripple	Size	Ripple	Size	Ripple	Size	Ripple	Size	Ripple
0.1														4×5	1.2
0.22														4×5	2.3
0.33														4×5	3.0
0.47														4×5	3.9
1														4×5	7.3
2.2														4×5	11
3.3												4×5	13	4×5	15
4.7										4×5	15	4×5	18	5×5	20
10								4×5	21	5×5	27	5×5	29	6.3×5	31
22				4×5	26	5×5	33	5×5	36	6.3×5	43	6.3×5	46	8×5	52
33		4×5	30	5×5	37	5×5	40	6.3×5	47	6.3×5	52	8×5	62	8×5	70
47		4×5	33	5×5	42	6.3×5	49	6.3×5	58	8×5	70	8×5	81		
100		5×5	54	6.3×5	67	8×5	80	8×5	92	8×5	109				
220		6.3×5	87	8×5	112	8×5	136								
330		8×5	143	8×5	170										
470		8×5	185												

Ripple Current (mA, rms) at 85°C 120Hz

SR Series 7mm 85°C

Features

- ◆ Design for audio equipment.
- ◆ Lineally suited for very compact audio products.
- ◆ RoHS Compliant

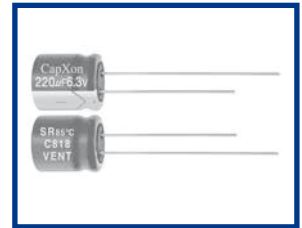

Specifications

Item	Performance Characteristics																					
Operating Temperature Range	-40~+85°C																					
Rated Voltage Range	6.3~50 VDC																					
Capacitance Range	0.1 to 220 µ F																					
Capacitance Tolerance	±20%(120Hz,+20°C)																					
Leakage Current (+20°C,max.)	I=0.01 CV or 3 (µ A) (After 2 minute with rated working voltage applied.)																					
Dissipation Factor (tan δ , at 20°C , 120Hz)	<table border="1"> <tr> <td>Working Voltage(VDC)</td> <td>6.3</td> <td>10</td> <td>16</td> <td>25</td> <td>35</td> <td>50</td> </tr> <tr> <td>D.F.(%)max.</td> <td>24</td> <td>20</td> <td>16</td> <td>14</td> <td>12</td> <td>10</td> </tr> </table>	Working Voltage(VDC)	6.3	10	16	25	35	50	D.F.(%)max.	24	20	16	14	12	10							
	Working Voltage(VDC)	6.3	10	16	25	35	50															
D.F.(%)max.	24	20	16	14	12	10																
Low Temperature Characteristics (at 120Hz)	Impedance ratio max																					
	<table border="1"> <tr> <td>Working voltage(VDC)</td> <td>6.3</td> <td>10</td> <td>16</td> <td>25</td> <td>35</td> <td>50</td> </tr> <tr> <td>Z-25°C / Z+20°C</td> <td>4</td> <td>3</td> <td>2</td> <td>2</td> <td>2</td> <td>2</td> </tr> <tr> <td>Z-40°C / Z+20°C</td> <td>8</td> <td>6</td> <td>4</td> <td>4</td> <td>3</td> <td>3</td> </tr> </table>	Working voltage(VDC)	6.3	10	16	25	35	50	Z-25°C / Z+20°C	4	3	2	2	2	2	Z-40°C / Z+20°C	8	6	4	4	3	3
	Working voltage(VDC)	6.3	10	16	25	35	50															
Z-25°C / Z+20°C	4	3	2	2	2	2																
Z-40°C / Z+20°C	8	6	4	4	3	3																
Endurance	Test condition Duration time :1000 Hrs Ambient temperature :+85°C Applied voltage :Rated DC working voltage After test requirement at +20°C Capacitance change : ≤ ±20% of the initial measured value Dissipation factor : ≤200% of the initial specified value Leakage current : ≤The initial specified value																					
Shelf Life	Test condition Duration time :1000 Hrs Ambient temperature :+85°C Applied voltage :None After test requirement at +20°C:Same limits as Endurance. Pre-treatment for measurements shall be conducted after application of DC working voltage for 30 minutes.																					

For Audio Equipment

Multiplier for Ripple Current vs. Frequency

CAP (µ F)\Frequency(Hz)	50	120	300	1K	10K
Multiplier	0.70	1.00	1.17	1.36	1.50

Diagram of Dimension:(unit:mm)

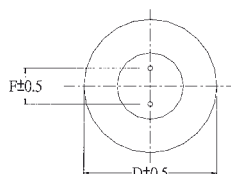
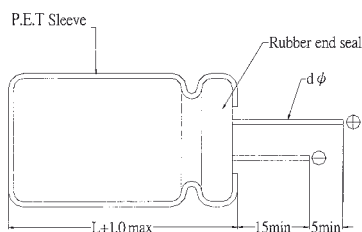

D φ	4	5	6.3
F	1.5	2.0	2.5
d φ	0.45		0.50

Case Size

φ DxL(mm)

Cap (μ F)	WV	6.3		10		16		25		35		50	
		Size	Ripple	Size	Ripple	Size	Ripple	Size	Ripple	Size	Ripple	Size	Ripple
0.1												4×7	1.1
0.22												4×7	2.6
0.33												4×7	3.5
0.47												4×7	5.0
1												4×7	10
2.2												4×7	18
3.3												4×7	23
4.7										4×7	23	4×7	26
10						4×7	28	4×7	29	4×7	31	5×7	35
22		4×7	34	4×7	35	4×7	39	5×7	49	5×7	49	6.3×7	58
33		4×7	40	4×7	45	5×7	55	5×7	55	6.3×7	65		
47		4×7	47	5×7	59	5×7	65	6.3×7	71				
100		5×7	76	6.3×7	88	6.3×7	98						
220		6.3×7	124										

Ripple Current (mA, rms) at 85°C 120Hz

RW Series 85°C

Features

- ◆ Standard for audio equipment.
- ◆ RoHS Compliant

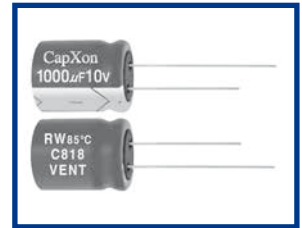

Specifications

Item	Performance Characteristics																											
Operating Temperature Range	-40~+85°C																											
Rated Voltage Range	6.3~100 VDC																											
Capacitance Range	0.1 to 33000 µ F																											
Capacitance Tolerance	±20%(120Hz,+20°C)																											
Leakage Current (+20°C,max.)	$I \leq 0.01 CV$ or 3 (µ A) (After 1 minute with rated working voltage applied.)																											
Dissipation Factor (tan δ , at 20°C , 120Hz)	<table border="1"> <tr> <td>Working Voltage(VDC)</td> <td>6.3</td> <td>10</td> <td>16</td> <td>25</td> <td>35</td> <td>50</td> <td>63</td> <td>100</td> </tr> <tr> <td>D.F.(%)max.</td> <td>28</td> <td>24</td> <td>20</td> <td>16</td> <td>14</td> <td>12</td> <td>10</td> <td>8</td> </tr> </table>	Working Voltage(VDC)	6.3	10	16	25	35	50	63	100	D.F.(%)max.	28	24	20	16	14	12	10	8									
	Working Voltage(VDC)	6.3	10	16	25	35	50	63	100																			
D.F.(%)max.	28	24	20	16	14	12	10	8																				
For capacitance > 1000 µ F, add 2% per another 1000 µ F.																												
Low Temperature Characteristics (at 120Hz)	Impedance ratio max																											
	<table border="1"> <tr> <td>Working voltage(VDC)</td> <td>6.3</td> <td>10</td> <td>16</td> <td>25</td> <td>35</td> <td>50</td> <td>63</td> <td>100</td> </tr> <tr> <td>Z-25°C / Z+20°C</td> <td>5</td> <td>4</td> <td>3</td> <td>2</td> <td>2</td> <td>2</td> <td>2</td> <td>2</td> </tr> <tr> <td>Z-40°C / Z+20°C</td> <td>12</td> <td>10</td> <td>8</td> <td>5</td> <td>4</td> <td>3</td> <td>3</td> <td>3</td> </tr> </table>	Working voltage(VDC)	6.3	10	16	25	35	50	63	100	Z-25°C / Z+20°C	5	4	3	2	2	2	2	2	Z-40°C / Z+20°C	12	10	8	5	4	3	3	3
	Working voltage(VDC)	6.3	10	16	25	35	50	63	100																			
Z-25°C / Z+20°C	5	4	3	2	2	2	2	2																				
Z-40°C / Z+20°C	12	10	8	5	4	3	3	3																				
Endurance	Test condition Duration time :2000 Hrs Ambient temperature :+85°C Applied voltage :Rated DC working voltage After test requirement at +20°C Capacitance change : ≤ ±20% of the initial measured value Dissipation factor : ≤200% of the initial specified value Leakage current : ≤The initial specified value																											
Shelf Life	Test condition Duration time :1000 Hrs Ambient temperature :+85°C Applied voltage :None After test requirement at +20°C :Same limits as Endurance. Pre-treatment for measurements shall be conducted after application of DC working voltage for 30 minutes.																											

For Audio Equipment

Multiplier for Ripple Current vs. Frequency

CAP(µ F)\Frequency(Hz)	50(60)	120	300	1K	10K
CAP ≤ 47	0.75	1.00	1.35	1.57	1.20
100 < CAP ≤ 470	0.80	1.00	1.23	1.34	1.50
1000 ≤ 33000	0.85	1.00	1.10	1.13	1.15

Diagram of Dimension:(unit:mm)

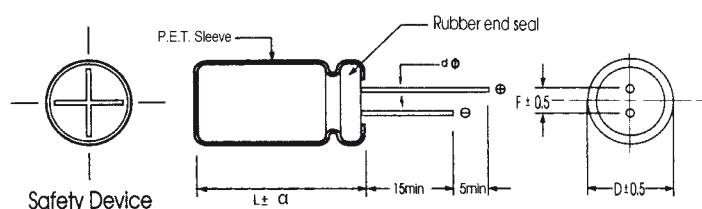

D φ	5	6.3	8	10	13	16	18	22
F	2.0	2.5	3.5	5.0	5.0	7.5	7.5	10
d φ	0.5		L < 20 0.5	L ≥ 20 0.6	0.6		0.8	

α	D < 18	D = 18		D > 18
	1.5	L < 35.5	L ≥ 35.5	2.0
		1.5	2.0	2.0

Case Size

φ D×L(mm)

Cap(μ F)	WV	6.3		10		16		25	
		Size	Ripple	Size	Ripple	Size	Ripple	Size	Ripple
47								5×11	117
100				5×11	162	5×11	155	6.3×11	187
220				6.3×11	247	6.3×11	265	8×11.5	325
330		6.3×11	282	6.3×11	300	8×11.5	365	10×12.5	415
470		6.3×11	330	6.3×11	355	8×11.5	445	10×12.5	535
1000		8×11.5	560	10×12.5	600	10×16	780	10×20	950
2200		10×20	1015	10×20	1075	13×20	1300	13×25	1550
3300		10×20	1245	13×20	1410	13×25	1700	16×25	1675
4700		13×20	1435	13×25	1800	16×25	2100	16×31.5	2380
6800		13×25	1600	16×25	2200	16×35.5	2520	18×35.5	2650
10000		16×25	2000	16×35.5	2450	18×35.5	2670	22×41	3000
15000		16×35.5	2620	18×35.5	2900	22×41	3400	22×51	3800
22000		18×41	3220	22×41	3700	22×51	4200		
33000		22×51	3900	22×51	4300				

Cap(μ F)	WV	35		50		63		100	
		Size	Ripple	Size	Ripple	Size	Ripple	Size	Ripple
0.1				5×11	2.1	5×11	1.5	5×11	2.1
0.22				5×11	2.7	5×11	3	5×11	4.7
0.33				5×11	4.2	5×11	5	5×11	7.5
0.47				5×11	6.0	5×11	7	5×11	11
1				5×11	12	5×11	15	5×11	21
2.2				5×11	24	5×11	28	5×11	31
3.3				5×11	35	5×11	35	5×11	40
4.7				5×11	41	5×11	45	5×11	46
10				5×11	65	5×11	70	6.3×11	75
22				5×11	97	5×11	107	6.3×11	125
33		5×11	107	5×11	120	6.3×11	137	8×11.5	165
47		5×11	125	6.3×11	150	6.3×11	172	10×12.5	220
100		6.3×11	205	8×11.5	255	10×12.5	300	10×20	370
220		10×12.5	370	10×12.5	417	10×16	485	13×25	615
330		10×12.5	475	10×16	580	10×20	670	13×25	755
470		10×16	630	13×20	770	13×20	880	16×25	1000
1000		13×20	1120	13×25	1320	16×25	1350	18×41	1500
2200		16×25	1650	16×35.5	2090	18×35.5	2220	22×51	2400
3300		16×35.5	2270	18×35.5	2430	22×41	2700		
4700		18×35.5	2540	22×41	2900	22×51	3400		
6800		22×41	3000	22×51	3500				

Ripple Current (mA, rms) at 85°C 120Hz

NR Series 85°C

Features

- ◆ Standard non polarity series for using in polarity reversal circuits.
- ◆ Design For audio equipment.
- ◆ RoHS Compliant

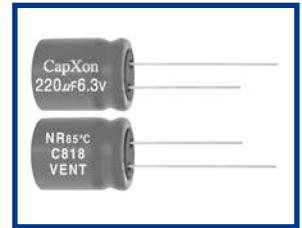

Specifications

Item	Performance Characteristics								
Operating Temperature Range	-40~+85°C								
Rated Voltage Range	6.3~100 VDC								
Capacitance Range	0.15 to 1000 µF								
Capacitance Tolerance	±20%(120Hz,+20°C)								
Leakage Current (+20°C,max.)	I ≤ 0.03 CV or 3 (µA) (After 1 minute with rated working voltage applied.)								
Dissipation Factor (tan δ , at 20°C , 120Hz)	Working Voltage(VDC)	6.3	10	16	25	35	50	63	100
	D.F.(%)max.	24	20	16	16	14	12	10	10
Low Temperature Characteristics (at 120Hz)	Impedance ratio max (at: 120Hz)								
	Working voltage(VDC)	6.3	10	16	25	35	50	63	100
	Z-25°C / Z+20°C	4	3	2	2	2	2	2	2
Endurance	Z-40°C / Z+20°C	8	6	4	4	3	3	3	3
	Test condition Duration time : 2000 Hrs Ambient temperature : +85°C Applied voltage : Rated DC working voltage Each 250 hours,we will reserve the terminal and test the characteristics After test requirement at +20°C Capacitance change : within ≤ ±20% of the initial measured value Dissipation factor : ≤ 200% of the initial specified value Leakage current : ≤ The initial specified value								
Shelf Life	Test condition Duration time : 1000 Hrs Ambient temperature : +85°C Applied voltage : None After test requirement at +20°C: Same limits as Endurance. Pre-treatment for measurements shall be conducted after application of DC working voltage for 30 minutes.								

For Audio Equipment

Multiplier for Ripple Current vs. Frequency

CAP(µF)\Frequency(Hz)	50(60)	120	400	1K	10K	50K-100K
CAP ≤ 10	0.8	1	1.30	1.45	1.65	1.70
10 < CAP ≤ 100	0.8	1	1.23	1.36	1.48	1.53
100 < CAP ≤ 1000	0.8	1	1.16	1.25	1.35	1.38
1000 < CAP	0.8	1	1.11	1.17	1.25	1.28

Diagram of Dimension:(unit:mm)

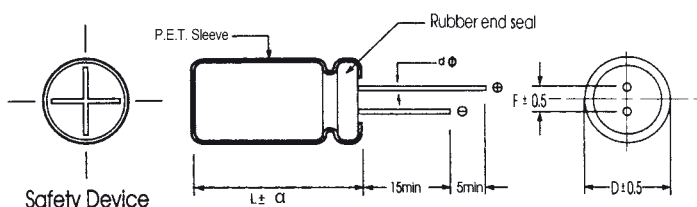

D φ	5	6.3	8	10	13	16
F	2.0	2.5	3.5	5.0	5.0	7.5
d φ	0.5			0.6		0.8

α	D < 18	D = 18		D > 18
		L < 35.5	L ≥ 35.5	
	1.5	1.5	2.0	2.0

Case Size

φ D×L(mm)

WV Cap(μF)	6.3V		10		16		25	
	Size	Ripple	Size	Ripple	Size	Ripple	Size	Ripple
4.7							5×11	26
10					5×11	43	5×11	44
22			5×11	60	6.3×11	71	6.3×11	71
33	5×11	62	6.3×11	70	6.3×11	90	8×11.5	110
47	6.3×11	76	6.3×11	95	8×11.5	122	10×12.5	150
100	8×11.5	154	10×12.5	188	10×12.5	208	10×16	250
220	10×12.5	245	10×16	294	10×20	360	13×25	478
330	10×16	330	10×20	360	13×20	480	13×25	615
470	10×20	360	13×20	538	13×25	638	16×25	720
1000	13×25	910	16×25	940	16×31.5	1090		

WV Cap(μF)	35		50		63		100	
	Size	Ripple	Size	Ripple	Size	Ripple	Size	Ripple
0.15							6.3×11	13
0.47			5×11	12	6.3×11	14	6.3×11	17
1			5×11	18	6.3×11	22	6.3×11	25
1.8			5×11	22	6.3×11	26	6.3×11	32
2.2			5×11	27	6.3×11	33	6.3×11	39
3.3			5×11	29	8×11.5	36	8×11.5	49
4.7	5×11	34	6.3×11	42	8×11.5	44	10×12.5	60
10	6.3×11	48	8×11.5	65	8×11.5	73	10×16	98
22	8×11.5	96	10×12.5	118	10×12.5	125	10×20	165
33	10×12.5	135	10×16	155	10×16	170	13×20	275
47	10×12.5	154	10×20	200	10×20	215		
100	10×20	275	13×25	370	13×25	384		
220	13×25	560	16×25	645				
330	16×25	670	16×31.5	760				

Ripple Current (mA, rms) at 85°C 120Hz

LR Series Snap-in Type 85°C

Features

- ◆ Snap-in design for audio equipment.
- ◆ Aluminum case designed explosion-proof vent. Non solvent-proof type
- ◆ RoHS Compliant



Specifications

Item	Performance Characteristics																					
Operating Temperature Range	-40~+85°C																					
Rated voltage Range	16 to 100 VDC																					
Capacitance Range	680~33000 µ F																					
Capacitance Tolerance	±20%(120Hz,+20°C)																					
Leakage Current (+20°C,max.)	$I \leq 0.02 CV (\mu A)$ After 5 minute with rated working voltage applied.																					
Dissipation Factor ($\tan \delta$, at 20°C , 120Hz)	<table border="1"> <tr> <td>Working Voltage(VDC)</td> <td>16</td> <td>25</td> <td>35</td> <td>50</td> <td>63</td> <td>80</td> <td>100</td> </tr> <tr> <td>D.F.(%)max.</td> <td>35</td> <td>30</td> <td>30</td> <td>30</td> <td>22</td> <td>20</td> <td>20</td> </tr> </table>	Working Voltage(VDC)	16	25	35	50	63	80	100	D.F.(%)max.	35	30	30	30	22	20	20					
	Working Voltage(VDC)	16	25	35	50	63	80	100														
D.F.(%)max.	35	30	30	30	22	20	20															
For capacitance > 22000 µ F, add 2% per another 1000 µ F.																						
Low Temperature Characteristics (at 120Hz)	Impedance ratio max																					
	<table border="1"> <tr> <td>Rated voltage(V)</td> <td>16</td> <td>25</td> <td>35</td> <td>50</td> <td>63</td> <td>100</td> </tr> <tr> <td>Z - 25°C / Z+20°C</td> <td>5</td> <td>4</td> <td>4</td> <td>4</td> <td>4</td> <td>4</td> </tr> <tr> <td>Z - 40°C / Z+20°C</td> <td>15</td> <td>15</td> <td>12</td> <td>12</td> <td>12</td> <td>12</td> </tr> </table>	Rated voltage(V)	16	25	35	50	63	100	Z - 25°C / Z+20°C	5	4	4	4	4	4	Z - 40°C / Z+20°C	15	15	12	12	12	12
	Rated voltage(V)	16	25	35	50	63	100															
Z - 25°C / Z+20°C	5	4	4	4	4	4																
Z - 40°C / Z+20°C	15	15	12	12	12	12																
Endurance	Test condition Duration time :2000 Hrs Ambient temperature :+85°C Applied voltage :Rated DC working voltage After test requirement at +20°C Capacitance change : $\leq \pm 25\%$ of the initial measured value Dissipation factor : $\leq 200\%$ of the initial specified value Leakage current : \leq The initial specified value																					
Shelf Life	Test condition Duration time :1000 Hrs Ambient temperature :+85°C Applied voltage :None After test requirement at +20°C: Same limits as Endurance. Pre-treatment for measurements shall be conducted after application of DC working voltage for 30 minutes.																					

For Audio Equipment

Multiplier for Ripple Current vs. Frequency

CAP(µ F)\ Frequency(Hz)	50(60)	120	1K	10K	100K
CAP ≤ 100	0.80	1	1.36	1.48	1.53
100 < CAP ≤ 1000	0.80	1	1.25	1.35	1.38
1000 < CAP	0.80	1	1.17	1.25	1.28

Diagram of Dimensions:(unit:mm)

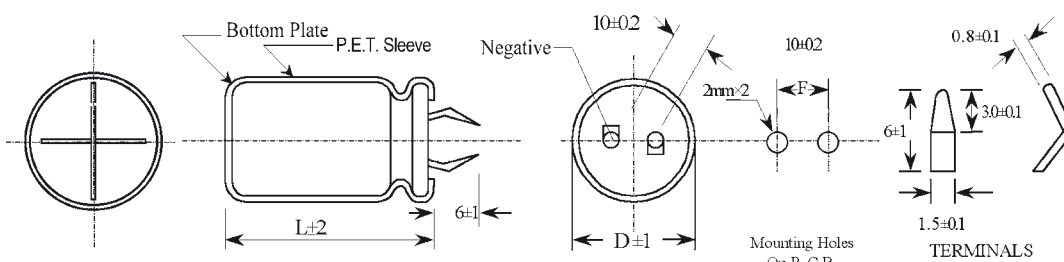

Safety Device

Case Size

φ D x L (mm)

WV φ D Cap (μF)	16								25							
	22		25		30		35		22		25		30		35	
	Size	Ripple	Size	Ripple	Size	Ripple	Size	Ripple	Size	Ripple	Size	Ripple	Size	Ripple	Size	Ripple
820									22×21	0.75						
1000											25×21	0.95				
1200	22×21	0.95														
1500			25×21	1.10										30×21	1.30	
1800	22×26	1.20									25×26	1.55				
2200					30×21	1.35			22×36	1.85	25×21	1.50	30×26	1.80	35×22	1.75
											25×31	1.80				
2700			25×26	1.75					22×26	1.70						
									22×46	2.20	25×36	2.15				
3300	22×21	1.50	25×31	2.00			35×22	1.95	22×21	1.50			30×21	1.85		
									22×31	1.80			30×31	2.40		
									22×51	2.50	25×41	2.45			35×27	2.45
3900	22×46	2.30	25×21	1.55							25×21	1.55				
			25×36	2.35	30×26	2.35					25×26	1.10				
											25×46	2.80	30×36	2.80		
4700	22×21	1.35	25×41	2.70					22×26	1.70					35×22	2.20
	22×26	1.75					35×27	2.60	22×36	2.30	25×31	2.25			35×32	3.15
	22×51	2.75			30×31	2.70							30×41	3.25		
5600			25×46	2.90	30×21	1.85			22×41	2.50	25×36	2.40	30×21	1.85		
													30×26	2.50	35×36	3.50
					30×36	2.90							30×46	3.50		
6800	22×31	2.20	25×21	1.70			35×32	3.15	22×31	2.20	25×26	2.15				
			25×26	2.15					22×51	2.65	25×41	2.65	30×31	2.65		
			25×51	3.20	30×41	3.20									35×42	3.80
8200							35×22	2.25	22×36	2.35	25×31	2.30			35×22	2.25
	22×26	1.90	25×31	2.30			35×37	3.30			25×46	2.90	30×36	2.85	35×27	3.05
	22×36	2.40			30×46	3.35									35×47	4.00
10000	22×31	2.05			30×21	2.10	35×42	3.50	22×41	2.65	25×36	2.50	30×26	2.65		
			25×26	2.00	30×26	2.50					25×51	3.30	30×41	3.30	35×32	3.30
	22×41	2.65	25×36	2.45												
12000	22×36	2.20	25×31	2.15	30×31	2.72	35×22	2.10	22×46	2.90	25×41	2.75	30×31	2.80	35×27	2.65
	22×51	2.75	25×41	2.75			35×42	3.50					30×46	3.55	35×37	3.50
							35×47	3.70								
15000	20×41	2.50	25×36	2.40	30×26	2.50					25×46	3.15	30×36	3.10		
			25×46	3.10	30×36	3.10							30×51	4.15	35×42	4.00
18000	22×46	2.80	25×41	2.60	30×31	2.65	35×32	3.45			25×51	3.55	30×41	3.40	35×32	3.50
			25×51	3.50	30×41	3.40									35×47	4.45
22000			25×46	2.95	30×36	2.90	35×27	2.90					30×46	3.85	35×37	3.85
					30×46	3.80	35×37	3.80								
27000			25×51	3.40	30×41	3.25										
					30×51	4.25	35×32	3.35							35×42	4.30
33000							35×42	4.25								
					30×46	3.70	35×37	3.65							35×47	4.85
							35×47	4.50								

Ripple Current (A, rms) at 85°C 120Hz

φ DxL (mm)

Cap (μF)	35								50							
	22		25		30		35		22		25		30		35	
	Size	Ripple	Size	Ripple	Size	Ripple	Size	Ripple	Size	Ripple	Size	Ripple	Size	Ripple	Size	Ripple
680									22×26	1.00						
820			25×21	0.85					22×21	1.00						
									22×31	1.25	25×21	1.35				
1000	22×26	1.00									25×21	1.50				
1200	22×21	1.30	25×26	1.40												
	22×31	1.45			30×21	1.40										
1500	22×36	1.55	25×31	1.55					22×21	1.55	25×36	2.15	30×21	1.80		
									22×31	1.80			30×26	2.15		
									22×46	2.20						
1800	22×26	1.55	25×21	1.65	30×26	1.75	35×22	1.70	22×51	2.45	25×21	1.65			35×27	2.40
	22×41	1.45									25×26	2.15				
											25×41	2.45				
2200	22×46	1.95	25×36	1.95	30×31	1.95			22×26	1.85	25×31	2.30	30×36	2.60	35×22	2.60
									22×36	2.35	25×51	2.65			35×32	2.60
2700	22×31	2.05	25×26	2.00	30×21	2.05	35×27	2.30	22×46	2.45			30×26	2.60		
			25×46	2.35	30×36	2.30					25×36	2.50	30×46	3.00	35×37	2.95
3300	22×26	1.75	25×31	2.20			35×32	2.65	22×36	2.20			30×31	2.80		
	22×36	2.25	25×51	2.70	30×41	2.70			22×51	2.80	25×41	2.80	30×51	3.30	35×42	3.25
3900	22×41	2.40	25×36	2.30	30×21	1.85	35×22	2.50							35×22	2.45
					30×26	2.40	35×37	3.00	22×41	2.45	25×31	2.50	30×26	2.35	35×27	3.15
					30×46	3.00					25×46	3.00	30×36	3.00	35×47	3.50
4700	22×31	2.20	25×26	2.15	30×31	2.55	35×42	3.55	22×46	2.60	25×36	2.70	30×41	3.30	35×32	3.35
	22×46	2.70			30×51	3.55					25×51	3.40			35×52	3.90
5600	22×36	2.35	25×31	2.25			35×22	2.25	22×51	2.90			30×31	3.00	35×22	2.85
	22×41	3.00	25×41	3.00			35×27	2.85			25×41	2.90	30×46	3.60	35×37	3.60
	22×51	2.60					35×47	3.80								
6800					30×26	2.60					25×41	3.30	30×36	3.25		
					30×36	3.30	35×32	3.05					30×51	4.10	35×42	3.95
							35×52	4.15								
8200	22×46	2.90	25×41	2.70	30×31	2.75							30×41	3.55	35×32	3.65
					30×41	3.60	35×37	3.30							35×47	4.40
10000			25×46	3.05	30×36	3.00							30×46	4.00	35×37	4.00
					30×51	3.80	35×27	3.20							35×52	5.50
							35×42	3.70								
12000			25×51	3.45	25×51	3.30	35×32	3.40								
							35×37	4.10							35×42	4.35
							35×47	3.80								
15000					30×46	3.80	35×52	4.80							35×52	4.70
18000					30×51	4.30	35×42	4.15								
22000							35×47	4.70								

For Audio Equipment

Ripple Current (A, rms) at 85°C 120Hz

φ DxL(mm)

WV φ D Cap(μF)	63								80							
	22		25		30		35		22		25		30		35	
	Size	Ripple	Size	Ripple	Size	Ripple	Size	Ripple	Size	Ripple	Size	Ripple	Size	Ripple	Size	Ripple
680	22×26	1.75							22×36	2.25	25×31	2.15				
820	22×21	1.30	25×21	1.65	30×21	1.90			22×31	2.05	25×21	1.65	30×21	2.05	35×22	2.55
	22×31	1.90	25×26	1.85					22×41	2.45	25×26	2.00	30×26	2.40		
1000											25×36	2.35				
	22×26	1.85							22×26	1.85			30×31	2.60	35×22	2.10
	22×36	2.05	25×31	2.00					22×36	2.20	25×31	2.15				
1200									22×51	2.60	25×41	2.60				
	22×31	1.95	25×21	1.65	30×21	1.95			22×31	1.95	25×26	1.90	30×21	2.00	35×27	2.95
	22×41	2.25	25×26	1.90	30×26	2.20	35×22	2.30	22×41	2.45	25×36	2.30	30×26	2.40		
1500											25×46	2.85	30×36	2.80		
	22×26	1.90							22×36	2.15	25×31	2.10				
	22×36	2.15	25×31	2.10					22×51	2.60	25×41	2.65	30×31	2.65	35×32	3.25
1800											25×51	3.30	30×41	3.20		
	22×31	2.00	25×26	2.00	30×21	2.05	35×22	2.45	22×41	2.35			30×26	2.40	35×22	2.50
	22×41	2.35	25×41	2.90	30×26	2.35	35×27	2.70	22×46	2.70	25×46	2.85	30×36	2.85	35×27	3.00
2200													30×46	3.55	35×37	3.50
	22×51	2.90			30×31	2.90										
	22×36	2.20	25×31	2.15			35×22	2.10			25×36	2.75	30×31	2.55		
2700											25×51	3.25	30×41	3.15	35×32	3.25
	22×46	2.70	25×36	2.75	30×31	2.50							30×51	4.05	35×42	3.90
			25×46	3.25	30×36	3.20										
3300	22×41	2.45	25×36	2.35	30×26	2.50	35×27	2.95					30×36	2.80	35×27	3.00
			25×46	2.80	30×36	2.75	35×32	3.65					30×46	3.60	35×37	3.55
					30×46	3.30									35×47	4.45
3900	22×46	2.80	25×41	2.60	30×31	2.70	35×32	3.15			25×51	3.25	30×41	3.15	35×32	3.20
			25×51	3.20	30×41	3.20	35×37	4.00					30×51	4.10	35×42	3.95
					30×51	3.80									35×52	5.05
4700			25×46	2.85	30×36	2.85							30×46	3.45	35×37	3.40
					30×46	3.35	35×37	3.35							35×47	4.35
							35×42	4.30								
5600							35×32	3.20					30×46	3.85	35×42	3.75
			25×51	3.20	30×41	3.10									35×52	4.85
					30×51	3.80	35×52	4.50								
6800															35×47	4.10
					30×46	3.45	35×37	3.40								
8200							35×42	4.35								
					30×51	3.90	35×42	3.75							35×52	4.65
10000							35×52	4.60								
							35×47	4.20								
							35×52	4.80								

Ripple Current (A, rms) at 85°C 120Hz

φ DxL(mm)

Cap(μF)	wv	100							
		22		25		30		35	
		Size	Ripple	Size	Ripple	Size	Ripple	Size	Ripple
680	φ D	22×26	1.75						
		22×36	2.15	25×31	2.10				
		22×46	2.65	25×36	2.70				
820	φ D	22×31	1.85	25×26	1.80	30×21	1.90		
		22×41	2.40			30×26	2.35	35×22	2.45
		22×51	3.00	25×41	3.00			35×27	2.85
1000	φ D	22×46	2.70	25×36	2.35	30×31	3.00		
				25×41	3.10	30×36	3.30	35×32	3.05
				25×51	2.35				
1200	φ D	22×41	2.20	25×31	2.75	30×26	2.20	35×22	2.30
		22×51	3.00			30×31	3.05	35×27	2.90
						30×41	3.60	35×37	3.30
1500	φ D	22×46	2.55	25×36	3.60	30×36	3.40	35×32	3.40
				25×51	3.20	30×51	3.90	35×42	3.95
1800	φ D	22×51	2.85	25×41	2.85	30×31	2.90	35×27	2.75
						30×41	3.70	35×37	3.40
								35×47	4.15
2200	φ D			25×46	3.20	30×36	3.20	35×32	3.00
						30×51	3.95	35×42	3.80
								35×52	4.75
2700	φ D					30×41	3.55	35×37	3.25
								35×47	4.30
3300	φ D					30×51	3.75	35×52	4.95
3900	φ D							35×42	4.30
4700	φ D							35×52	4.50

Ripple Current (A, rms) at 85°C 120Hz

For Audio Equipment

LP Series Snap-in Type 85°C

Features

- ◆ Directly mountable on printed circuit board, without holders.
- ◆ Aluminum case designed explosion-proof vent.
- ◆ RoHS Compliant



Specifications

Item	Performance Characteristics										
Operating Temperature Range	-40 to +85°C	-25 to +85°C									
Rated Voltage Range	10 to 100 VDC	160 to 450 VDC									
Capacitance Range	470 to 68000 µF	47 to 2700 µF									
Capacitance Tolerance	±20% (120Hz, +20°C)										
Leakage Current (+20°C, max.)	I ≤ 0.02CV After 5 minutes with rated working voltage applied.										
Dissipation Factor (tan δ, at 20°C, 120Hz)	Less than the value under table (%)										
	µF \ VDC	10~16	25~35	50~63	80~100	160~250	315~450				
	47~390	—	—	—	—	15	20				
	470~3900	25	20	20	20	15	20				
	4700~8200	35	30	30	25	—	—				
	10000~22000	40	35	30	—	—	—				
	27000~47000	45	40	35	—	—	—				
Low Temperature Characteristics (at 120Hz)	Impedance ratio max.										
	Rated voltage(V)	10	16	25	35	50	63	100	160	200~250	400~450
	Z - 25°C / Z+20°C	5	5	4	4	4	4	4	4	4	8
	Z - 40°C / Z+20°C	15	15	15	12	12	12	12	—	—	—
Endurance	Test conditions										
	Duration time	:2000 Hrs									
	Ambient temperature	:+85°C									
	Applied voltage	:Rated DC working voltage									
	After test requirement at +20°C										
	Capacitance change	:≤ ±20% of the initial measured value									
Dissipation factor	:≤ 200% of the initial specified value										
Leakage current	:≤ The initial specified value										
Shelf Life	Test conditions										
	Duration time	:1000 Hrs									
	Ambient temperature	:+85°C									
	Applied voltage	:None									
	After test requirement at +20°C : Same limits as Endurance.										
	Pre-treatment for measurements shall be conducted after application of DC working voltage for 30 minutes.										

Multiplier for Ripple Current vs. Frequency

CAP(µF) \ Frequency(Hz)	50(60)	120	1K	10K	50K-100K
10 < CAP ≤ 100	0.8	1	1.36	1.48	1.53
100 < CAP ≤ 1000	0.8	1	1.25	1.35	1.38
1000 < CAP	0.8	1	1.17	1.25	1.28

Diagram of Dimensions:(unit:mm)

SYMBOL G : P.C.B. TERMINAL (SNAP-IN)

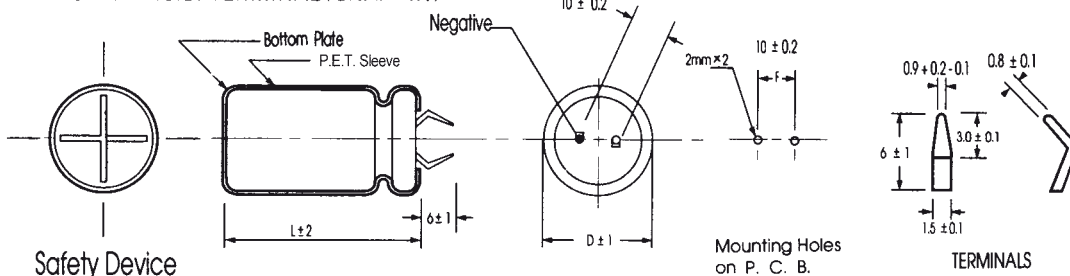

Case Size

WV Cap (μF) / φ D		10								16							
		22		25		30		35		22		25		30		35	
		Size	Ripple	Size	Ripple	Size	Ripple	Size	Ripple	Size	Ripple	Size	Ripple	Size	Ripple	Size	Ripple
4700	22x21	2.40								22x21	2.40						
6800	22x26	2.84								22x26	2.84						
8200	22x26	2.90								22x26	2.90						
10000	22x31	3.06	25x26	3.06						22x31	3.06	25x26	3.06				
12000	22x31	3.43	25x26	3.43						22x31	3.43	25x26	3.43				
15000	22x36	3.94	25x31	3.94						22x36	3.94	25x31	3.94				
18000	22x41	4.34	25x31	4.34						22x41	4.34	25x31	4.34				
22000	22x46	4.80	25x36	4.80	30x31	4.80				22x46	4.80	25x36	4.80	30x31	4.80		
27000			25x46	7.57	30x36	7.57						25x46	7.57	30x36	7.57		
33000			25x51	8.20	30x41	8.20	35x32	8.20				25x51	8.20	30x41	8.20	35x32	8.20
39000					30x46	8.33	35x37	8.33						30x46	8.33	35x37	8.33
47000					30x51	8.96	35x42	8.93						30x51	8.96	35x42	8.96
56000							35x47	10.5						30x56	10.5	35x52	10.8
68000							35x52	10.8									

WV Cap (μF) / φ D		25								35							
		22		25		30		35		22		25		30		35	
		Size	Ripple	Size	Ripple	Size	Ripple	Size	Ripple	Size	Ripple	Size	Ripple	Size	Ripple	Size	Ripple
2200										22x21	2.00						
										22x26	2.18						
3300										22x26	2.46						
										22x26	2.50						
3900										22x31	2.64						
										22x31	2.68	25x26	2.68				
4700	22x26	2.64								22x31	2.72	25x26	2.72				
	22x26	2.72								22x31	2.78						
5600	22x31	2.78															
6800	22x31	2.93	25x26	2.93						22x36	3.06	25x31	3.06				
8200	22x31	3.05	25x26	3.05						22x41	3.29	25x36	3.34				
10000	22x36	3.43	25x31	3.43	30x26	3.43				22x46	3.60	25x41	3.60	30x31	3.60		
12000	22x41	3.84	25x36	3.84	30x31	3.84				22x51	3.80	25x46	3.80	30x36	3.80	35x32	3.80
15000	22x51	4.39	25x41	4.39	30x31	4.39						25x51	3.92	30x41	3.92	35x32	3.92
18000			25x46	4.80	30x36	4.80								30x46	4.70	35x37	4.70
22000			25x51	5.40	30x41	5.40								30x51	5.45	35x42	5.45
27000					30x46	5.97	35x37	5.97								35x47	5.78
33000					30x51	6.24	35x42	6.24								35x52	6.36
39000							35x47	7.10									
47000							35x52	7.60									

WV Cap (μF) / φ D		50								63							
		22		25		30		35		22		25		30		35	
		Size	Ripple	Size	Ripple	Size	Ripple	Size	Ripple	Size	Ripple	Size	Ripple	Size	Ripple	Size	Ripple
1000										22x21	1.50						
										22x26	1.58						
1500	22x26	1.44								22x26	1.68						
2200	22x26	2.04								22x31	2.52	25x26	2.52				
2700	22x31	2.30								22x36	2.82	25x31	2.82				
3300	22x31	2.64	25x26	2.64						22x41	3.12	25x31	3.12	30x26	3.12		
3900	22x31	2.72	25x26	2.72						22x46	3.21	25x36	3.21	30x31	3.21		
4700	22x36	2.88	25x31	2.88	30x26	2.88				22x51	3.28	25x41	3.28			35x27	3.28
5600	22x41	3.06	25x36	3.06	30x31	3.06						25x46	3.86	30x36	3.86	35x32	3.86
6800	22x51	3.24	25x41	3.24	30x31	3.24						25x51	4.32	30x41	4.32	35x32	4.32
8200			25x46	3.48	30x36	3.48								30x46	4.44	35x37	4.44
10000			25x51	3.96	30x41	3.96	35x32	3.96								35x47	4.77
12000					30x46	4.10	35x37	4.10									
15000					30x51	4.70	35x42	4.70								35x63	5.04
18000							35x47	5.31									
22000							35x52	5.85									

Ripple Current (A, rms) at 85°C 120Hz

φ DxL(mm)

WV Cap (μF) φ D	80								100								
	22		25		30		35		22		25		30		35		
	Size	Ripple	Size	Ripple	Size	Ripple	Size	Ripple	Size	Ripple	Size	Ripple	Size	Ripple	Size	Ripple	
470										22x21	1.34						
680	22x21	1.25															
	22x26	1.34								22x26	1.53						
1000	22x26	1.62								22x31	1.62	25x26	1.62				
	22x31	1.65								22x31	1.65	25x31	1.74				
1200										22x36	1.74						
										22x36	1.72	25x36	1.85	30x31	1.85		
1500	22x31	1.76	25x26	1.76						22x41	1.85						
										22x41	2.05	25x41	2.20	30x31	2.20		
1800	22x36	1.82	25x31	1.82						22x46	2.20						
										22x46	2.52	25x41	2.64	30x31	2.64		
2200	22x41	2.52	25x31	2.52	30x26	2.52				22x51	2.64						
										22x51	3.08	25x46	3.16	30x36	3.16		
2700	22x46	2.76	25x36	2.76	30x31	2.76						25x51	3.42	30x41	3.42		
3300	22x51	3.24	25x41	3.24	30x31	3.24											
3900			25x46	3.40	30x36	3.40								30x46	3.58	35x37	3.58
4700			25x51	3.60	30x41	3.60								30x51	3.72	35x42	3.72
5600					30x46	3.78	35x37	3.78								35x47	3.78
6800					30x51	4.60	35x42	4.60								35x52	4.1
8200							35x52	4.92									
10000							35x63	5.04									

WV Cap (μF) φ D	160								200								
	22		25		30		35		22		25		30		35		
	Size	Ripple	Size	Ripple	Size	Ripple	Size	Ripple	Size	Ripple	Size	Ripple	Size	Ripple	Size	Ripple	
150										22x21	0.96						
180										22x21	0.98						
										22x26	1						
220	22x21	1.16								22x26	1.36						
	22x26	1.2															
270	22x26	1.35								22x26	1.46						
										22x31	1.5						
330	22x36	1.39								22x31	1.89	25x26	1.89				
	22x31	1.44															
390	22x31	1.66	25x26	1.66						22x31	1.92	25x31	1.92				
	22x31	1.7	25x31	1.76						22x31	2.09						
470	22x36	1.76								22x36	2.23	25x31	2.23	30x26	2.23		
	22x36	2.03	25x31	2.03	30x26	2.03				22x41	2.57	25x36	2.57	30x26	2.57		
560										22x46	2.57	25x41	2.57				
										22x46	2.98	25x31	2.98	30x31	2.98		
680	22x41	2.36	25x36	2.36	30x31	2.36						25x36	2.98				
820	22x46	2.72	25x41	2.72	30x31	2.57				22x51	3.26	25x46	3.26	30x36	3.26	35x27	3.26
					30x36	2.72											
1000			25x46	3.13								25x46	3.74				
					30x41	3.13	35x32	3.13				25x51	3.92	30x41	3.92	35x32	3.92
1200			25x51	3.44	30x36	3.44	35x32	3.25						30x46	4.25	35x37	4.25
							35x37	3.44									
1500					30x46	3.96	35x37	3.96						30x51	4.99	35x42	4.99
1800					30x51	4.47	35x42	4.47								35x47	5.84
2200							35x47	4.65								35x52	6.07
2700							35x52	4.76									

WV Cap (μF) φ D	220								250								
	22		25		30		35		22		25		30		35		
	Size	Ripple	Size	Ripple	Size	Ripple	Size	Ripple	Size	Ripple	Size	Ripple	Size	Ripple	Size	Ripple	
120										22x21	0.85						
150										22x21	0.9						
										22x26	0.98						
180	22x21	0.75								22x26	1.05						
	22x26	0.87								22x31	1.12						
220	22x26	0.95								22x26	1.26						
	22x26	1.1								22x31	1.36	25x26	1.36				
270	22x31	1.22								22x31	1.6	25x31	1.72				
	22x31	1.3	25x26	1.3													
330	22x31	1.55								22x31	1.75	25x26	1.74				
			25x26	1.55						22x36	1.87	25x31	1.87	30x26	1.87		
390	22x31	1.57								22x41	2.04	25x36	2.04	30x31	2.04		
	22x36	1.65	25x31	1.65													
470	22x36	1.75								22x46	2.38	25x41	2.38	30x31	2.38		
	22x41	1.85	25x36	1.85	30x26	1.85											
560	22x41	2.1	25x36	2.1						22x51	2.74	25x46	2.81	30x36	2.81	35x27	2.81
	22x46	2.2	25x41	2.2	30x31	2.2	35x27	2.2									
680	22x46	2.25	25x41	2.25								25x51	3.11	30x41	3.11	35x32	3.11
	22x51	2.3	25x46	2.3	30x36	2.3	35x27	2.3									
820	22x51	2.54	25x46	2.54	30x41	2.6	35x32	2.6						30x46	3.55	35x37	3.55
			25x51	2.6													
1000			25x51	3.07										30x51	4	35x42	4
			25x56	3.2	30x46	3.2	35x37	3.2									
1200					30x51	3.7	35x42	3.7								35x47	4.55
1500					30x56	3.85	35x47	3.85								35x52	5.34
1800							35x52	4									
2200							35x57	4.2									

φ DxL(mm)

Cap (μF)	φ D	WV																				
		350										400										
		22		25		30		35		40		22		25		30		35		40		
		Size	Ripple	Size	Ripple	Size	Ripple	Size	Ripple	Size	Ripple	Size	Ripple	Size	Ripple	Size	Ripple	Size	Ripple	Size	Ripple	
47												22x21	0.42									
56																						
68												22x26	0.47									
82												22x31	0.51									
100												22x26	0.83									
100		22x26	0.76									22x31	1.03	25x26	1.03							
120		22x31	0.89	25x26	0.89							22x31	1.07	25x26	1.07							
150		22x36	1.08	25x31	1.08							22x36	1.26	25x31	1.26	30x26	1.26					
180		22x41	1.15	25x36	1.15	30x26	1.15					22x41	1.46	25x36	1.46	30x26	1.46					
220																30x31	1.46					
220		22x46	1.4	25x41	1.4	30x31	1.4	35x27	1.4			22x41	1.59									
270				25x46	1.63	30x36	1.63	35x27	1.75			22x51	1.75	25x41	1.75	30x36	1.75					
330				25x51	1.88	30x41	1.88	35x32	1.88					25x46	1.96	30x36	1.96	35x32	1.96			
390						30x46	2.12	35x37	2.12					25x51	2.26	30x41	2.26	35x37	2.26			
470						30x51	2.41	35x42	2.41							30x46	2.5	35x42	2.5			
560																30x46	2.54	35x42	2.67	40x37	2.8	
560																30x51	2.66	35x47	2.8			
560																		35x42	2.89			
560																		35x47	3.03			
680								35x47	2.9									35x52	3.16	40x46	3.2	
680								35x52	3.2									35x47	3.27	40x52	3.69	
820																		35x52	3.41			
820																		35x63	3.80			

Cap (μF)	φ D	WV																				
		420										450										
		22		25		30		35		40		22		25		30		35		40		
		Size	Ripple	Size	Ripple	Size	Ripple	Size	Ripple	Size	Ripple	Size	Ripple	Size	Ripple	Size	Ripple	Size	Ripple	Size	Ripple	
47		22x21	0.38									22x26	0.36									
56		22x26	0.42																			
68		22x31	0.49									22x26	0.46									
82		22x26	0.79									22x31	0.5									
100		22x31	0.85	25x26	0.85							22x31	0.89	25x26	0.89							
100		22x36	1.03	25x26	1.03							22x36	1.03	25x31	1.03							
120		22x36	1.12	25x31	1.12							22x41	1.19	25x36	1.19							
150		22x36	1.25																			
150		22x41	1.32	25x36	1.32	30x31	1.32					22x51	1.39	25x41	1.39	30x31	1.39					
180														25x36	1.37							
180														25x41	1.45							
180		22x41	1.38	25x41	1.48	30x36	1.48					22x51	1.52	25x46	1.52	30x36	1.52					
220														25x41	1.6							
220		22x46	1.63	25x46	1.75	30x41	1.75	35x32	1.75					25x46	1.68	30x31	1.68					
270				25x51	1.98	30x46	1.98	35x37	1.98			22x46	1.76	25x51	1.76	30x41	1.76	35x37	1.76			
330				25x51	2.27			35x42	2.27							30x46	2	35x37	2			
390								35x47	2.52	40x32	2.52					30x46	2.29	35x37	2.29			
470																		35x42	2.54	40x37	2.54	
470																		35x42	2.76			
560										40x37	2.91							35x47	2.89	40x42	2.89	
560										40x42	2.95									40x52	3.26	
680										40x52	3.3											

Ripple Current (A, rms) at 85°C 120Hz

LS Series Snap-in Type 85°C Miniaturized

Features

- ◆ Directly mountable on printed circuit board, without holders.
- ◆ Aluminum case designed explosion-proof vent.
- ◆ RoHS Compliant



Specifications

Item	Performance Characteristics									
Operating Temperature Range	-25 to +85°C									
Rated Voltage Range	160 to 450 VDC									
Capacitance Range	47 to 2700 µF									
Capacitance Tolerance	±20% (120Hz, +20°C)									
Leakage Current (+20°C, max.)	I ≤ 0.02CV After 5 minutes with rated working voltage applied.									
Dissipation Factor (tan δ · at 20°C · 120Hz)	Less than the value under table (%)									
	<table border="1"> <thead> <tr> <th>µF \ VDC</th> <th>160~250</th> <th>315~450</th> </tr> </thead> <tbody> <tr> <td>47~390</td> <td>15</td> <td>20</td> </tr> <tr> <td>470~2700</td> <td>15</td> <td>20</td> </tr> </tbody> </table>	µF \ VDC	160~250	315~450	47~390	15	20	470~2700	15	20
	µF \ VDC	160~250	315~450							
47~390	15	20								
470~2700	15	20								
Low Temperature Characteristics (at 120Hz)	Impedance ratio max									
	<table border="1"> <thead> <tr> <th>Working voltage (VDC)</th> <th>160</th> <th>200~250</th> <th>400~450</th> </tr> </thead> <tbody> <tr> <td>Z -25°C / Z +20°C</td> <td>4</td> <td>4</td> <td>8</td> </tr> </tbody> </table>	Working voltage (VDC)	160	200~250	400~450	Z -25°C / Z +20°C	4	4	8	
Working voltage (VDC)	160	200~250	400~450							
Z -25°C / Z +20°C	4	4	8							
Endurance	Test conditions Duration time :2000 Hrs Ambient temperature :+85°C Applied voltage :Rated DC working voltage After test requirement at +20°C Capacitance change :≤ ±20% of the initial measured value Dissipation factor :≤ 200% of the initial specified value Leakage current :≤ The initial specified value									
Shelf Life	Test conditions Duration time :1000 Hrs Ambient temperature :+85°C Applied voltage :None After test requirement at +20°C : Same limits as Endurance. Pre-treatment for measurements shall be conducted after application of DC working voltage for 30 minutes.									

Multiplier for Ripple Current vs. Frequency

CAP(µF) \ Frequency(Hz)	50(60)	120	1K	10K	50K-100K
10 < CAP ≤ 100	0.8	1	1.36	1.48	1.53
100 < CAP ≤ 1000	0.8	1	1.25	1.35	1.38
1000 < CAP	0.8	1	1.17	1.25	1.28

Diagram of Dimensions:(unit:mm)

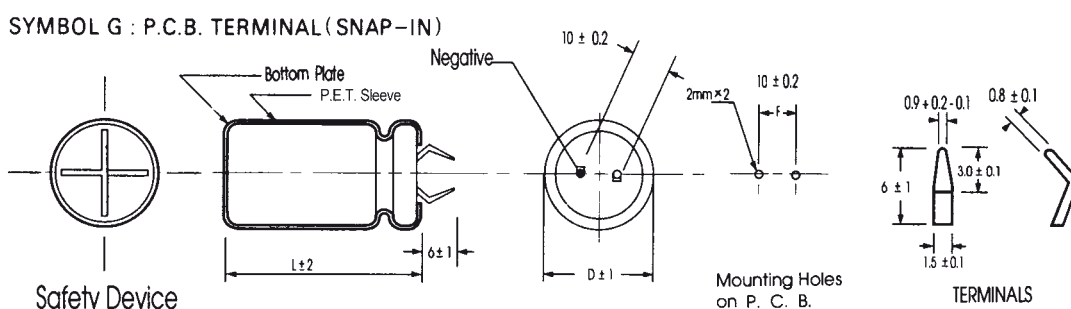

Case Size

φ DxL(mm)

Cap (μF)	φ D	WV		160								200							
		22		25		30		35		22		25		30		35			
		Size	Ripple	Size	Ripple	Size	Ripple	Size	Ripple	Size	Ripple	Size	Ripple	Size	Ripple	Size	Ripple		
150										22X21	0.96								
180		22X21	1.12							22X21	1.00								
220		22X21	1.35							22X21	1.36								
270		22X21	1.40							22X26	1.50								
330		22X26	1.44							22X26	1.70	25X26	1.70						
390		22X26	1.66	25X21	1.66					22X26	1.80	25X26	1.80						
470		22X31	1.76	25X26	1.76	30X21	1.76			22X31	2.23	25X26	2.23	30X21	2.23				
560		22X31	2.03	25X26	2.03	30X26	2.03	35X27	3.13	22X36	2.40	25X31	2.40	30X26	2.40				
						30X21	1.87												
680		22X36	2.36	25X31	2.36	30X26	2.36	35X32	3.44	22X41	2.55	25X36	2.55	30x26	2.55	35x32	3.52		
								35X27	3.20										35X27
820		22X41	2.27	25X36	2.27	30X31	2.27	35X32	3.96			25X36	3.00	30x31	3.00	35x32	3.80		
						30X26	2.10	35X27	2.10	22X46	2.80							35X27	3.50
1000				25X41	3.13	30X31	3.13	35X32	4.47					25X46	3.52	30x36	3.52	35x37	4.40
		22X51	2.50	25X36	2.95			35X27										35x32	4.10
1200				25X46	3.44	30X36	3.44	35X37	4.65					30x41	3.80	35x42	5.00		
									35X32	4.10									35x37
1500						30X41	3.96	35X42	4.76					30x46	4.40	35x47	5.40		
								35x37	4.30									35x42	5.10
1800						30X46	4.47	35x47	4.60					30X56	5.15	35X52	5.15		
2200						30X56	4.60	35X52	4.60							35X57	5.21		

Cap (μF)	φ D	WV		220								250							
		22		25		30		35		22		25		30		35			
		Size	Ripple	Size	Ripple	Size	Ripple	Size	Ripple	Size	Ripple	Size	Ripple	Size	Ripple	Size	Ripple		
120										22X21	0.85								
150		22X21	0.71							22X21	0.95								
180		22X21	0.90							22X26	1.12	25X21	1.12						
220		22X26	1.04							22X26	1.25	25X21	1.20						
270		22X26	1.23	25X26	1.32					22X26	1.5	25X26	1.25						
330		22X31	1.47	25X26	1.47					22X31	1.7	25X26	1.50	30X21	1.70				
				25X21	1.35														
390		22X36	1.56	25X31	1.58					22X36	1.92	25X31	1.70	30X26	1.92				
				22X31	1.46	25X26	1.46												
470		22X36	1.75	25X31	1.75	30X26	1.75			22X41	2.2	25X31	1.92	30X26	2.20				
560		22X41	2.09	25X36	2.09	30X31	2.09	35X27	2.09			25X36	2.20	30X31	2.52	35X27	2.52		
						25X31	1.92	30X26	1.92										
680		22X46	2.18	25X41	2.18	30X31	2.18	35X27	2.18			25X41	2.52	30X36	2.80	35X27	2.80		
						25X36	2.05												
820				25X46	2.34	30X36	2.34	35X32	2.34			25X46	2.80	30X41	3.15	35X32	3.15		
		22X51	2.21	25X41	2.21														
1000				25X51	3.04	30X41	3.04	35X32	3.04					30X46	3.60	35X37	3.60		
1200						30X51	3.51	35X37	3.51					30X56	3.9	35X42	3.90		
				25X56	3.30	30X46	3.30												
1500						30X56	3.65	35X42	3.65							35X47	4.50		
1800								35X52	3.80							35X63	4.60		
2200								35X57	3.99							35X70	4.72		

Ripple Current (A, rms) at 85°C 120Hz

φ DxL(mm)

Cap (μF)	φ D	WV															
		350								400							
		22		25		30		35		22		25		30		35	
		Size	Ripple	Size	Ripple	Size	Ripple	Size	Ripple	Size	Ripple	Size	Ripple	Size	Ripple	Size	Ripple
47										22x21	0.42						
68										22x21	0.51						
82										22x26	0.83						
100		22x26	0.76							22x26	0.95	25x21	0.95				
120		22x26	0.89	25x26	0.89					22x26	1.07	25x21	1.07				
150		22x31	0.99	25x26	0.99	30x21	0.99			22x31	1.26	25x26	1.26	30x21	1.26		
180		22x36	1.15	25x31	1.15	30x26	1.15			22x36	1.46	25x31	1.46	30x26	1.46		
220		22x41	1.40	25x36	1.40	30x26	1.40	35x22	1.40	22x41	1.75	25x36	1.75	30x31	1.75		
												25x31	1.62	30x26	1.62		
270				25x41	1.63	30x31	1.63	35x27	1.63			25x41	1.85	30x31	1.85	35x27	1.85
										22x46	1.73	25x36	1.73				
330				25x46	1.88	30x36	1.88	35x27	1.88			25x46	2.10	30x36	2.10	35x32	2.10
										22x51	1.98	25x41	1.98	30x31	1.98	35x27	1.98
390						30x36	2.12	35x32	2.12					30x41	2.35	35x37	2.35
										22x56	2.20	25x51	2.20	30x36	2.20	35x32	2.20
470						30x41	2.41	35x37	2.41							35x42	2.60
												25x56	2.45	30x41	2.45	35x37	2.45
560								35x42	2.80							35x47	2.95
														30x46	2.90	35x42	2.90
680								35x47	3.20							35x47	3.15
														30x56	3.05		

Cap (μF)	φ D	WV																	
		420									450								
		22		25		30		35		22		25		30		35		40	
		Size	Ripple	Size	Ripple	Size	Ripple	Size	Ripple	Size	Ripple	Size	Ripple	Size	Ripple	Size	Ripple	Size	Ripple
47		22x21	0.38							22x21	0.36								
68		22x26	0.49							22x26	0.60								
82		22x31	0.85	25x26	0.85					22x26	0.89	25x21	0.89						
		22x26	0.79	25x21	0.79														
100		22x36	1.03	25x26	1.03					22x31	1.03	25x26	1.03						
		22x31	0.96																
120		22x36	1.12	25x31	1.12					22x36	1.10	25x31	1.10						
		22x31	1.04	25x26	1.04														
150		22x41	1.32	25x36	1.32	30x31	1.32			22x41	1.30	25x36	1.30	30x26	1.30				
		22x36	1.34	25x31	1.34	30x26	1.34			22x36	1.13	25x31	1.13	30x21	1.13				
180				25x41	1.48	30x31	1.48			22x46	1.45	25x41	1.45	30x31	1.45				
		22x36	1.4	25x36	1.40	30x26	1.40			22x41	1.36	25x36	1.36	30x26	1.36				
220				25x46	1.75	30x36	1.75	35x32	1.75	22x51	1.65	25x46	1.65	30x36	1.65	35x27	1.65		
		22x41	1.65	25x41	1.65	30x31	1.65	35x27	1.65			25x41	1.55	30x31	1.55				
270				25x51	1.98	30x41	1.98	35x37	1.98			25x51	1.90	30x41	1.90	35x32	1.90		
		22x46	1.88	25x46	1.88	30x36	1.88	35x32	1.88			25x46	1.80	30x36	1.80				
330								35x42	2.27			25x56	2.20	30x41	2.20	35x37	2.20		
				25x51	2.15	30x41	2.15	35x37	2.15							35x32	2.10		
390								35x47	2.52							35x42	2.40	40x32	2.40
				25x56	2.40	30x46	2.40	35x42	2.40							35x37	2.30		
470						30x51	2.50	35x47	2.50							35x47	2.75	40x37	2.75
																35x42	2.60		
560						30x56	2.98	35x52	2.98							35x52	2.90	40x42	2.90
																35x47	2.78		
680								35x57	3.20							35x57	3.0	40x47	3.0
820																35x63	3.2	40x57	3.2

Ripple Current (A, rms) at 85°C 120Hz

LU Series Snap-in Type 85°C

LP **Long life** → LU



Features

- ◆ Endurance 3000 hours 85°C
- ◆ RoHS compliant

Specifications

Item	Performance Characteristics						
Operating Temperature Range	-40 to +85°C	-25 to +85°C					
Capacitance Range	820 to 47000uF	56 to 2700uF					
Rated Voltage Range	16 to 100VDC	160 to 450VDC					
Capacitance Tolerance	±20%(120Hz,+20°C)	±20%(120Hz,+20°C)					
Leakage Current (+20°C,max.)	$I \leq 3 \sqrt{CV}$ (μA) (After 5 minute with rated working voltage applied.) I= Leakage Current(μA) C= Rated Capacitance V= Rated voltage(V)						
Dissipation Factor (tan δ) (+20°C, at 120Hz)	Less than the value under table (%)						
	Cap(μF) / W.V.(V)	16	25~35	50~63	80~100	160~250	315~450
	56~390	-	-	-	-	15	20
	470~3900	25	20	20	20	15	20
	4700~8200	35	30	30	25	-	-
	10000~22000	40	35	30	25	-	-
27000~47000	45	40	35	-	-	-	
Low Temperature Characteristics (120Hz)	Impedance ratio max						
	Working voltage(VDC)	16	25~100	160~250	315~450		
	Z-25°C / Z+20°C	5	4	4	8		
	Z-40°C/Z+20°C	20	20	-	-		
Endurance	Test condition Duration time :3000Hrs Ambient temperature :+85°C Applied voltage :Rated DC working voltage After test requirement at +20°C Capacitance change : ≤ ±20% of the initial measured value Dissipation factor : ≤200% of the initial specified value Leakage current : ≤The initial specified value						
Shelf Life	Test condition Duration time :1000Hrs Ambient temperature :+85°C Applied voltage :None After test requirement at +20°C:Same limits as Endurance. Pre-treatment for measurements shall be conducted after application of DC working voltage for 30 minutes.						

Multiplier for Ripple Current vs. Frequency

CAP (μF) \ Hz	50(60)	120	1K	10K	50K-100K
10<CAP ≤ 100	0.8	1	1.36	1.48	1.53
100<CAP ≤ 1000	0.8	1	1.25	1.35	1.38
1000<CAP	0.8	1	1.17	1.25	1.28

Diagram of Dimensions:(unit:mm)

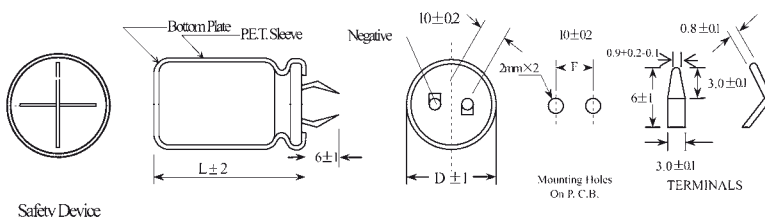

Case Size

φ DxL(mm)

WV (V) Cap(μF)	16		25		35		50		63	
	Size	Ripple	Size	Ripple	Size	Ripple	Size	Ripple	Size	Ripple
1800									22x26	1.90
2200							22x26	1.93	22x31	2.00
2700									25x26	2.0
3300							22x31	2.21	22x36	2.50
3900									25x31	2.52
4700							22x31	3.41	22x36	2.72
5600							25x26	2.38	25x31	2.74
6800									30x26	2.84
8200					22x26	2.22	22x36	2.72	22x41	3.09
10000							25x31	2.68	25x36	3.13
12000									30x31	3.09
15000					22x31	2.46	22x41	3.02	22x51	3.69
18000					25x26	2.43	25x31	3.07	25x41	3.59
22000							30x26	3.01	30x31	3.54
27000			22x26	2.31	22x36	2.79	22x46	3.43	25x46	4.01
33000					25x31	2.75	25x36	3.47	30x36	4.00
39000							30x31	3.43	35x32	3.75
47000			22x31	2.56	22x41	2.97	22x51	3.94	25x50	4.52
			25x26	2.47	25x31	2.89	25x41	3.87	30x41	4.55
					30x26	3.09	30x36	3.93	35x32	4.44
	22x26	2.56	22x36	2.86	22x46	3.47	25x46	4.44	30x46	5.12
			25x26	2.78	25x36	3.33	30x36	4.47	35x37	5.05
					30x31	3.29	35x32	4.41		
	22x31	2.98	22x36	3.31	22x51	3.75	30x41	5.08	30x51	5.78
			25x31	3.16	25x41	3.65	35x37	4.92	35x42	5.75
					30x31	3.61				
	22x31	3.13	22x41	3.77	25x46	4.15	30x51	5.72	35x47	6.47
	25x26	3.01	25x36	3.63	30x36	4.14	35x42	5.69		
			30x26	3.8	35x32	4.27				
	22x36	3.69	22x51	4.21	25x51	4.8	35x47	6.56		
	25x31	3.64	25x41	4.1	30x41	4.8				
	30x26	3.73	30x31	4	35x37	4.95				
	22x41	3.98	25x46	4.68	30x46	5.3				
	25x36	3.98	30x36	4.66	35x42	5.71				
	30x31	3.88	35x32	4.68						
	22x51	4.52	25x51	5.19	35x47	6.38				
	25x41	4.44	30x41	5.33						
	30x31	4.38	35x37	5.26						
	25x46	4.98	30x46	6.02	35x52	6.9				
	30x36	4.95	35x42	6.02						
	35x32	4.82								
	25x51	5.49	35x47	6.75						
	30x41	5.60								
	35x32	5.46								
	30x46	6.21	35x52	7.56						
	35x37	6.12								
	30x51	6.93								
	35x42	6.89								

Ripple Current(A rms) at 85°C /120Hz

φ DxL(mm)

WV (V) Cap(uF)	80		100		160		200		250	
	Size	Ripple	Size	Ripple	Size	Ripple	Size	Ripple	Size	Ripple
220									22x26	1.26
270							22x26	1.39	22x26	1.50
330							22x26	1.51	22x31	1.66
									25x26	1.61
390					22x26	1.63	22x31	1.73	22x36	1.88
							25x26	1.71	25x31	1.88
470					22x31	1.9	22x31	1.93	22x36	2.10
					25x26	1.86	25x26	1.95	25x36	2.15
									30x26	2.04
560					22x31	2.15	22x36	2.18	22x41	2.48
					25x26	2.15	25x31	2.15	25x36	2.35
							30x26	2.15	30x26	2.35
680					22x36	2.35	22x41	2.48	25x41	2.67
					25x31	2.33	25x31	2.48	30x31	2.71
					30x26	2.33	30x26	2.48		
820			22x26	1.86	22x41	2.68	22x46	2.81	25x46	3.01
					25x31	2.65	25x36	2.78	30x35	2.98
					30x26	2.64	30x31	2.80	35x32	2.96
1000			22x31	2.02	22x46	3.02	22x51	3.28	30x41	3.56
					25x36	3	25x41	3.28	35x37	3.48
					30x31	2.96	30x36	3.15		
1200	22x26	1.77	22x31	2.12	25x41	3.43	30x36	3.61	30x46	3.99
			25x26	2.11	30x31	3.41	35x32	3.57	35x37	3.84
					35x27	3.4				
1500	22x31	2.01	22x36	2.45	25x51	3.96	30x46	4.13	35x42	4.33
			25x31	2.47	30x36	3.96	35x37	4.06		
			30x26	2.56	35x32	3.94				
1800	22x31	2.11	22x41	2.77	30x41	4.31	30x51	4.60	35x52	4.54
	25x26	2.26	25x36	2.81	35x37	4.28	35x42	4.59		
			30x26	2.65						
2200	22x36	2.53	22x46	3.15	30x51	4.96	35x47	5.25		
	25x31	2.53	25x41	3.21	35x42	4.96				
	30x26	2.56	30x31	3.17						
2700	22x41	2.93	25x46	3.66	35x47	5.57				
	25x36	2.93	30x36	3.65						
	30x31	2.91	35x32	3.77						
3300	22x46	3.23	25x51	4.15						
	25x41	3.29	30x41	4.18						
	30x31	3.25	35x37	4.07						
3900	22x51	3.62	30x46	4.67						
	25x46	3.71	35x37	4.61						
	30x36	3.70								
4700	25x51	4.28	30x51	5.26						
	30x41	4.23	35x42	5.23						
	35x32	4.12								
5600	30x46	4.70	35x47	5.88						
	35x37	4.64								
6800	30x51	5.27	35x52	6.01						
	35x42	5.24								

Ripple Current(A rms) at 85°C /120Hz

φ DxD(mm)

WV (V) Cap(μF)	350		400		450	
	Size	Ripple	Size	Ripple	Size	Ripple
68					22x26	0.71
82			22x26	0.84	22x26	0.86
100			22x26	0.95	22x31	0.95
					25x26	0.97
120	22x26	1.04	22x31	1.09	22x36	1.07
			25x26	1.13	25x31	1.09
					30x26	1.12
150	22x31	1.2	22x36	1.24	22x41	1.18
	25x26	1.22	25x31	1.27	25x31	1.25
					30x26	1.29
180	22x31	1.34	22x41	1.41	22x46	1.32
	25x26	1.37	25x31	1.44	25x36	1.40
			30x26	1.52	30x31	1.45
220	22x36	1.47	22x46	1.58	25x41	1.59
	25x31	1.53	25x36	1.64	30x31	1.64
	30x26	1.54	30x31	1.66	35x27	1.59
270	22x41	1.7	25x41	1.79	30x36	1.89
	25x36	1.73	30x31	1.82	35x32	1.90
	30x26	1.8				
330	22x46	1.87	25x46	2	30x41	2.12
	25x36	1.97	30x36	2.05	35x37	2.15
	30x31	2.03	35x32	2.05		
390	25x41	2.14	30x41	2.26	30x46	2.35
	30x36	2.23	35x37	2.28	35x42	2.38
	35x32	2.3				
470	25x51	2.55	30x46	2.51	35x47	2.68
	30x36	2.53	35x37	2.51		
	35x32	2.55				
560	30x41	2.73	30x51	2.85	35x52	2.88
	35x37	2.75	35x42	2.85		
680	30x51	3.15	35x52	3.1		
	35x42	3.15				
820	35x47	3.47				
1000	35x52	3.6				
1200						
1500						

Ripple Current(A rms) at 85°C /120Hz

HP Series Snap-in Type 105°C

Features

- ◆ Highly reliable capacitors that with high ripple current.
- ◆ Terminal spacing fixed at 10 mm for printed circuit board plug in.
- ◆ Aluminum case designed explosion-proof vent.
- ◆ Best for switching power supplies.
- ◆ RoHS Compliant



Specifications

Item	Performance Characteristics										
Operating Temperature Range	-40 to +105°C	-25 to +105°C									
Rated Voltage Range	10 to 100 VDC	160 to 450 VDC									
Capacitance Range	330 to 68000 µ F	33 to 2200 µ F									
Capacitance Tolerance	± 20% (120Hz, +20°C)										
Leakage Current (+20°C, max.)	I ≤ 0.02CV After 5 minutes with rated working voltage applied.										
Dissipation Factor (tan δ , at 20°C , 120Hz)	Less than the value under table (%)										
	µ F \ VDC	10~16	25~35	50~63	80~100	160~250	315~450				
	47~390	—	—	—	15	15	20				
	470~3900	25	20	20	20	15	20				
	4700~8200	35	30	30	25	—	—				
	10000~22000	40	35	30	—	—	—				
	27000~47000	45	40	35	—	—	—				
Low Temperature Characteristics (at 120Hz)	Impedance ratio max.										
	Rated voltage(V)	10	16	25	35	50	63	100	160	200~250	400~450
	Z - 25°C / Z+20°C	5	5	4	4	4	4	4	4	4	8
Endurance	Test conditions										
	Duration time	:2000 Hrs									
	Ambient temperature	:+105°C									
	Applied voltage	:Rated DC working voltage									
	After test requirement at +20°C	Capacitance change : ≤ ±20% of the initial measured value Dissipation factor : ≤ 200% of the initial specified value Leakage current : ≤ The initial specified value									
Shelf Life	Test conditions										
	Duration time	:1000 Hrs									
	Ambient temperature	:+105°C									
	Applied voltage	:None									
	After test requirement at +20°C	: Same limits as Endurance. Pre-treatment for measurements shall be conducted after application of DC working voltage for 30 minutes.									

Multiplier for Ripple Current vs. Frequency

CAP(µ F) \ Frequency(Hz)	50(60)	120	400	1K	10K	50K-100K
10 < CAP ≤ 100	0.8	1	1.23	1.36	1.48	1.53
100 < CAP ≤ 1000	0.8	1	1.16	1.25	1.35	1.38
1000 < CAP	0.8	1	1.11	1.17	1.25	1.28

Diagram of Dimensions:(unit:mm)

SYMBOL G : P.C.B. TERMINAL (SNAP-IN)

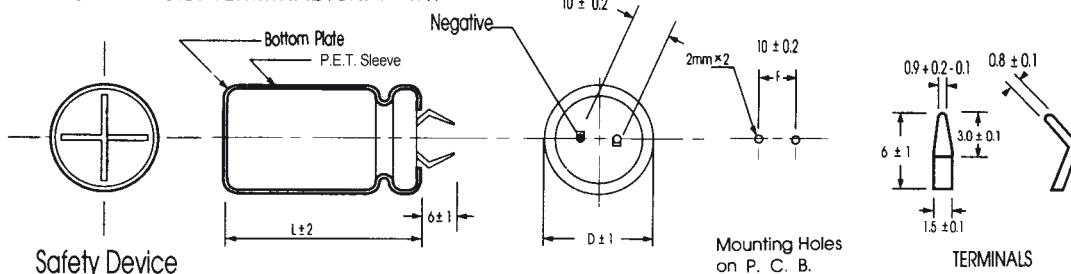

Case Size

φ DxL(mm)

Cap (μF)	φ D	10								16							
		22		25		30		35		22		25		30		35	
		Size	Ripple	Size	Ripple	Size	Ripple	Size	Ripple	Size	Ripple	Size	Ripple	Size	Ripple	Size	Ripple
3300										22x26	1.17						
4700		22x26	1.24							22x26	1.53	25x26	1.55				
6800		22x26	1.56	25x26	1.56					22x31	1.65						
8200		22x26	2.04	25x26	2.04					22x31	2.02	25x26	2.02	30x26	2.02		
10000		22x31	2.20	25x26	2.20	30x26	2.20			22x31	2.79	25x26	2.79	30x26	2.81		
12000		22x31	2.34							22x36	2.97	25x31	2.97				
		22x36	2.49	25x26	2.40					22x36	3.06	25x31	3.06	30x26	3.06		
15000		22x36	2.76	25x26	2.60	30x26	2.80			22x41	3.24	25x36	3.24	30x26	3.24	35x32	3.24
				25x31	2.76							25x41	3.42				
18000		22x36	2.94	25x31	2.94					22x51	3.51	25x46	3.51	30x36	3.51	35x32	3.54
22000		22x41	3.12	25x36	3.12	30x26	3.08	35x27	3.20			25x46	4.08	30x36	4.08	35x32	4.08
						30x31	3.30					25x51	4.25				
27000		22x46	3.48	25x36	3.48	30x31	3.48	35x27	3.48			25x51	4.30	30x41	4.30	35x32	4.30
				25x46	3.72	30x36	3.72	35x27	3.65					30x46	4.83	35x37	4.83
33000								35x32	3.85								
39000				25x51	4.10	30x41	4.10	35x32	4.10					30x51	5.78	35x42	5.78
47000						30x46	4.38	35x37	4.38							35x47	6.32
56000						30x51	4.64	35x42	4.64							35x52	7.05
68000								35x52	4.80								

Cap (μF)	φ D	25								35							
		22		25		30		35		22		25		30		35	
		Size	Ripple	Size	Ripple	Size	Ripple	Size	Ripple	Size	Ripple	Size	Ripple	Size	Ripple	Size	Ripple
1500										22x26	1.26						
2200		22x26	1.03							22x26	1.35	25x26	1.45				
										22x31	1.45						
3300		22x26	1.48	25x26	1.48					22x26	1.80	25x26	1.90	30x26	1.92		
										22x31	1.90						
3900										22x31	2.23						
4700		22x26	1.88	25x26	1.90	30x26	1.92			22x36	2.42	25x26	2.30	30x26	2.54		
		22x31	1.92									25x31	2.44				
5600		22x31	2.25							22x36	2.89	25x31	2.89	30x26	2.89		
6800		22x31	2.60	25x26	2.60	30x26	2.60			22x41	3.24	25x36	3.24	30x26	3.21	35x27	3.24
														30x31	3.43		
8200		22x36	3.14	25x31	3.14	30x26	3.14			22x51	3.57	25x41	3.57	30x31	3.57	35x27	3.57
		22x41	3.50	25x36	3.50	30x31	3.50	35x27	3.50			25x46	3.96	30x36	3.96	35x27	3.75
10000																35x32	4.00
		22x46	4.02	25x41	4.02	30x31	4.02	35x27	4.02			25x51	4.21	30x41	4.21	35x32	4.21
15000				25x46	4.58	30x36	4.58	35x32	4.58					30x46	4.69	35x37	4.69
				25x51	4.82	30x41	4.82	35x32	4.79							35x42	5.07
18000								35x37	4.82								
22000						30x46	5.12	35x37	5.12							35x52	5.50
								35x42	5.30								
27000								35x47	5.47								
								35x52	6.09								
33000																	

Cap (μF)	φ D	50								63							
		22		25		30		35		22		25		30		35	
		Size	Ripple	Size	Ripple	Size	Ripple	Size	Ripple	Size	Ripple	Size	Ripple	Size	Ripple	Size	Ripple
680										22x26	0.70						
1000		22x26	0.84							22x26	0.85	25x26	0.85				
										22x26	0.98						
1500		22x26	1.10	25x26	1.12					22x26	1.10	25x26	1.12	30x26	1.14		
		22x31	1.12							22x31	1.15						
1800		22x26	1.50							22x31	1.40	25x26	1.40				
		22x31	1.62														
2200		22x31	1.65	25x26	1.65	30x26	1.65			22x36	1.65	25x31	1.65	30x26	1.65		
		22x31	1.85	25x26	1.85					22x41	2.07	25x36	2.07	30x26	2.07		
2700		22x36	1.97	25x31	1.98												
		22x36	2.24	25x31	2.24	30x26	2.24			22x46	2.46	25x36	2.40	30x31	2.48	35x27	2.48
3300										22x51	2.55	25x41	2.54				
		22x41	2.54	25x36	2.54	30x26	2.49					25x41	2.92	30x36	3.05	35x27	3.05
3900						30x31	2.66					25x46	3.07				
		22x46	2.95	25x36	2.80	30x31	2.95	35x27	2.95			25x51	3.43	30x41	3.43	35x32	3.43
4700				25x41	3.01												
		22x51	3.10	25x41	3.02	30x36	3.14	35x27	3.10					30x46	3.86	35x37	3.86
5600				25x46	3.15	30x41	3.20	35x32	3.20								
				25x46	3.23	30x41	3.26	35x32	3.26					30x51	4.64	35x42	4.64
6800				25x51	3.35												
8200						30x46	3.58	35x37	3.58							35x47	5.05
10000						30x51	4.11	35x42	4.11							35x52	5.75
12000								35x47	4.62								
15000								35x52	5.05								

φ DxL(mm)

Cap (μF)	WV	φ D	80								100							
			22		25		30		35		22		25		30		35	
			Size	Ripple	Size	Ripple	Size	Ripple	Size	Ripple	Size	Ripple	Size	Ripple	Size	Ripple	Size	Ripple
330										22x26	0.54							
470			22x26	0.63						22x26	0.79	25x26	0.81					
560			22x26	0.70						22x31	0.85							
			22x31	0.75						22x26	0.90	25x26	0.95					
680			22x26	0.81	25x26	0.86				22x31	0.97							
			22x31	0.87						22x31	1.02	25x26	1.02	30x26	1.14			
820			22x31	1.02	25x26	1.02				22x31	1.26	25x26	1.26	30x26	1.32			
					25x31	1.09												
1000			22x31	1.11	25x31	1.16	30x26	1.16		22x36	1.38	25x31	1.38	30x26	1.38			
			22x36	1.18														
1200			22x36	1.46	25x31	1.46	30x26	1.46		22x41	1.65	25x36	1.65	30x31	1.65			
							30x31	1.56										
1500			22x41	1.74	25x36	1.74	30x26	1.70		22x46	1.83	25x41	1.83	30x31	1.83	35x27	1.83	
							30x31	1.82										
1800			22x46	1.95	25x36	1.89	30x31	1.95	35x27	1.95			25x41	2.52	30x36	2.52	35x32	2.52
					25x41	1.99												
2200			22x51	2.25	25x41	2.20	30x31	2.20	35x27	2.25			25x51	3.03	30x41	3.03	35x32	3.03
					25x46	2.31	30x36	2.31	35x32	2.40								
2700					25x46	2.58	30x36	2.58	35x32	2.68					30x46	4.10	35x37	4.10
					25x51	2.70	30x41	2.72	35x37	2.85								
3300					25x51	3.30	30x41	3.30	35x37	3.30					30x56	4.59	35x47	4.59
					25x56	3.45	30x46	3.50	35x42	3.50								
3900							30x46	3.73	35x37	3.73							35x47	4.98
							30x51	3.90	35x42	3.93								
4700							30x51	4.29	35x42	4.29							35x52	5.43
5600									35x47	5.10								
6800									35x52	5.66								

Cap (μF)	WV	φ D	160								200							
			22		25		30		35		22		25		30		35	
			Size	Ripple	Size	Ripple	Size	Ripple	Size	Ripple	Size	Ripple	Size	Ripple	Size	Ripple	Size	Ripple
100										22x26	0.38							
150			22x26	0.37						22x26	0.54	25x26	0.54					
220			22x26	0.42						22x31	0.92	25x26	0.92	30x26	0.92			
270			22x26	0.74						22x31	1.03	25x26	1.03	30x26	1.05			
330										22x26	1.05							
			22x31	0.98	25x26	0.98	30x26	1		22x31	1.13	25x26	1.13					
390			22x31	1.09	25x31	1.1	30x26	1.1		22x36	1.21	25x31	1.21	30x26	1.21			
			22x36	1.15						22x36	1.33	25x31	1.34	30x31	1.45			
470										22x41	1.41	25x36	1.43					
										22x31	1.39	25x30	1.47					
										22x35	1.46	25x31	1.49					
			22x36	1.21						22x36	1.48							
560					25x31	1.21	30x26	1.21		22x41	1.57	25x36	1.59	30x31	1.65	35x27	1.65	
										22x46	1.65	25x41	1.68					
										22x41	1.72	25x31	1.64					
			22x41	1.4	25x36	1.4	30x31	1.4	35x27	1.4	22x46	1.81	25x41	1.85	30x31	1.85	35x27	1.85
680										22x51	1.9	25x46	1.94	30x36	1.94			
										22x41	1.85							
			22x46	1.64	25x36	1.58	30x31	1.65	35x27	1.71	22x51	2.04	25x46	2.07	30x31	2.04	35x32	2.17
					25x41	1.67	30x36	1.75	35x32	1.8	22x56	2.12	25x51	2.17	30x36	2.17		
820					25x41	1.76	30x36	1.85	35x32	1.85	22x46	2.05	25x51	2.3	30x36	2.3	35x37	2.31
					25x46	1.85							25x56	2.4	30x41	2.4		
1000					25x46	2.05	30x41	2.15	35x32	2.15			25x46	2.36	30x41	2.62	35x37	2.62
					25x51	2.15									30x46	2.75	35x42	2.75
1200					25x56	2.46	30x46	2.46	35x37	2.46					30x51	3	35x42	3
1500							30x51	2.8	35x42	2.8							35x47	3.28
1800							30x51	3.13	35x42	3.13							35x52	3.46
2200									35x52	3.26							35x52	4.01
									35x57	3.39								

Cap (μF)	WV	φ D	220								250							
			22		25		30		35		22		25		30		35	
			Size	Ripple	Size	Ripple	Size	Ripple	Size	Ripple	Size	Ripple	Size	Ripple	Size	Ripple	Size	Ripple
68										22x26	0.27							
100										22x31	0.44	25x26	0.44					
150			22x26	0.5	25x26	0.5				22x31	0.6	25x26	0.6	30x26	0.6			
180			22x26	0.6	25x26	0.6				22x31	0.69	25x26	0.69	30x26	0.69			
220										22x26	0.87							
										22x31	0.94							
270			22x31	0.85	25x26	0.85	30x26	0.85		22x36	1	25x31	1	30x26	1			
			22x31	1.05	25x26	1.05	30x26	1.05		22x41	1.16	25x36	1.16	30x31	1.16			
330										22x36	1.15	25x31	1.2					
			22x41	1.25	25x31	1.2	30x26	1.25		22x46	1.28	25x36	1.28	30x31	1.28	35x27	1.28	
390					25x36	1.28	30x31	1.33		22x46	1.48	25x36	1.48	30x31	1.48	35x27	1.48	
470			22x41	1.28	25x36	1.31	30x31	1.35	35x27	1.35			25x41	1.76	30x36	1.76	35x32	1.76
			22x46	1.35	25x41	1.38							25x46	1.85				
560																		
			22x45	1.51														
680			22x51	1.6	25x46	1.6	30x36	1.6	35x27	1.6			25x51	1.93	30x41	1.93	35x32	1.93
			22x45	1.54														
820			22x56	1.7	25x51	1.75	30x41	1.75	35x32	1.75					30x46	2.22	35x37	2.22
					25x56	2	30x46	2	35x37	2					30x51	2.48	35x42	2.48
1000							30x51	2.3	35x42	2.3					30x51	2.66	35x42	2.67
1200									35x47	2.35							35x47	2.8
1500									35x52	2.4							35x52	3.17
1800									35x56	2.5								

Snap-in

φ DxL(mm)

Cap (μF)	φ D	400								420							
		22		25		30		35		22		25		30		35	
		Size	Ripple	Size	Ripple	Size	Ripple	Size	Ripple	Size	Ripple	Size	Ripple	Size	Ripple	Size	Ripple
33		22x26	0.39							22x26	0.32						
47		22x26	0.56	25x26	0.56					22x26	0.45	25x26	0.45				
56		22x26	0.63	25x26	0.68					22x26	0.52	25x26	0.52				
		22x31	0.68														
68		22x31	0.72	25x26	0.72	30x26	0.72			22x31	0.64	25x26	0.64	30x26	0.64		
82		22x31	0.77	25x31	0.82	30x26	0.85			22x31	0.75	25x31	0.75	30x26	0.75		
		22x36	0.82														
100		22x36	0.82	25x31	0.82	30x26	0.82			22x36	0.78	25x31	0.78	30x26	0.78		
120		22x36	0.90	25x31	0.90	30x26	0.90			22x36	0.84	25x36	0.84	30x26	0.84		
150		22x41	0.98	25x36	0.98	30x31	0.95	35x27	0.95	22x41	0.97	25x36	0.97	30x31	0.97		
180		22x46	1.14	25x41	1.14	30x36	1.14	35x32	1.14	22x46	1.02	25x41	1.02	30x36	1.02	35x27	1.02
220				25x46	1.21	30x41	1.21	35x32	1.21			25x46	1.22	30x41	1.22	35x32	1.22
270				25x51	1.40	30x46	1.40	35x37	1.40					30x46	1.50	35x37	1.50
330						30x51	1.57	35x42	1.57					30x51	1.68	35x42	1.68
390								35x42	1.71							35x47	1.76
								35x47	1.79								
470								35x47	1.94								
								35x52	2.03								
560								35x52	2.23								

Cap (μF)	φ D	450							
		22		25		30		35	
		Size	Ripple	Size	Ripple	Size	Ripple	Size	Ripple
33		22x26	0.24						
47		22x31	0.35	25x26	0.35				
56		22x31	0.41	25x26	0.41				
68		22x36	0.55	25x31	0.55	30x26	0.55		
82		22x36	0.64	25x31	0.64	30x26	0.64		
100		22x41	0.74	25x31	0.74	30x31	0.74		
120		22x46	0.82	25x36	0.82	30x31	0.82		
150		22x51	0.96	25x41	0.96	30x36	0.96	35x27	0.96
180				25x46	1.14	30x36	1.10	35x32	1.14
						30x41	1.16		
220				25x46	1.24	30x41	1.24	35x37	1.24
						30x46	1.30		
270						30x51	1.48	35x42	1.48
330						30x51	1.64	35x47	1.64
390								35x52	1.86
470									
560									

Ripple Current (A, rms) at 105°C 120Hz

HS Series Snap-in Type 105°C Miniaturized

Features

- ◆ Highly reliable capacitors that withstand ripple current.
- ◆ Terminal spacing fixed at 10 mm for printed circuit board plug in.
- ◆ Aluminum case designed explosion-proof vent.
- ◆ Best for switching power supplies.
- ◆ RoHS Compliant



Specifications

Item	Performance Characteristics									
Operating Temperature Range	-25 to +105°C									
Rated Voltage Range	160 to 450 V · DC									
Capacitance Range	33 to 2700 µ F									
Capacitance Tolerance	± 20% (120Hz, +20°C)									
Leakage Current (+20°C,max.)	$I \leq 0.02CV$ After 5 minutes with rated working voltage applied.									
Dissipation Factor ($\tan \delta$, at 20°C , 120Hz)	Less than the value under table (%)									
	<table border="1"> <thead> <tr> <th>µ F \ VDC</th> <th>160~250</th> <th>315~450</th> </tr> </thead> <tbody> <tr> <td>47~390</td> <td>15</td> <td>20</td> </tr> <tr> <td>470~2700</td> <td>15</td> <td>20</td> </tr> </tbody> </table>	µ F \ VDC	160~250	315~450	47~390	15	20	470~2700	15	20
	µ F \ VDC	160~250	315~450							
47~390	15	20								
470~2700	15	20								
Low Temperature Characteristics (at 120Hz)	Impedance ratio Max									
	<table border="1"> <thead> <tr> <th>Working voltage (VDC)</th> <th>160</th> <th>200~250</th> <th>400~450</th> </tr> </thead> <tbody> <tr> <td>Z -25°C / Z +20°C</td> <td>4</td> <td>4</td> <td>8</td> </tr> </tbody> </table>	Working voltage (VDC)	160	200~250	400~450	Z -25°C / Z +20°C	4	4	8	
Working voltage (VDC)	160	200~250	400~450							
Z -25°C / Z +20°C	4	4	8							
Endurance	Test conditions Duration time :2000 Hrs Ambient temperature :+105°C Applied voltage :Rated DC working voltage After test requirement at +20°C Capacitance change : $\leq \pm 20\%$ of the initial measured value Dissipation factor : $\leq 200\%$ of the initial specified value Leakage current : \leq The initial specified value									
Shelf Life	Test conditions Duration time :1000 Hrs Ambient temperature :+105°C Applied voltage :None After test requirement at +20°C : Same limits as Endurance. Pre-treatment for measurements shall be conducted after application of DC working voltage for 30 minutes.									

Multiplier for Ripple Current vs. Frequency

CAP(µ F) \ Frequency(Hz)	50(60)	120	400	1K	10K	50K-100K
10 < CAP ≤ 100	0.8	1	1.23	1.36	1.48	1.53
100 < CAP ≤ 1000	0.8	1	1.16	1.25	1.35	1.38
1000 < CAP	0.8	1	1.11	1.17	1.25	1.28

Diagram of Dimensions:(unit:mm)

SYMBOL G : P.C.B. TERMINAL (SNAP-IN)

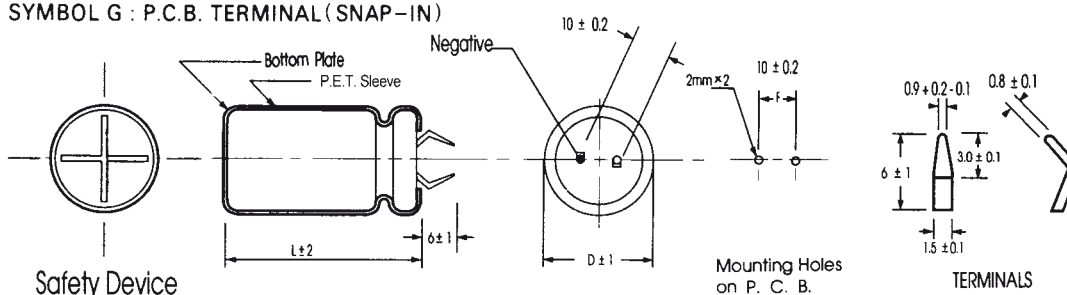

Case Size

φ D x L (mm)

Cap (μF)	φ D	WV	160								200							
			22		25		30		35		22		25		30		35	
			Size	Ripple	Size	Ripple	Size	Ripple	Size	Ripple	Size	Ripple	Size	Ripple	Size	Ripple	Size	Ripple
100										22X21	0.38							
150			22X21	0.37						22X21	0.54	25X21	0.54					
220			22X21	0.65						22X26	0.92	25X21	0.92	30X21	0.92			
270			22X21	0.74						22X26	1.03	25X21	1.03	30X21	1.03			
330			22X26	0.98	25X21	0.98	30X21	0.98		22X31	1.21	25X26	1.21	30X21	1.21			
										22X26	1.10	25X21	1.10					
390			22X26	1.10	25X26	1.10	30X21	1.10		22X31	1.39	25X26	1.39	30X26	1.39			
					25X21	1.00								30X21	1.27			
470			22X31	1.21	25X26	1.21	30X21	1.21		22X36	1.45	25X31	1.45	30X26	1.45	35X22	1.45	
										22X31	1.35	25X26	1.35					
560			22X36	1.40	25X31	1.40	30X26	1.40		22X41	1.60	25X36	1.60	30X26	1.60	35X22	1.60	
			22X31	1.30	25X26	1.30				22X36	1.50	25X31	1.50					
680			22X41	1.64	25X31	1.64	30X26	1.64	35X27	1.64	22X46	1.80	25X36	1.80	30X31	1.80	35X27	1.80
			22X36	1.53						22X41	1.70							
820					25X36	1.85	30X31	1.85	35X27	1.85	22X46	1.79	25X41	2.00	30X31	2.00	35X32	2.00
			22X51	1.70						22X51	1.88	25X36	1.88			35X27	1.88	
1000					25X46	2.15	30X31	2.15	35X27	2.15			25X51	2.30	30X36	2.30	35X32	2.30
			22X56	2.03	25X41	2.03						25x46	2.20					
1200					25X51	2.46	30X41	2.46	35X32	2.46					30X41	2.70	35X37	2.70
1500							30X46	2.46	35X37	2.46					30X51	3.10	35X42	3.10
1800							30X51	3.13	35X42	3.13					30X70	3.75	35X47	3.75
2200							30X70	3.39	35X47	3.39							35X57	3.82
2700									35X52	3.90							35X70	4.00

Cap (μF)	φ D	WV	220								250							
			22		25		30		35		22		25		30		35	
			Size	Ripple	Size	Ripple	Size	Ripple	Size	Ripple	Size	Ripple	Size	Ripple	Size	Ripple	Size	Ripple
68										22X21	0.27							
82										22X21	0.34							
100										22X21	0.44	25X21	0.44					
120										22X26	0.48	25X21	0.48					
150			22X21	0.57						22X26	0.60	25X21	0.60	30X21	0.60			
180			22X26	0.61	25X26	0.61				22X26	0.69	25X26	0.69	30X21	0.69			
					25X21	0.55						25X21	0.63					
220			22X26	0.81	25X26	0.81				22X31	1.00	25X26	1.00	30X21	1.00			
										22X26	0.92	25X21	0.92					
270			22X31	1.01	25X26	1.01	30X26	1.01		22X36	1.16	25X31	1.16	30X26	1.16			
			22X26	0.93			30X21	0.93		22X31	1.05	25X26	1.05	30X21	1.05			
330			22X31	1.09	25X26	1.09	30X26	1.09		22X41	1.28	25X31	1.28	30X26	1.28			
										22X36	1.20	25X26	1.20					
390			22X36	1.18	25X31	1.18	30X26	1.18		22X41	1.48	25X31	1.48	30X31	1.48			
					25X26	1.08				22X36	1.38			30X26	1.38			
470			22X41	1.28	25X36	1.28	30X26	1.28		22X46	1.65	25X36	1.65	30X31	1.65	35X27	1.65	
			22X36	1.2	25X31	1.2				22X41	1.55							
560			22X46	1.52	25X41	1.52	30X31	1.52	35X27	1.52		25X46	1.85	30X36	1.85	35X27	1.85	
			22X41	1.4	25X36	1.4	30X26	1.4		22X51	1.75	25X41	1.75	30X31	1.75			
680			22X51	1.66	25X46	1.66	30X36	1.66	35X27	1.66				30X41	2.00	35X32	2.00	
			22X46	1.56	25X41	1.56	30X31	1.56				25X51	1.85					
820					25X51	1.9	30X41	1.9	35X32	1.9				30X46	2.30	35X37	2.30	
					25X46	1.8	30X36	1.8										
1000							30X46	2.28	35X37	2.28					30X56	2.50	35X42	2.60
					25X56	2.15	30X41	2.15						30X61	2.60			
1200							30X51	2.32	35X42	2.32							35X47	2.85
1500							30X70	2.35	35X47	2.35							35X63	2.92
1800									35X52	2.40							35X70	2.95
2200									35X63	2.45								

Ripple Current (A, rms) at 105°C 120Hz

φ D x L (mm)

Cap (μF)	φ D	WV															
		350								400							
		22		25		30		35		22		25		30		35	
		Size	Ripple	Size	Ripple	Size	Ripple	Size	Ripple	Size	Ripple	Size	Ripple	Size	Ripple	Size	Ripple
33										22X21	0.39						
47										22X21	0.56	25X21	0.56				
56										22X21	0.60	25X21	0.60				
68		22X21	0.45							22x21	0.62	25X21	0.65				
82		22X26	0.53							22X26	0.65						
100		22X26	0.65							22X26	0.75	25X26	0.75				
120		22X31	0.74	25X26	0.74					25X21	0.71						
150		22X26	0.68							22X31	0.78	25X26	0.78	30X21	0.78		
180		22X31	0.74	25X26	0.74					22X26	0.72						
220		22X36	0.80	25X31	0.80					22X31	0.85	25X26	0.85	30X21	0.85		
270		22X31	0.74	25X26	0.74					22X26	0.79						
330		22X41	0.95	25X31	0.95	30X26	0.95			22X36	0.98	25X31	0.98	30X26	0.98		
390		22X36	0.89	25X26	0.89					22X31	0.91	25X26	0.91				
470		22X46	1.10	25X36	1.10	30X31	1.10			22X41	1.14	25X36	1.14	30X31	1.14	35X27	1.14
560		22X41	1.00	25X31	1.00	30X26	1.00			22X36	1.05	25X31	1.05	30X26	1.05		
680										22X51	1.21	25X41	1.21	30X36	1.21	35X27	1.21
820										22X46	1.1	25X36	1.10	30X31	1.10		
1000										22x41	1.05	25x31	1.05				
		22X51	1.20	25X41	1.20	30X31	1.20	35X27	1.20	22X51	1.40	25X46	1.40	30X41	1.40	35X32	1.40
		22X46	1.10	25X36	1.10	30X26	1.10			22X46	1.30	25X41	1.30	30X36	1.30	35X27	1.30
				25X46	1.30	30X36	1.30	35X32	1.30					30X41	1.57	35X37	1.57
		22X51	1.20	25X41	1.20	30X31	1.20	35X27	1.20	22X51	1.40	25X46	1.40	30X36	1.40	35X32	1.40
						30X41	1.45	35X37	1.45							35X37	1.74
		22X56	1.30	25X46	1.30	30X36	1.30	35X32	1.30	22X56	1.60	25X51	1.60	30X41	1.60	35X32	1.60
						30X46	1.70	35X37	1.70							35X42	1.98
				25X51	1.60	30X41	1.60	35X32	1.60					30X46	1.80	35X37	1.80
						30X46	1.70	35X42	1.85					30X56	2.23	35X47	2.23
								35X37	1.70					30x51	2.14	35X42	2.10
														30X46	2.10		
								35X47	1.98							35X52	2.40
								35X42	1.80								
								35X52	1.82							35X57	2.42
								35X63	1.84							35X70	2.45

Cap (μF)	φ D	WV															
		420								450							
		22		25		30		35		22		25		30		35	
		Size	Ripple	Size	Ripple	Size	Ripple	Size	Ripple	Size	Ripple	Size	Ripple	Size	Ripple	Size	Ripple
33		22X21	0.34							22X21	0.24						
47		22X21	0.45	25X21	0.45					22X26	0.35	25X21	0.35				
56		22X21	0.5	25X21	0.5	30X21	0.5			22x21	0.32						
68		22X26	0.58	25X21	0.58	30X21	0.58			22X26	0.41	25X21	0.41				
82		22X26	0.68	25X26	0.68	30X21	0.68			22X31	0.55	25X26	0.55	30X21	0.55		
100		22X26	0.68	25X26	0.68	30X21	0.68			22X26	0.51	25X21	0.51				
120		22X31	0.75	25X31	0.75	30X26	0.75			22X31	0.64	25X26	0.64	30X21	0.64		
150		22X36	0.83	25X31	0.83	30X21	0.69			22X31	0.69						
180		22X31	0.77	25X26	0.77	30X26	0.83			22X41	0.82	25X31	0.82	30X26	0.82		
220		22X41	0.97	25X36	0.97	30X26	0.97			22X36	0.77	25X26	0.77				
270		22X36	0.91	25X31	0.91					22X46	0.96	25X36	0.96	30X31	0.96		
330										22X41	0.91	25X31	0.91	30X26	0.91		
390										22x36	0.86						
470				25X41	1.08	30X31	1.08			22X46	0.99	25X41	1.05	30X31	1.05	35X27	1.05
560		22X41	1.02	25X36	1.02	30X26	1.02			22X41	0.94	25X36	0.99	30X26	0.99		
680												25X31	0.93				
820		22X51	1.18	25X46	1.18	30X36	1.18	35X27	1.18	22x51	1.15			30X36	1.15	35X32	1.15
				25X41	1.10	30X31	1.10			22x46	1.08	25X41	1.08	30X31	1.08	35X27	1.08
				25X46	1.30	30X41	1.42	35X32	1.42					30X46	1.48	35X37	1.48
				25X41	1.24	30X36	1.30					25X46	1.38	30X41	1.38	35X32	1.38
														30X36	1.31		
				25X51	1.45	30X46	1.56	35X37	1.56					30X46	1.45	35X42	1.55
				25X46	1.39	30X41	1.45	35X32	1.45					30X41	1.38	35X37	1.45
						30X46	1.65	35X42	1.76							35X47	1.75
								35X37	1.65							35X42	1.65
						30X51	1.68	35X47	1.78					30x51	1.68	35X52	1.85
						30X46	1.61	35X42	1.68							35X47	1.75
						30x51	1.64	35X52	1.80							35X52	1.86
								35X47	1.72								
								35X57	1.82								
								35X63	1.84								

Ripple Current (A, rms) at 105°C 120Hz

HW Series Snap-in Type 105°C 15mm Height

Features

- ◆ Endurance 2000 hours 105°C with height 15mm
- ◆ ROHS compliant

HS **Low Profile** HW



Specifications

Item	Performance Characteristics		
Operating Temperature Range	-25 to +105°C		
Capacitance Range	39 to 390µF		
Rated Voltage Range	160 to 400VDC		
Capacitance Tolerance	±20%(120Hz,+20°C)		
Leakage Current (+20°C,max.)	$I \leq 3 \sqrt{CV} (\mu A)$ (After 5 minute with rated working voltage applied.) I= Leakage Current(µA) C= Rated Capacitance V= Rated voltage(V)		
Dissipation Factor (tan δ) (+20°C, at 120Hz)	Cap(µF) / W.V.(V)	160~250	315~450
	D.F.	20%	20%
Low Temperature Characteristics (120Hz)	Impedance ratio max		
	Rated voltage	160~250	315~450
	Z-25°C/Z+20°C	4	8
Endurance	Test condition		
	Duration time	:2000Hrs	
	Ambient temperature	:+105°C	
	Applied voltage	:Rated DC working voltage	
	After test requirement at +20°C		
	Capacitance change	: ≤ ±20% of the initial measured value	
	Dissipation factor	: ≤ 200% of the initial specified value	
	Leakage current	: ≤ The initial specified value	
Shelf Life	Test condition		
	Duration time	:1000Hrs	
	Ambient temperature	:+105°C	
	Applied voltage	:None	
	After test requirement at +20°C:	Same limits as Endurance.	
	Pre-treatment for measurements shall be conducted after application of DC working voltage for 30 minutes.		

Multiplier for Ripple Current vs. Frequency

CAP (µF) \ Hz	50(60)	120	1K	10K	50K-100K
10<CAP≤100	0.8	1	1.36	1.48	1.53
100<CAP≤1000	0.8	1	1.25	1.35	1.38

Diagram of Dimensions:(unit:mm)

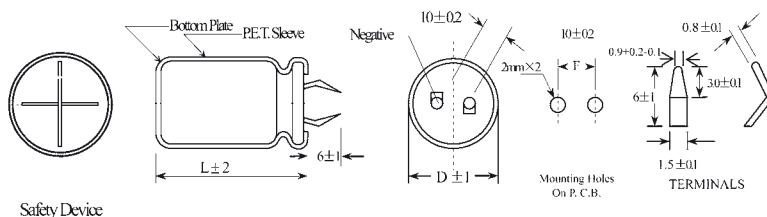

Case Size

φ DxL(mm)

WV (V) Cap(μF)	160		180		200		250		315		400	
	Size	Ripple	Size	Ripple	Size	Ripple	Size	Ripple	Size	Ripple	Size	Ripple
39											22x15	0.30
47											25x15	0.35
56									22x15	0.35	30x15	0.40
68									25x15	0.4	30x15	0.45
82									30x15	0.45	35x15	0.50
100					20x15	0.45	22x15	0.50	30x15	0.5	35x15	0.55
120			20x15	0.50	22x15	0.55	25x15	0.60	35x15	0.55		
150	20x15	0.55	22x15	0.60	25x15	0.65	30x15	0.70	35x15	0.6		
180	22x15	0.65	25x15	0.75	25x15	0.75	30x15	0.75				
					30x15	0.80						
220	25x15	0.80	30x15	0.85	30x15	0.90	35x15	0.90				
270	30x15	0.95	30x15	1.00	30x15	1.00	35x15	1.00				
330	30x15	1.00	35x15	1.10	35x15	1.10						
390	35x15	1.20	35x15	1.20								

Ripple Current(A rms) at 105°C /120Hz

HU Series Snap-in Type 105°C

HP **Long life** → HU



Features

- ◆ Endurance 3000 hours 105°C
- ◆ ROHS compliant

Specifications

Item	Performance Characteristics						
Operating Temperature Range	-40 to +105°C	-25 to +105°C					
Capacitance Range	560 to 47000uF	47 to 2700uF					
Rated Voltage Range	16 to 100VDC	160 to 450VDC					
Capacitance Tolerance	±20%(120Hz,+20°C)	±20%(120Hz,+20°C)					
Leakage Current (+20°C,max.)	$I \leq 3 \sqrt{CV}$ (μA) (After 5 minute with rated working voltage applied.) I= Leakage Current(μA) C= Rated Capacitance V= Rated voltage(V)						
Dissipation Factor (tan δ) (+20°C, at 120Hz)	Less than the value under table (%)						
	Cap (μ F) / W.V.(V)	16	25~35	50~63	80~100	160~250	315~450
	47~390	-	-	-	15	15	20
	470~3900	-	20	20	20	15	20
	4700~8200	35	30	30	25	-	-
	10000~22000	40	35	30	-	-	-
Low Temperature Characteristics (120Hz)	Impedance ratio max						
	Working voltage(VDC)	16	25~100	160~250	315~450		
	Z-25°C / Z+20°C	5	4	4	8		
Z-40°C/Z+20°C	20	20	-	-			
Endurance	Test condition Duration time :3000Hrs Ambient temperature :+105°C Applied voltage :Rated DC working voltage After test requirement at +20°C Capacitance change : ≤ ±20% of the initial measured value Dissipation factor : ≤ 200% of the initial specified value Leakage current : ≤ The initial specified value						
Shelf Life	Test condition Duration time :1000Hrs Ambient temperature :+105°C Applied voltage :None After test requirement at +20°C:Same limits as Endurance. Pre-treatment for measurements shall be conducted after application of DC working voltage for 30 minutes.						

Multiplier for Ripple Current vs. Frequency

CAP (μF) \ Hz	50(60)	120	1K	10K	50K-100K
10<CAP≤100	0.8	1	1.36	1.48	1.53
100<CAP≤1000	0.8	1	1.25	1.35	1.38
1000<CAP	0.8	1	1.17	1.25	1.28

Diagram of Dimensions:(unit:mm)

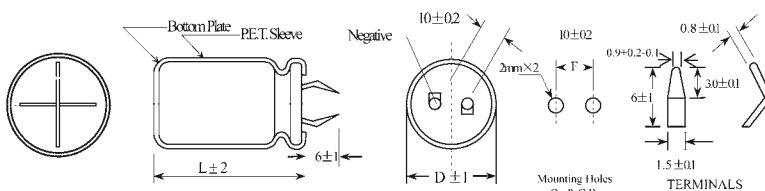

Safety Device

Case Size

φ DxL(mm)

WV (V) Cap(uF)	16V		25V		35V		50V		63V		
	Size	Ripple	Size	Ripple	Size	Ripple	Size	Ripple	Size	Ripple	
1200									22x26	1.25	
1500									22x31	1.47	
1800								22x26	1.34	22x31	1.58
2200								22x31	1.50	22x36	1.82
2700								22x31	1.70	22x41	2.07
3300					22x26	1.45	22x36	1.98	22x46	2.33	
3900					22x31	1.69	22x41	2.25	25x36	2.27	
4700			22x26	1.61	22x36	2.02	22x46	2.56	25x36	2.24	
5600			22x31	1.80	25x31	2.04	25x41	2.81	25x41	2.54	
6800	22x26	1.75	22x31	1.91	22x41	2.41	25x46	3.37	25x31	2.28	
8200	22x31	2.00	22x36	2.14	25x36	2.31	25x46	3.39	30x26	2.22	
10000	25x26	2.05	25x31	2.34	25x36	2.31	25x46	3.31	30x31	2.22	
12000	22x31	2.10	25x36	2.61	25x41	2.73	25x46	3.31	30x31	2.22	
15000	25x26	2.05	30x26	2.25	25x41	2.73	25x46	3.31	30x31	2.22	
18000	22x31	2.10	30x31	2.61	25x46	3.05	25x46	3.31	30x31	2.22	
22000	25x26	2.05	22x46	2.69	25x46	3.05	25x46	3.31	30x31	2.22	
27000	22x31	2.10	25x41	2.81	25x46	3.05	25x46	3.31	30x31	2.22	
33000	25x26	2.05	25x41	2.81	25x46	3.05	25x46	3.31	30x31	2.22	
39000	22x31	2.10	25x41	2.81	25x46	3.05	25x46	3.31	30x31	2.22	
47000	25x26	2.05	25x41	2.81	25x46	3.05	25x46	3.31	30x31	2.22	

Ripple Current(A rms) at 105°C /120Hz

φ DxL(mm)

WV (V) Cap(μF)	80V		100V		160V		200V		220V	
	Size	Ripple	Size	Ripple	Size	Ripple	Size	Ripple	Size	Ripple
220							22x26	1.05	22x26	1.10
270									22x31	1.15
330							22x31	1.25	22x36	1.25
							25x26	1.25	25x26	1.25
390					22x26	1.30	22x31	1.35	22x36	1.40
							25x26	1.35	25x31	1.40
470					22x31	1.55	22x36	1.50	22x41	1.45
					25x26	1.55	25x31	1.50	25x36	1.45
560			22x26	1.07	22x36	1.67	22x41	1.67	22x46	1.70
					25x31	1.67	25x31	1.67	25x41	1.70
					30x26	1.67	30x26	1.67	30x31	1.70
			22x31	1.22	22x41	1.82	22x46	1.78	25x46	1.78
680			25x26	1.22	25x31	1.82	25x36	1.78	30x36	1.78
					30x26	1.82	30x31	1.78	35x27	1.78
							35x27	1.78		
820	22x26	1.11	22x31	1.35	22x46	2.04	22x51	2.04	25x51	2.10
			25x26	1.35	25x36	2.04	25x46	2.04	30x41	2.10
					30x31	2.04	30x31	2.04	35x32	2.10
					35x27	2.04	35x27	2.04		
1000	22x26	1.29	22x31	1.54	22x51	2.25	25x51	2.30	30x46	2.40
			25x31	1.56	25x41	2.25	30x36	2.30	35x37	2.40
					30x31	2.25	35x32	2.30		
					35x27	2.25				
1200	22x31	1.44	22x41	1.74	25x46	2.49	30x41	2.65	30x51	2.60
	25x26	1.39	25x31	1.76	30x36	2.49	35x32	2.65	35x42	2.60
			30x26	1.71	35x32	2.49				
1500	22x31	1.61	22x46	1.99	30x41	2.84	30x51	3.08	35x47	3.00
	25x26	1.62	25x36	2.03	35x32	2.84	35x42	3.08		
			30x31	2.00						
1800	22x36	1.83	25x41	2.28	30x46	3.32	35x47	3.48		
	25x31	1.86	30x36	2.27	35x37	3.00				
	30x26	1.81								
2200	22x41	2.09	25x51	2.57	35x47	3.50	35x52	3.78		
	25x36	2.01	30x36	2.59						
	30x26	2.10	35x32	2.52						
2700	25x41	2.43	30x46	2.94	35x52	4.00				
	30x31	2.43	35x37	2.90						
3300	25x46	2.76	30x51	3.32						
	30x36	2.78	35x42	3.31						
	35x32	2.71								
3900	25x51	2.92	35x47	3.69						
	30x41	3.12								
	35x32	3.07								
4700	30x46	3.52	35x52	4.14						
	35x37	3.50								
5600	30x51	3.80								
	35x42	3.87								
6800	35x47	4.19								

Ripple Current(A rms) at 105°C /120Hz

φ DxL(mm)

WV (V) Cap(μF)	250V		315V		400V		420V		450V	
	Size	Ripple	Size	Ripple	Size	Ripple	Size	Ripple	Size	Ripple
68					22x26	0.55			22x26	0.52
82					22x26	0.64	22x26	0.64	22x31	0.64
									25x26	0.64
100					22x31	0.70	22x31	0.70	22x36	0.69
					25x26	0.70	25x26	0.70	25x31	0.69
120			22x26	0.75	22x36	0.75	22x36	0.75	22x41	0.80
					25x26	0.75	25x31	0.75	25x31	0.80
									30x26	0.80
150			22x31	0.82	22x41	0.88	22x41	0.88	22x46	0.88
			25x26	0.82	25x26	0.83	25x36	0.88	25x36	0.88
					25x31	0.88	30x26	0.88	30x31	0.88
					30x26	0.88				
180			22x36	0.92	22x46	0.98	22x46	0.95	22x51	1.00
			25x26	0.92	25x36	0.98	25x36	0.95	25x41	1.00
					30x31	0.98	30x31	0.95	30x31	1.00
					35x27	0.98				
220	22x26	1.10	22x41	1.04	22x51	1.10	22x51	1.10	22x51	1.00
	22x26	1.10	25x31	1.04	25x41	1.10	25x46	1.10	25x46	1.12
			30x26	1.04	30x31	1.10	30x36	1.10	30x36	1.12
					35x27	1.10	35x27	1.10	35x32	1.12
270	22x36	1.18	22x46	1.16	22x51	1.19	25x51	1.22	30x41	1.28
	25x26	1.18	25x36	1.16	25x46	1.22	30x41	1.22	35x37	1.28
			30x26	1.16	30x36	1.22	35x32	1.22		
					35x35	1.22				
330	22x41	1.30	22x51	1.33	22x61	1.45	30x46	1.45	30x51	1.45
	25x31	1.30	25x41	1.33	25x51	1.44	30x51	1.52	35x42	1.45
	30x26	1.30	30x31	1.33	30x41	1.44	35x37	1.45		
			35x27	1.33	35x32	1.44				
390	22x46	1.49	25x46	1.47	30x46	1.60	30x51	1.55	35x42	1.50
	25x36	1.49	30x36	1.47	35x37	1.60	35x42	1.55		
	30x26	1.49	35x32	1.47						
470	22x51	1.65	25x51	1.70	30x51	1.90	35x47	1.90	35x52	1.85
	25x41	1.65	30x41	1.70	35x42	1.90				
	30x31	1.65	35x32	1.70	35x47	2.10				
	35x27	1.65								
560	25x46	1.80	30x46	2.05	35x47	2.12	35x47	2.10	35x57	2.15
	30x36	1.80	35x37	2.05			35x52	2.15		
	35x27	1.80								
680	25x51	2.00	30x51	2.17	35x57	2.35	35x57	2.35	35x57	2.20
	30x41	2.00	35x42	2.17					35x62	2.30
	35x32	2.00								
820	30x46	2.30	35x47	2.20	35x57	2.50				
	35x37	2.30								
1000	30x51	2.47			35x80	2.65				
	35x42	2.47								
1200	35x47	2.60			35x80	2.75				
1500	35x52	3.00								

Ripple Current(A rms) at 105°C /120Hz

HL Series Low ESR, Snap-in Type

Features

- ◆ Highly reliable capacitors that withstand low ESR & long life.
- ◆ Two or three dimensions with same ratings.
- ◆ RoHS Compliant



Specifications

Item	Performance Characteristics											
Operating Temperature Range	-40 to +105°C	-25 to +105°C										
Rated Voltage Range	10 to 100 VDC	160 to 400 VDC										
Capacitance Range	560 to 47000 µF	56 to 1500 µF										
Capacitance Tolerance	±20% (120Hz, +20°C)											
Leakage Current (+20°C, max.)	I ≤ 0.02CV After 5 minutes with rated working voltage applied.											
Dissipation Factor (tan δ, at 20°C, 120Hz)	Less than the value under table (%)											
	Working Voltage(VDC)	10	16	25	35	50	63	80	100	160 ~ 250	350 ~ 400	
Low Temperature Characteristics (at 120Hz)	D.F. (%) max.	55	40	30	25	20	15	15	15	15	15	
	Impedance ratio max.											
	Working voltage (VDC)	10, 16	25	35	50, 63	80, 100	160 to 400					
Endurance	Z -25°C / Z +20°C	4	3	3	2	2	4					
	Z -40°C / Z +20°C	15	10	8	6	5	—					
	Test conditions Duration time :5000 Hrs Ambient temperature :+105°C Applied voltage :Rated DC working voltage											
Shelf Life	After test requirement at +20°C Capacitance change :≤ ±25% of the initial measured value Dissipation factor :≤ 250% of the initial specified value Leakage current :≤ The initial specified value											
	Test conditions Duration time :1000 Hrs Ambient temperature :+105°C Applied voltage :None											
	After test requirement at +20°C : The same limits as Endurance. Pre-treatment for measurements shall be conducted after application of DC working voltage for 30 minutes.											

Multiplier for Ripple Current vs. Frequency

VDC \ Frequency(Hz)	50	120	300	1K	10K	50K
10~50 WV	0.95	1	1.03	1.05	1.08	1.08
63~100 WV	0.93	1	1.07	1.13	1.19	1.20
160,250 WV	0.81	1	1.17	1.32	1.45	1.50
350,400 WV	0.77	1	1.16	1.30	1.41	1.43

Diagram of Dimensions:(unit:mm)

SYMBOL G : P.C.B. TERMINAL (SNAP-IN)

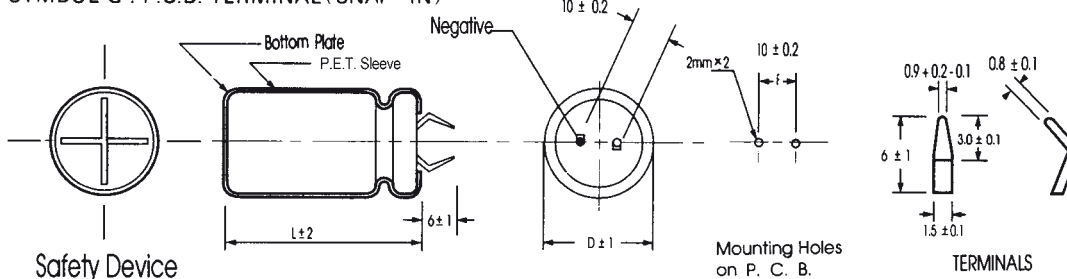

Case Size

φ D x L (mm)

Cap (μF)	φ D	10											
		22			25			30			35		
		Size	Ripple	ESR	Size	Ripple	ESR	Size	Ripple	ESR	Size	Ripple	ESR
5600	22x26	1.1	50										
6800	22x26	1.3	41	25x26	1.3	41							
8200	22x26	1.56	34	25x26	1.56	34							
10000	22x31	1.6	32	25x26	1.6	32	30x26	1.6	32				
12000	22x36	1.8	27	25x31	1.8	27	30x26	1.8	27				
15000	22x36	2.1	21	25x31	2.1	21	30x26	2.1	21				
18000	22x36	2.2	18	25x31	2.2	18	30x31	2.2	18				
22000	22x41	2.75	14	25x36	2.75	14	30x31	2.75	14	35x27	2.75	14	
27000				25x51	3.05	13	30x41	3.05	13	35x32	3.05	13	
33000				25x51	3.4	11	30x41	3.4	11	35x37	3.4	11	
39000							30x51	3.6	9	35x41	3.6	9	
47000							30x51	4.6	8	35x52	4.6	8	

Cap (μF)	φ D	16											
		22			25			30			35		
		Size	Ripple	ESR	Size	Ripple	ESR	Size	Ripple	ESR	Size	Ripple	ESR
5600	22x26	1.4	50										
6800	22x31	1.6	41	25x26	1.6	41							
8200	22x36	1.8	34	25x31	1.8	34							
10000	22x41	2.1	32	25x31	2.1	32	30x26	2.1	32				
12000	22x41	2.4	27	25x36	2.4	27	30x26	2.4	27				
15000	22x51	2.7	21	25x41	2.7	21	30x31	2.7	21				
18000				25x51	3.05	18	30x36	3.05	18	35x32	3.05	18	
22000				25x51	3.4	14	30x41	3.4	14	35x47	3.4	14	
27000							30x51	4.02	13	35x42	4.02	13	
33000							30x51	4.32	11	35x42	4.32	11	
39000										35x52	4.95	9	

Cap (μF)	φ D	25											
		22			25			30			35		
		Size	Ripple	ESR	Size	Ripple	ESR	Size	Ripple	ESR	Size	Ripple	ESR
3900	22x26	1.3	51										
4700	22x31	1.5	51	25x26	1.5	51							
5600	22x36	1.6	43	25x26	1.6	43							
6800	22x41	1.87	35	25x31	1.87	35	30x26	1.87	35				
8200	22x46	2.2	29	25x36	2.2	29	30x31	2.2	29	35x27	2.2	29	
10000	22x51	2.35	28	25x41	2.35	28	30x36	2.35	28	35x32	2.35	28	
12000				25x51	2.7	23	30x36	2.7	23	35x32	2.7	23	
15000							30x41	3.15	19	35x37	3.15	19	
18000							30x51	3.6	15	35x42	3.6	15	
22000										35x47	3.9	13	
27000										35x52	4.6	12	

Cap (μF)	φ D	35											
		22			25			30			35		
		Size	Ripple	ESR	Size	Ripple	ESR	Size	Ripple	ESR	Size	Ripple	ESR
2200	22x26	1.1	90										
2700	22x26	1.29	74										
3300	22x31	1.4	60	25x26	1.4	60							
3900	22x36	1.55	51	25x31	1.55	51							
4700	22x41	1.75	42	25x31	1.75	42	30x26	1.75	42				
5600	22x46	1.95	36	25x36	1.95	36	30x31	1.95	36	35x27	1.95	36	
6800	22x51	2.2	29	25x41	2.2	29	30x36	2.2	29	35x32	2.2	29	
8200				25x51	2.5	24	30x36	2.5	24	35x32	2.5	24	
10000							30x41	2.8	24	35x37	2.8	24	
12000							30x51	3.3	20	35x42	3.3	20	
15000										35x52	4.25	16	

Ripple Current (A, rms) at 105°C 120Hz
Max ESR (mΩ) at 20°C 30KHz

Snap-in

φ D x L (mm)

Cap (μF) / φ D	50											
	22			25			30			35		
	Size	Ripple	ESR	Size	Ripple	ESR	Size	Ripple	ESR	Size	Ripple	ESR
1500	22x26	1	80									
1800	22x31	1.1	66	25x26	1.1	66						
2200	22x36	1.3	54	25x26	1.3	54						
2700	22x41	1.45	44	25x31	1.45	44	30x26	1.45	44			
3300	22x41	1.7	36	25x36	1.7	36	30x31	1.7	36			
3900	22x51	1.9	31	25x41	1.9	31	30x36	1.9	31			
4700				25x41	2.1	25	30x36	2.1	25	35x32	2.1	25
5600				25x51	2.36	21	30x41	2.36	21	35x37	2.36	21
6800							30x51	2.7	18	35x42	2.7	18
8200							30x51	3.16	15	35x42	3.16	15
10000										35x52	3.5	16

Cap (μF) / φ D	63											
	22			25			30			35		
	Size	Ripple	ESR	Size	Ripple	ESR	Size	Ripple	ESR	Size	Ripple	ESR
1000	22x26	1	100									
1200	22x26	1.15	86	25x26	1.15	86						
1500	22x36	1.3	69	25x31	1.3	69						
1800	22x41	1.45	58	25x31	1.45	58	30x26	1.45	58			
2200	22x46	1.65	47	25x36	1.65	47	30x31	1.65	47	35x27	1.65	47
2700	22x51	1.9	38	25x41	1.9	38	30x36	1.9	38	35x32	1.9	38
3300				25x51	2.15	31	30x36	2.15	31	35x32	2.15	31
3900							30x41	2.4	27	35x37	2.4	27
4700							30x51	2.7	22	35x42	2.7	22
5600							30x51	3.1	18	35x42	3.1	18
6800										35x52	3.5	15

Cap (μF) / φ D	80											
	22			25			30			35		
	Size	Ripple	ESR	Size	Ripple	ESR	Size	Ripple	ESR	Size	Ripple	ESR
680	22x26	0.95	140									
820	22x31	1	120									
1000	22x36	1.2	96	25x26	1.2	96						
1200	22x41	1.4	80	25x31	1.4	80						
1500	22x46	1.6	64	25x36	1.6	64	30x26	1.6	64			
1800	22x51	1.8	53	25x41	1.8	53	30x31	1.8	53	35x27	1.8	53
2200				25x51	2.05	43	30x36	2.05	43	35x32	2.05	43
2700							30x41	2.35	35	35x37	2.35	35
3300							30x51	2.7	29	35x42	2.7	29
3900										35x47	2.8	24
4700										35x52	3.4	20

Cap (μF) / φ D	100											
	22			25			30			35		
	Size	Ripple	ESR	Size	Ripple	ESR	Size	Ripple	ESR	Size	Ripple	ESR
560	22x31	0.95	170	25x26	0.95	170						
680	22x36	1.1	140	25x31	1.1	140						
820	22x41	1.4	120	25x31	1.4	120	30x26	1.4	120			
1000	22x46	1.4	96	25x36	1.4	96	30x31	1.4	96	35x27	1.4	96
1200	22x51	1.6	80	25x41	1.6	80	30x36	1.6	80	35x32	1.6	80
1500				25x51	1.85	64	30x41	1.85	64	35x32	1.85	64
1800							30x46	2.05	53	35x37	2.05	53
2200							30x51	2.4	43	35x42	2.4	43
2700										35x52	2.8	35

Ripple Current (A, rms) at 105°C 120Hz
Max ESR (mΩ) at 20°C 30KHz

φ DxL(mm)

Cap (μF)	φ D	160											
		22			25			30			35		
		Size	Ripple	ESR	Size	Ripple	ESR	Size	Ripple	ESR	Size	Ripple	ESR
270		22x31	0.6	320									
330		22x36	0.8	270	25x26	0.8	270						
390		22x36	0.85	220	25x31	0.85	220						
470		22x46	1.1	190	25x36	1.1	190	30x31	1.1	190			
560		22x46	1.16	160	25x36	1.16	160	30x31	1.16	160			
680					25x46	1.3	130	30x36	1.3	130			
820					25x46	1.43	110	30x41	1.43	110	35x32	1.43	110
1000								30x46	1.69	88	35x37	1.69	88
1200											35x47	1.95	73
1500											35x52	2.4	58

Cap (μF)	φ D	200											
		22			25			30			35		
		Size	Ripple	ESR	Size	Ripple	ESR	Size	Ripple	ESR	Size	Ripple	ESR
180		22x26	0.57	490									
220		22x31	0.65	400									
270		22x36	0.78	320	25x26	0.78	320						
330		22x41	0.9	270	25x31	0.9	270						
390		22x41	0.98	220	25x36	0.98	220	30x26	0.98	220			
470		22x41	1.15	190	25x36	1.15	190	30x26	1.15	190			
560		22x46	1.3	160	25x36	1.3	160	30x26	1.3	160			
680		22x51	1.45	130	25x41	1.45	130	30x31	1.45	130	35x27	1.45	130
820					25x46	1.6	110	30x36	1.6	110	35x37	1.77	110
1000					25x56	1.9	88	30x46	1.9	88	35x37	1.9	88
1200								30x51	2.1	73	35x42	2.1	73

Cap (μF)	φ D	250											
		22			25			30			35		
		Size	Ripple	ESR	Size	Ripple	ESR	Size	Ripple	ESR	Size	Ripple	ESR
150		22x26	0.52	580									
180		22x31	0.64	490	25x26	0.64	490						
220		22x36	0.75	400	25x31	0.75	400						
270		22x41	0.85	320	25x31	0.85	320	30x26	0.85	320			
330		22x46	1	270	25x36	1	270	30x31	1	270	35x27	1	270
390		22x51	1.1	220	25x41	1.1	220	30x36	1.1	220			
470					25x51	1.2	190	30x36	1.2	190	35x32	1.2	190
560								30x41	1.35	160	35x37	1.35	160
680								30x51	1.55	130	35x42	1.55	130
820								30x56	1.7	110			
1000											35x52	2	88

Cap (μF)	φ D	350											
		22			25			30			35		
		Size	Ripple	ESR	Size	Ripple	ESR	Size	Ripple	ESR	Size	Ripple	ESR
68		22x26	0.34	1290									
82		22x31	0.4	1070									
100		22x36	0.5	880	25x26	0.5	880						
120		22x41	0.56	730	25x31	0.56	730	30x26	0.56	730			
150		22x46	0.63	580	25x36	0.63	580	30x31	0.63	580			
180		22x51	0.7	490	25x41	0.7	490	30x31	0.7	490			
220					25x51	0.82	400	30x36	0.82	400	35x32	0.82	400
270								30x41	0.9	320	35x37	0.9	320
330								30x51	1.1	270	35x42	1.1	270
390											35x47	1.2	220
470											35x52	1.3	190

Ripple Current (A, rms) at 105°C 120Hz
Max ESR (mΩ) at 20°C 30KHz

Cap (μ F)	ϕ D	400											ϕ DxL (mm)	
		22			25			30			35			
		Size	Ripple	ESR	Size	Ripple	ESR	Size	Ripple	ESR	Size	Ripple		ESR
56		22x26	0.32	1560										
68		22x31	0.4	1290	25x26	0.4	1290							
82		22x36	0.45	1070	25x31	0.45	1070							
100		22x41	0.5	880	25x31	0.5	880	30x26	0.5	880				
120		22x41	0.55	730	25x36	0.55	730	30x31	0.55	730				
150		22x51	0.65	580	25x41	0.65	580	30x36	0.65	580				
180					25x46	0.75	490	30x36	0.75	490	35x32	0.75	490	
220					25x51	0.85	400	30x41	0.85	400	35x37	0.85	400	
270								30x51	1.05	320	35x42	1.05	320	
330											35x47	1.1	270	
390											35x52	1.2	220	

Ripple Current (A, rms) at 105°C 120Hz

Max ESR (m Ω) at 20°C 30KHz

LT Series 4 Terminals Snap-in Type 85°C

Features

- ◆ Highly capacitors values and compact size.
- ◆ Two vent construction.
- ◆ 4 snap-in terminals for printed circuit board mounting.
- ◆ RoHS Compliant



Specifications

Item	Performance Characteristics									
Operating Temperature Range	-40 to 85 °C	-25 ~ +85°C								
Rated Voltage Range	16 ~ 100 VDC	160 ~ 450 VDC								
Capacitance Range	4700 ~ 82000 µ F	330 ~ 3300 µ F								
Capacitance Tolerance	± 20% (120Hz, +20°C)									
Leakage Current (+20°C, max.)	I ≤ 0.02 CV (µ A) After 5 minutes with rated working voltage applied.									
Dissipation Factor (tan δ , at 20°C , 120Hz)	Less than the value under table (%)									
	φ /VDC	16	25	35	50	63	80	100	160 ~ 250	350 ~ 450
	φ 35 D.F. (%) max.	45	40	35	30	25	25	20	15	20
	φ 40 D.F. (%) max.	50	45	40	35	30	25	20	15	20
Low Temperature Characteristics (at 120Hz)	Impedance ratio max.									
	Working voltage (VDC)	16	25	35 ~ 100	160 ~ 250	400 ~ 450				
	Z-25°C / Z+20°C	5	3	3	7	15				
Endurance	Test conditions									
	Duration time	:2000 Hrs								
	Ambient temperature	:+85°C								
	Applied voltage	:Rated DC working voltage								
	After test requirement at +20°C									
	Capacitance change	:≤ ±20% of the initial measured value								
	Dissipation factor	:≤ 175% of the initial specified value								
	Leakage current	:≤ The initial specified value								
Shelf Life	Test conditions									
	Duration time	:1000 Hrs								
	Ambient temperature	:+85°C								
	Applied voltage	:None								
	After test requirement at +20°C : Same limits as Endurance.									
	Pre-treatment for measurements shall be conducted after application of DC working voltage for 30 minutes.									

Multiplier for Ripple Current vs. Frequency

CAP (µ F) \ Frequency(Hz)	50(60)	120	400	1K	10K	50K-100K
10 < CAP ≤ 100	0.8	1	1.23	1.36	1.48	1.53
100 < CAP ≤ 1000	0.8	1	1.16	1.25	1.35	1.38
1000 < CAP	0.8	1	1.11	1.17	1.25	1.28

Diagram of Dimensions:(unit:mm)

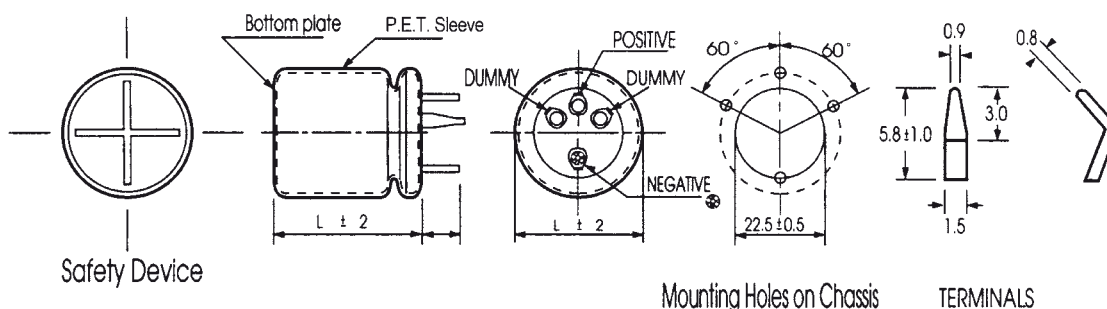

Case Size

WV φ D		16				25			
		35		40		35		40	
		Size	Ripple	Size	Ripple	Size	Ripple	Size	Ripple
Cap(μ F)									
33000					35x52	5.76			
39000					35x63	6.24	40x52	6.24	
47000	35x32	5.88			35x83	7.08	40x63	7.08	
56000	35x63	6.48	40x52	6.48			40x83	7.40	
68000	35x83	7.20	40x63	7.20			40x83	8.55	
82000			40x83	8.16					

WV φ D		35				50			
		35		40		35		40	
		Size	Ripple	Size	Ripple	Size	Ripple	Size	Ripple
Cap(μ F)									
15000					35x52	4.53			
18000					35x63	5.07	40x52	5.07	
22000	35x52	4.98			35x83	5.74	40x63	5.74	
27000	35x63	5.82					40x63	6.16	
33000	35x83	6.00	40x63	6.38					
39000	35x83	6.91	40x63	7.00					
47000			40x83	7.52					

WV φ D		63				80			
		35		40		35		40	
		Size	Ripple	Size	Ripple	Size	Ripple	Size	Ripple
Cap(μ F)									
4700					35x52	3.20			
6800					35x52	3.62			
8200					35x63	3.92	40x52	3.92	
10000					35x83	4.42	40x63	4.42	
12000	35x63	4.65	40x52	4.80			40x83	5.10	
15000	35x83	4.90	40x63	5.00			40x83	5.58	
18000	35x83	5.86							
22000			40x83	6.00					

WV φ D		100				160			
		35		40		35		40	
		Size	Ripple	Size	Ripple	Size	Ripple	Size	Ripple
Cap(μ F)									
1800					35x52	2.46			
2200					35x63	2.77	40x52	2.77	
2700					35x83	3.00	40x63	3.00	
3300							40x83	3.26	
5600	35x63	3.64	40x52	3.64					
6800	35x83	3.94	40x63	3.94					
8200			40x83	4.47					

WV φ D		220				250			
		35		40		35		40	
		Size	Ripple	Size	Ripple	Size	Ripple	Size	Ripple
Cap(μ F)									
390					35x52	1.18			
1000	35x52	2.02			35x63	2.10			
1200	35x52	2.24			35x63	2.24	40x52	2.24	
1500	35x63	2.44			35x83	2.37	40x63	2.37	
1800	35x83	2.65	40x63	2.65			40x83	2.79	
2700			40x83	3.03					

WV φ D		400				450			
		35		40		35		40	
		Size	Ripple	Size	Ripple	Size	Ripple	Size	Ripple
Cap(μ F)									
330					35x52	1.16			
390					35x63	1.22			
470	35x63	1.36			35x83	1.38	40x52	1.38	
560	35x83	1.44	40x52	1.44	35x83	1.50	40x63	1.50	
680	35x83	1.59	40x63	1.59			40x83	1.64	
820			40x83	1.78					

Ripple Current (A, rms) at 85°C 120Hz

HT Series 4 Terminals Snap-in Type 105°C

Features

- ◆ Premium industrial grade.
- ◆ Long life 2000 Hrs at +105°C with ripple current applied.
- ◆ Expected life : 75000 hrs at +65°C with ripple current applied.
- ◆ Various case sizes and vent construction.
- ◆ RoHS Compliant



Specifications

Item	Performance Characteristics									
Operating Temperature Range	-25 to +105°C									
Rated Voltage Range	160 ~ 400 VDC									
Capacitance Range	82 ~ 1200 µ F									
Capacitance Tolerance	±20% (120Hz, +20°C)									
Leakage Current (+20°C,max.)	$I \leq 0.02CV$ After 5 minutes with rated working voltage applied.									
Dissipation Factor (tan δ , at 20°C , 120Hz)	15% max.									
Low Temperature Characteristics (at 120Hz)	Impedance ratio max									
	<table border="1"> <thead> <tr> <th>Working voltage (VDC)</th> <th>160</th> <th>200</th> <th>250</th> <th>400</th> </tr> </thead> <tbody> <tr> <td>Z -25°C / Z +20°C</td> <td>4</td> <td>4</td> <td>4</td> <td>8</td> </tr> </tbody> </table>	Working voltage (VDC)	160	200	250	400	Z -25°C / Z +20°C	4	4	4
Working voltage (VDC)	160	200	250	400						
Z -25°C / Z +20°C	4	4	4	8						
Endurance	Test conditions Duration time :2000 Hrs Ambient temperature :+105°C Applied voltage :Rated DC working voltage After test requirement at +20°C Capacitance change :≤ ±20% of the initial measured value Dissipation factor :≤ 200% of the initial specified value Leakage current :≤ The initial specified value									
Shelf Life	Test conditions Duration time :1000 Hrs Ambient temperature :+105°C Applied voltage :None After test requirement at +20°C : Same limits as Endurance. Pre-treatment for measurements shall be conducted after application of DC working voltage for 30 minutes.									

Snap-in

Multiplier for Ripple Current vs. Frequency

CAP(µ F)\Frequency(Hz)	50(60)	120	400	1K	10K	50K-100K
10 < CAP ≤ 100	0.8	1	1.23	1.36	1.48	1.53
100 < CAP ≤ 1000	0.8	1	1.16	1.25	1.35	1.38
1000 < CAP	0.8	1	1.11	1.17	1.25	1.28

Diagram of Dimensions:(unit:mm)

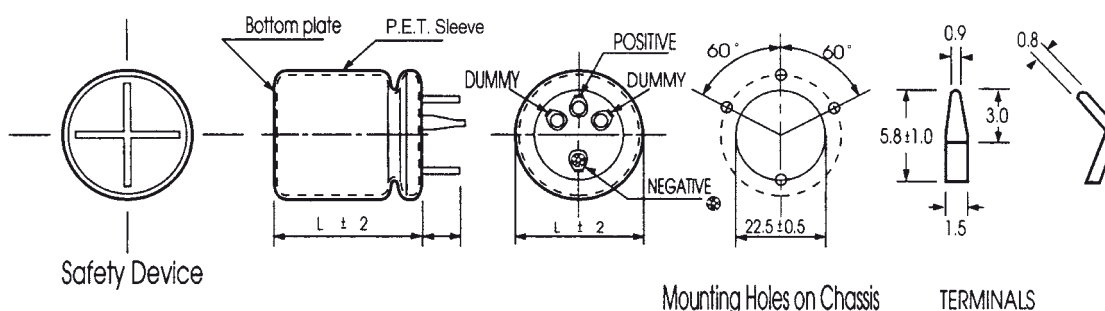

Case Size

φ DxL(mm)

Cap(μF)	WV	φ D	160				200			
			30		35		30		35	
			Size	Ripple	Size	Ripple	Size	Ripple	Size	Ripple
220						30x26	1.15			
270						30x26	1.22			
330			30x26	1.39			30x31	1.33		
390			30x26	1.47			30x31	1.47	35x27	
470			30x31	1.64			30x36	1.54	35x32	
560			30x31	1.76			30x41	1.69	35x32	
680			30x36	1.98	35x32	1.98	30x46	1.90	35x37	
820			30x41	2.36	35x32	2.36	30x51	2.24	35x42	
1000			30x51	2.60	35x37	2.60				
1200			30x56	2.73						

Cap(μF)	WV	φ D	250				400			
			30		35		30		35	
			Size	Ripple	Size	Ripple	Size	Ripple	Size	Ripple
82						30x26	0.73			
100						30x31	0.82			
120						30x36	0.87	35x27	0.87	
150						30x41	1.00	35x32	1.00	
180			30x26	0.98			30x46	1.06	35x37	
220			30x31	1.10			30x51	1.18	35x42	
270			30x31	1.22						
330			30x36	1.36	35x32	1.36				
390			30x41	1.47	35x32	1.47				
470			30x41	1.58	35x37	1.58				
560			30x51	1.76	35x42	1.76				

Ripple Current (A, rms) at 105°C 120Hz

UB Series 85°C

Features

Standard capacitors

Applications

- ◆ Professional power supplies
- ◆ Frequency converters
- ◆ Uninterruptible power supplies
- ◆ Used for air conditioner, general-purpose inverter

Features

- ◆ High reliability
- ◆ Long useful life
- ◆ High ripple current capability
- ◆ Aluminum case designed explosion-proof vent
- ◆ RoHS-compatible

Construction

- ◆ Charge-discharge proof, polar
- ◆ Aluminum case with insulating sleeve
- ◆ Aluminum case designed explosion-proof vent
- ◆ Snap-in solder pins to hold component in place on PC-board



Specifications

Item	Performance Characteristics		
Operating Temperature Range	-25 to +85°C		
Rated voltage V_R	400, 450 V DC		
Surge voltage V_S	1.10 V_R		
Rated capacitance C_R	330 ~ 1200 μ F		
Capacitance tolerance	$\pm 20\%$ (120Hz, +20°C)		
Dissipation Factor $\tan \delta$ (at 20°C · 120Hz)	Less than the value under table(%)		
	W.V.(V)	400	450
	D.F.(%) max	15	20
Leakage Current I_{leak} (+20°C, max)	$I \leq 3 \sqrt{CV}$ (μ A) After 5 minutes with rated working voltage applied		
Self-inductance ESL	approx. 20 nH		
Useful life 85 °C; $V_R, I_{AC}^2 R$	> 4000 h	Requirements: $\Delta C/C \leq \pm 40\%$ of initial value ESR ≤ 4 times initial specified limit $I_{leak} \leq$ initial specified limit Outlier Percentage: 0 %	
Voltage Endurance test 85 °C; V_R	2000 h	Post test requirements: $\Delta C/C \leq \pm 20\%$ of initial value ESR ≤ 2 times initial specified limit $I_{leak} \leq$ initial specified limit Outlier Percentage: 0 %	
Shelf Life 85 °C	1000 h	Post test requirements: $\Delta C/C \leq \pm 20\%$ of initial value ESR ≤ 2 times initial specified limit $I_{leak} \leq$ initial specified limit Outlier Percentage: 0 %	
Vibration Resistance test	To IEC 60068-2-6, test Fc:		
	Displacement amplitude 0.75 mm, frequency range 10 ... 55 Hz, acceleration max. 10 g, duration 3x2 h. Capacitor mounted by its body which is rigidly clamped to the work surface.		
Characteristics at low temperature	Max. impedance ratio at 120 Hz		
	V_R	≤ 400 V	≥ 450 V
	$Z_{-25^\circ C} / Z_{20^\circ C}$	8	8
Sectional specification	IEC 60384-4 and JIS-C-5101		

Multiplier for Ripple Current vs. Frequency

CAP(μF)/Frequency(Hz)	50(60)	120	400	1K	10K	50K-100K
100≤CAP≤1000	0.8	1	1.16	1.25	1.35	1.38
1000<CAP	0.8	1	1.11	1.17	1.25	1.28

Dimensional drawings

Standard 2 terminals

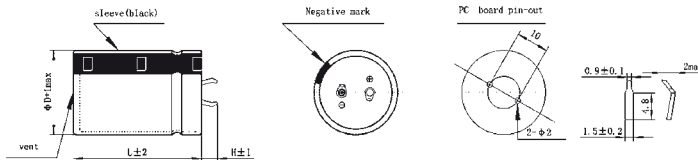

Standard snap-in terminals: length(6.0±1)mm · Also available with length of (4.0±1)mm

Vibration proof terminal T type

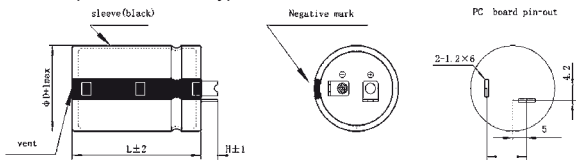

Standard snap-in terminals: length(4.5±1)mm · Also available with length of (5.5±1)mm

Useful life

depending on ambient temperature T_a versus under ripple current operating conditions

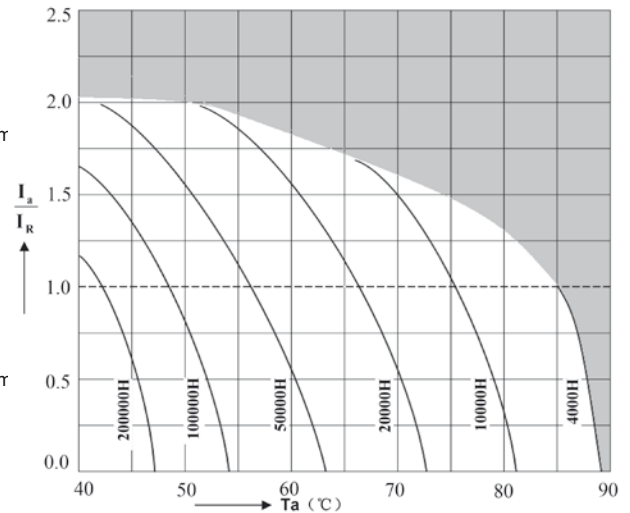

Case Size

WV	400V					450V				
	Size	Ripple	Typ. ESR 20°C 120Hz	MAX ESR 20°C 120Hz	Zmax (mΩ/20°C 10KHz)	Size	Ripple	Typ. ESR 20°C 120Hz	MAX ESR 20°C 120Hz	Zmax (mΩ/20°C 10KHz)
330	30x41	1900	460	640	320	30x46	1650	480	660	340
330	35x37	2000	460	640	320	35x42	1750	480	660	340
390	30x41	2050	390	540	270	35x42	1880	410	560	290
390	30x46	2170	390	540	270	35x47	1970	410	560	290
390	35x37	2170	390	540	270					
470	30x51	2400	320	450	220	35x47	2170	340	470	240
470	35x42	2400	320	450	220	35x52	2250	340	470	240
470	35x47	2500	320	450	220					
560	30x56	2750	270	380	190	35x57	2600	290	400	210
560	35x47	2750	270	380	190	35x62	2680	290	400	210
560	35x52	2900	270	380	190					
680	30x61	3150	220	310	150	35x62	2950	240	330	170
680	35x52	3200	220	310	150	40x62	3170	240	330	170
680	35x57	3300	220	310	150					
820	35x57	3530	190	260	130	40x62	3520	210	280	150
820	35x62	3660	190	260	130					
1000	35x70	3800	150	210	110	40x70	3700	170	230	130
1000	40x62	3820	150	210	110					
1200	40x70	3900	130	180	90					

Ripple Current (m A, rms) at 85°C 120Hz

UC Series 85°C

Features

Long usefull life

Applications

- ◆ Professional power supplies
- ◆ Frequency converters
- ◆ Uninterruptible power supplies
- ◆ Used for air conditioner,general-purpose inverter

Features

- ◆ High reliability
- ◆ Long useful life
- ◆ High ripple current capability
- ◆ Aluminum case designed explosion-proof vent
- ◆ RoHS-compatible

Construction

- ◆ Charge-discharge proof, polar
- ◆ Aluminum case with insulating sleeve
- ◆ Aluminum case designed explosion-proof vent
- ◆ Snap-in solder pins to hold component in place on PC-board



Specifications

Item	Performance Characteristics		
Operating Temperature Range	-25 to +85°C		
Rated voltage V_R	400, 450 V DC		
Surge voltage V_S	1.10 V_R		
Rated capacitance C_R	330 ~ 1200 μ F		
Capacitance tolerance	$\pm 20\%$ (120Hz,+20°C)		
Dissipation Factor $\tan \delta$ (at 20°C · 120Hz)	Less than the value under table(%)		
	W.V.(V)	400	450
	D.F.(%) max	15	20
Leakage Current I_{leak} (+20°C,max)	$I \leq 3 \sqrt{CV}$ (μ A)After 5minutes with rated working voltage applied		
Self-inductance ESL	approx. 20 nH		
Useful life 85 °C; $V_R, I_{AC}^2 R$	> 6000 h	Requirements: $\Delta C/C \leq \pm 40\%$ of initial value ESR ≤ 4 times initial specified limit $I_{leak} \leq$ initial specified limit Outlier Percentage:0 %	
Voltage Endurance test 85 °C; V_R	3000 h	Post test requirements: $\Delta C/C \leq \pm 20\%$ of initial value ESR ≤ 2 times initial specified limit $I_{leak} \leq$ initial specified limit Outlier Percentage:0 %	
Shelf Life 85 °C	1000 h	Post test requirements: $\Delta C/C \leq \pm 20\%$ of initial value ESR ≤ 2 times initial specified limit $I_{leak} \leq$ initial specified limit Outlier Percentage:0 %	
Vibration Resistance test	To IEC 60068-2-6, test Fc:		
	Displacement amplitude 0.75 mm, frequency range 10 ... 55 Hz, acceleration max. 10 g, duration 3x2 h. Capacitor mounted by its body which is rigidly clamped to the work surface.		
Characteristics at low temperature	Max. impedance ratio at 120 Hz		
	V_R	≤ 400 V	≥ 450 V
	$Z_{-25^\circ C} / Z_{20^\circ C}$	8	8
Sectional specification	IEC 60384-4 and JIS-C-5101		

Multiplier for Ripple Current vs. Frequency

CAP(μF)/Frequency(Hz)	50(60)	120	400	1K	10K	50K-100K
100≤CAP≤1000	0.8	1	1.16	1.25	1.35	1.38
1000<CAP	0.8	1	1.11	1.17	1.25	1.28

Dimensional drawings

Standard 2 terminals

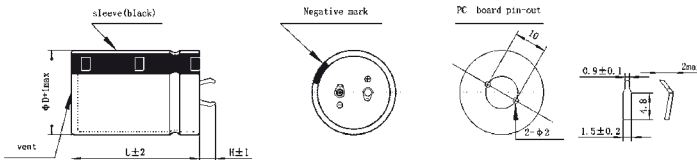

Standard snap-in terminals: length(6.0±1)mm · Also available with length of (4.0±1)mm

Vibration proof terminal T type

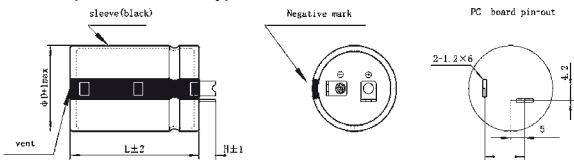

Standard snap-in terminals: length(4.5±1)mm · Also available with length of (5.5±1)mm

Useful life

depending on ambient temperature T_a versus under ripple current operating conditions

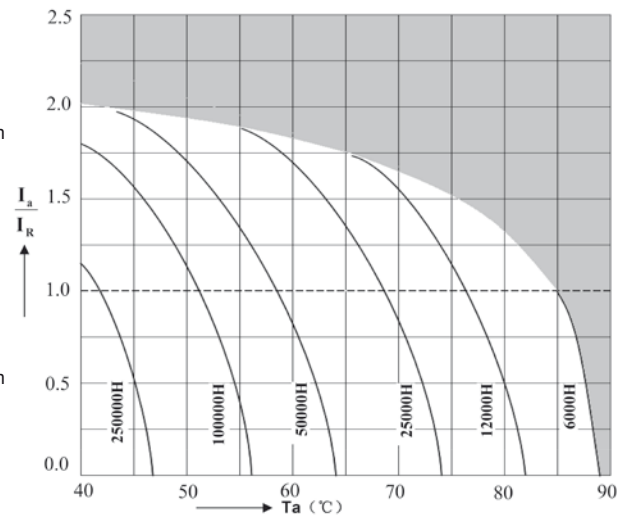

Case Size

WV	Cap(μF)	400V				450V					
		Size	Ripple	Typ. ESR 20°C 120Hz	MAX ESR 20°C 120Hz	Zmax (mΩ/20°C 10KHz)	Size	Ripple	Typ. ESR 20°C 120Hz	MAX ESR 20°C 120Hz	Zmax (mΩ/20°C 10KHz)
	330	30x41	1800	400	560	280	30x46	1580	420	580	300
	330	35x37	1900	400	560	280	35x42	1650	420	580	300
	390	30x41	1960	340	480	240	35x42	1800	360	500	260
	390	30x46	2050	340	480	240	35x47	1900	360	500	260
	390	35x37	2050	340	480	240					
	470	30x51	2370	290	400	200	35x47	2000	310	420	220
	470	35x42	2370	290	400	200	35x52	2200	310	420	220
	470	35x47	2500	290	400	200					
	560	30x56	2700	240	330	170	35x57	2460	260	350	190
	560	35x47	2700	240	330	170	35x62	2560	260	350	190
	560	35x52	2850	240	330	170					
	680	35x52	3130	190	270	130	35x62	2800	210	290	150
	680	35x57	3260	190	270	130	40x62	3000	210	290	150
	820	35x57	3400	160	230	110	40x62	3200	180	250	130
	820	35x62	3540	160	230	110					
	1000	35x70	3760	140	190	90	40x70	3400	160	210	110
	1000	40x62	3830	140	190	90					
	1200	40x70	4000	110	160	80					

Ripple Current (m A, rms) at 85°C 120Hz

UD Series 85°C

Features

Extremely long useful life

Applications

- ◆ Professional power supplies
- ◆ Frequency converters
- ◆ Uninterruptible power supplies
- ◆ Used for air conditioner, general-purpose inverter

Features

- ◆ High reliability
- ◆ Long useful life
- ◆ High ripple current capability
- ◆ Aluminum case designed explosion-proof vent
- ◆ RoHS-compatible

Construction

- ◆ Charge-discharge proof, polar
- ◆ Aluminum case with insulating sleeve
- ◆ Aluminum case designed explosion-proof vent
- ◆ Snap-in solder pins to hold component in place on PC-board



Specifications

Item	Performance Characteristics		
Operating Temperature Range	-25 to +85°C		
Rated voltage V_R	400, 450 V DC		
Surge voltage V_S	1.10 V_R		
Rated capacitance C_R	330 ~ 1200 μ F		
Capacitance tolerance	$\pm 20\%$ (120Hz, +20°C)		
Dissipation Factor $\tan \delta$ (at 20°C · 120Hz)	Less than the value under table(%)		
	W.V.(V)	400	450
D.F.(%) max	15	20	
Leakage Current I_{leak} (+20°C, max)	$I \leq 3 \sqrt{CV}$ (μ A) After 5 minutes with rated working voltage applied		
Self-inductance ESL	approx. 20 nH		
Useful life 85 °C; $V_R, I_{AC}^2 R$	> 10000 h	Requirements: $\Delta C/C \leq \pm 40\%$ of initial value ESR ≤ 4 times initial specified limit $I_{leak} \leq$ initial specified limit Outlier Percentage: 0 %	
Voltage Endurance test 85 °C; V_R	5000 h	Post test requirements: $\Delta C/C \leq \pm 20\%$ of initial value ESR ≤ 2 times initial specified limit $I_{leak} \leq$ initial specified limit Outlier Percentage: 0 %	
Shelf Life 85 °C	1000 h	Post test requirements: $\Delta C/C \leq \pm 20\%$ of initial value ESR ≤ 2 times initial specified limit $I_{leak} \leq$ initial specified limit Outlier Percentage: 0 %	
Vibration Resistance test	To IEC 60068-2-6, test Fc:		
	Displacement amplitude 0.75 mm, frequency range 10 ... 55 Hz, acceleration max. 10 g, duration 3x2 h. Capacitor mounted by its body which is rigidly clamped to the work surface.		
Characteristics at low temperature	Max. impedance ratio at 120 Hz		
	V_R	≤ 400 V	≥ 450 V
$Z_{-25^\circ C} / Z_{20^\circ C}$	8	8	
Sectional specification	IEC 60384-4 and JIS-C-5101		

Multiplier for Ripple Current vs. Frequency

CAP(μF)/Frequency(Hz)	50(60)	120	400	1K	10K	50K-100K
100≤CAP≤1000	0.8	1	1.16	1.25	1.35	1.38
1000<CAP	0.8	1	1.11	1.17	1.25	1.28

Dimensional drawings

Standard 2 terminals

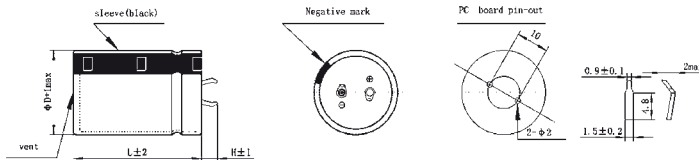

Standard snap-in terminals: length(6.0±1)mm · Also available with length of (4.0±1)mm

Vibration proof terminal T type

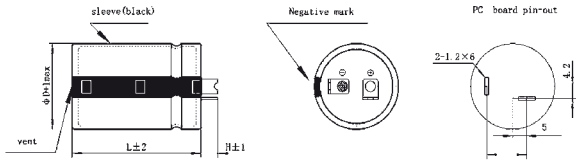

Standard snap-in terminals: length(4.5±1)mm · Also available with length of (5.5±1)mm

Useful life

depending on ambient temperature T_a versus under ripple current operating conditions

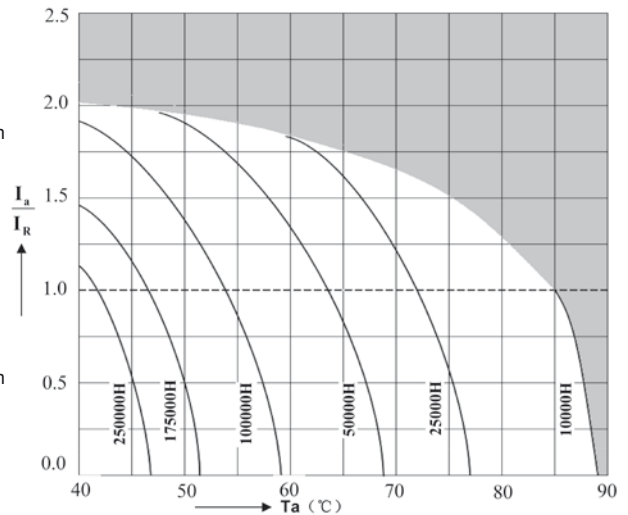

Case Size

WV	400V					450V				
	Size	Ripple	Typ. ESR 20°C 120Hz	MAX ESR 20°C 120Hz	Zmax (mΩ/20°C 10KHz)	Size	Ripple	Typ. ESR 20°C 120Hz	MAX ESR 20°C 120Hz	Zmax (mΩ/20°C 10KHz)
330	30x41	1650	340	480	240	30x46	1460	360	500	260
330	35x37	1700	340	480	240	35x42	1530	360	500	260
390	30x46	1880	290	410	200	35x42	1670	310	430	220
390	35x37	1880	290	410	200	35x47	1750	310	430	220
470	30x51	2160	240	340	170	35x47	1920	260	360	190
470	35x42	2160	240	340	170	35x52	2000	260	360	190
470	35x47	2270	240	340	170					
560	30x56	2350	200	280	140	35x57	2280	220	300	160
560	35x47	2350	200	280	140	35x62	2370	220	300	160
560	35x52	2470	200	280	140					
680	35x52	2700	160	230	110	35x62	2600	180	250	130
680	35x57	2840	160	230	110	40x62	2800	180	250	130
820	35x62	3000	140	190	100	40x62	3000	160	210	120
820	35x67	3200	140	190	100					
820	40x57	3200	140	190	100					
1000	40x62	3680	110	160	80	40x70	3600	90	140	60
1200	40x70	3850	90	130	60					

Ripple Current (m A, rms) at 85°C 120Hz

UJ Series 105°C

Features

Standard capacitors

Applications

- ◆ Professional power supplies
- ◆ Frequency converters
- ◆ Uninterruptible power supplies
- ◆ Used for air conditioner, general-purpose inverter

Features

- ◆ High reliability
- ◆ Long useful life
- ◆ High ripple current capability
- ◆ Aluminum case designed explosion-proof vent
- ◆ RoHS-compatible

Construction

- ◆ Charge-discharge proof, polar
- ◆ Aluminum case with insulating sleeve
- ◆ Aluminum case designed explosion-proof vent
- ◆ Snap-in solder pins to hold component in place on PC-board



Specifications

Item	Performance Characteristics		
Operating Temperature Range	-25 to +105°C		
Rated voltage V_R	400, 450 V DC		
Surge voltage V_S	1.10 V_R		
Rated capacitance C_R	330 ~ 1200 μ F		
Capacitance tolerance	$\pm 20\%$ (120Hz, +20°C)		
Dissipation Factor $\tan \delta$ (at 20°C · 120Hz)	Less than the value under table(%)		
	W.V.(V)	400	450
D.F.(%) max	20	20	
Leakage Current I_{leak} (+20°C, max)	$\leq 3 \sqrt{CV}$ (μ A) After 5 minutes with rated working voltage applied		
Self-inductance ESL	approx. 20 nH		
Useful life 105 °C; $V_R, I_{AC}^2 R$	> 3000 h	Requirements: $\Delta C/C \leq \pm 40\%$ of initial value ESR ≤ 4 times initial specified limit $I_{leak} \leq$ initial specified limit Outlier Percentage: 0 %	
Voltage Endurance test 105 °C; V_R	2000 h	Post test requirements: $\Delta C/C \leq \pm 20\%$ of initial value ESR ≤ 2 times initial specified limit $I_{leak} \leq$ initial specified limit Outlier Percentage: 0 %	
Shelf Life 105 °C	1000 h	Post test requirements: $\Delta C/C \leq \pm 20\%$ of initial value ESR ≤ 2 times initial specified limit $I_{leak} \leq$ initial specified limit Outlier Percentage: 0 %	
Vibration Resistance test	To IEC 60068-2-6, test Fc:		
	Displacement amplitude 0.75 mm, frequency range 10 ... 55 Hz, acceleration max. 10 g, duration 3x2 h. Capacitor mounted by its body which is rigidly clamped to the work surface.		
Characteristics at low temperature	Max. impedance ratio at 120 Hz		
	V_R	≤ 400 V	≥ 450 V
$Z_{-25^\circ C} / Z_{20^\circ C}$	8	8	
Sectional specification	IEC 60384-4 and JIS-C-5101		

Multiplier for Ripple Current vs. Frequency

CAP(μF)/Frequency(Hz)	50(60)	120	400	1K	10K	50K-100K
100≤CAP≤1000	0.8	1	1.16	1.25	1.35	1.38
1000<CAP	0.8	1	1.11	1.17	1.25	1.28

Dimensional drawings

Standard 2 terminals

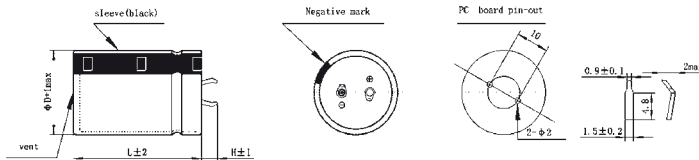

Standard snap-in terminals: length(6.0±1)mm · Also available with length of (4.0±1)mm

Vibration proof terminal T type

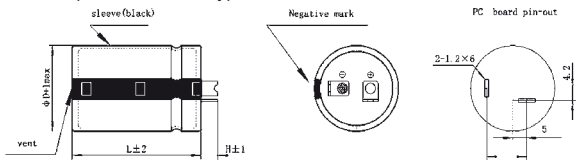

Standard snap-in terminals: length(4.5±1)mm · Also available with length of (5.5±1)mm

Useful life

depending on ambient temperature T_a versus under ripple current operating conditions

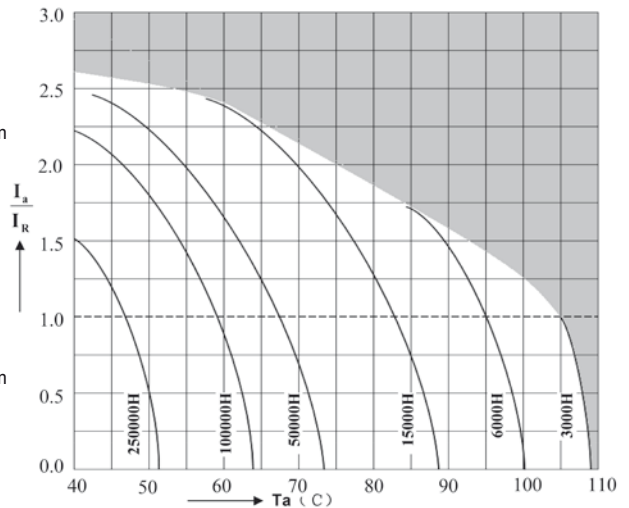

Case Size

WV	400V					450V				
	Size	Ripple	Typ. ESR 20°C 120Hz	MAX ESR 20°C 120Hz	Zmax (mΩ/20°C 10KHz)	Size	Ripple	Typ. ESR 20°C 120Hz	MAX ESR 20°C 120Hz	Zmax (mΩ/20°C 10KHz)
330	30x41	1700	440	610	310	30x46	1580	460	630	330
330	35x37	1780	440	610	310	35x42	1600	460	630	330
390	30x46	1920	360	510	250	35x42	1800	380	530	270
390	35x37	1920	360	510	250	35x47	1880	380	530	270
470	30x51	2180	310	430	220	35x47	2030	330	450	240
470	35x42	2180	310	430	220	35x52	2120	330	450	240
470	35x47	2280	310	430	220					
560	30x56	2500	260	360	180	35x57	2480	280	380	200
560	35x47	2500	260	360	180	35x62	2570	280	380	200
560	35x52	2630	260	360	180					
680	35x52	2800	210	300	150	35x62	2800	230	320	170
680	35x57	2900	210	300	150	40x62	3050	230	320	170
820	35x62	3200	170	240	120	40x62	3400	190	260	140
820	35x67	3300	170	240	120					
820	40x57	3300	170	240	120					
1000	40x62	3600	140	200	100					
1200	40x70	4000	120	170	90					

Ripple Current (m A, rms) at 105°C 120Hz

UK Series 105°C

Features

Long usefull life

Applications

- ◆ Professional power supplies
- ◆ Frequency converters
- ◆ Uninterruptible power supplies
- ◆ Used for air conditioner,general-purpose inverter

Features

- ◆ High reliability
- ◆ Long useful life
- ◆ High ripple current capability
- ◆ Aluminum case designed explosion-proof vent
- ◆ RoHS-compatible

Construction

- ◆ Charge-discharge proof, polar
- ◆ Aluminum case with insulating sleeve
- ◆ Aluminum case designed explosion-proof vent
- ◆ Snap-in solder pins to hold component in place on PC-board



Specifications

Item	Performance Characteristics		
Operating Temperature Range	-25 to +105°C		
Rated voltage V_R	400, 450 V DC		
Surge voltage V_S	1.10 V_R		
Rated capacitance C_R	330 ~ 1200 μ F		
Capacitance tolerance	$\pm 20\%$ (120Hz,+20°C)		
Dissipation Factor $\tan \delta$ (at 20°C · 120Hz)	Less than the value under table(%)		
	W.V.(V)	400	450
D.F.(%) max	20	20	
Leakage Current I_{leak} (+20°C,max)	$I \leq 3 \sqrt{CV}$ (μ A)After 5minutes with rated working voltage applied		
Self-inductance ESL	approx. 20 nH		
Useful life 105 °C; $V_R, I_{AC}^2 R$	> 5000 h	Requirements: $\Delta C/C \leq \pm 40\%$ of initial value ESR ≤ 4 times initial specified limit Ileak \leq initial specified limit Outlier Percentage:0 %	
Voltage Endurance test 105 °C; V_R	3000 h	Post test requirements: $\Delta C/C \leq \pm 20\%$ of initial value ESR ≤ 2 times initial specified limit Ileak \leq initial specified limit Outlier Percentage:0 %	
Shelf Life 105 °C	1000 h	Post test requirements: $\Delta C/C \leq \pm 20\%$ of initial value ESR ≤ 2 times initial specified limit Ileak \leq initial specified limit Outlier Percentage:0 %	
Vibration Resistance test	To IEC 60068-2-6, test Fc:		
	Displacement amplitude 0.75 mm, frequency range 10 ... 55 Hz, acceleration max. 10 g, duration 3x2 h. Capacitor mounted by its body which is rigidly clamped to the work surface.		
Characteristics at low temperature	Max. impedance ratio at 120 Hz		
	V_R	≤ 400 V	≥ 450 V
$Z_{-25^\circ C} / Z_{20^\circ C}$	8	8	
Sectional specification	IEC 60384-4 and JIS-C-5101		

Multiplier for Ripple Current vs. Frequency

CAP(μF)/Frequency(Hz)	50(60)	120	400	1K	10K	50K-100K
100≤CAP≤1000	0.8	1	1.16	1.25	1.35	1.38
1000<CAP	0.8	1	1.11	1.17	1.25	1.28

Dimensional drawings

Standard 2 terminals

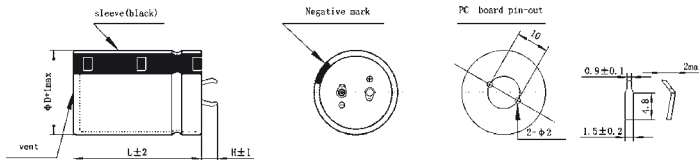

Standard snap-in terminals: length(6.0±1)mm · Also available with length of (4.0±1)mm

Vibration proof terminal T type

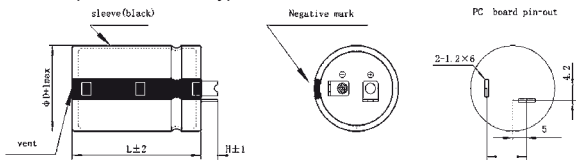

Standard snap-in terminals: length(4.5±1)mm · Also available with length of (5.5±1)mm

Useful life

depending on ambient temperature T_a versus under ripple current operating conditions

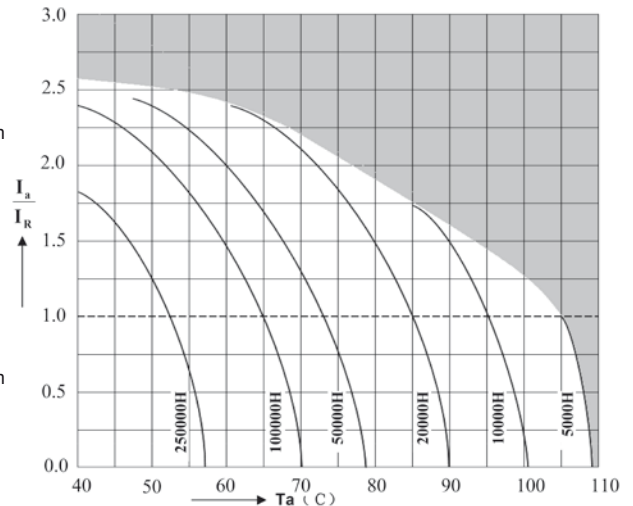

Case Size

WV Cap(μF)	400V					450V				
	Size	Ripple	Typ. ESR 20°C 120Hz	MAX ESR 20°C 120Hz	Zmax (mΩ/20°C 10KHz)	Size	Ripple	Typ. ESR 20°C 120Hz	MAX ESR 20°C 120Hz	Zmax (mΩ/20°C 10KHz)
330	30x41	1600	370	520	260	30x46	1500	390	540	280
330	35x37	1680	370	520	260	35x42	1580	390	540	280
390	30x46	1800	310	440	220	35x42	1720	330	460	240
390	35x37	1800	310	440	220	35x47	1800	330	460	240
470	30x51	2020	260	370	180	35x52	2000	280	390	200
470	35x42	2020	260	370	180	35x57	2160	280	390	200
470	35x47	2100	260	370	180					
560	30x56	2320	220	310	150	35x57	2360	240	330	170
560	35x47	2320	220	310	150	35x62	2450	240	330	170
560	35x52	2440	220	310	150					
680	35x52	2700	180	250	130	35x67	2800	200	270	150
680	35x57	2700	180	250	130	40x62	2900	200	270	150
820	35x62	3080	150	210	110	40x62	3100	170	230	130
820	35x67	3200	150	210	110	40x70	3350	170	230	130
820	40x57	3200	150	210	110					
1000	40x62	3250	120	170	80					
1200	40x70	3400	100	140	70					

Ripple Current (m A, rms) at 105°C 120Hz

UL Series 105°C

Features

Extremely Long useful life

Applications

- ◆ Professional power supplies
- ◆ Frequency converters
- ◆ Uninterruptible power supplies
- ◆ Used for air conditioner, general-purpose inverter

Features

- ◆ High reliability
- ◆ Long useful life
- ◆ High ripple current capability
- ◆ Aluminum case designed explosion-proof vent
- ◆ RoHS-compatible

Construction

- ◆ Charge-discharge proof, polar
- ◆ Aluminum case with insulating sleeve
- ◆ Aluminum case designed explosion-proof vent
- ◆ Snap-in solder pins to hold component in place on PC-board



Specifications

Item	Performance Characteristics		
Operating Temperature Range	-25 to +105°C		
Rated voltage V_R	400, 450 V DC		
Surge voltage V_S	1.10 V_R		
Rated capacitance C_R	330 ~ 1000 μ F		
Capacitance tolerance	$\pm 20\%$ (120Hz, +20°C)		
Dissipation Factor $\tan \delta$ (at 20°C · 120Hz)	Less than the value under table(%)		
	W.V.(V)	400	450
D.F.(%) max	20	20	
Leakage Current I_{leak} (+20°C, max)	$\leq 3 \sqrt{CV}$ (μ A) After 5 minutes with rated working voltage applied		
Self-inductance ESL	approx. 20 nH		
Useful life 105 °C; $V_R, I_{AC}^2 R$	> 7000 h	Requirements: $\Delta C/C \leq \pm 40\%$ of initial value ESR ≤ 4 times initial specified limit $I_{leak} \leq$ initial specified limit Outlier Percentage: 0 %	
Voltage Endurance test 105 °C; V_R	5000 h	Post test requirements: $\Delta C/C \leq \pm 20\%$ of initial value ESR ≤ 2 times initial specified limit $I_{leak} \leq$ initial specified limit Outlier Percentage: 0 %	
Shelf Life 105 °C	1000 h	Post test requirements: $\Delta C/C \leq \pm 20\%$ of initial value ESR ≤ 2 times initial specified limit $I_{leak} \leq$ initial specified limit Outlier Percentage: 0 %	
Vibration Resistance test	To IEC 60068-2-6, test Fc:		
	Displacement amplitude 0.75 mm, frequency range 10 ... 55 Hz, acceleration max. 10 g, duration 3x2 h. Capacitor mounted by its body which is rigidly clamped to the work surface.		
Characteristics at low temperature	Max. impedance ratio at 120 Hz		
	V_R	≤ 400 V	≥ 450 V
$Z_{-25^\circ C} / Z_{20^\circ C}$	8	8	
Sectional specification	IEC 60384-4 and JIS-C-5101		

Multiplier for Ripple Current vs. Frequency

CAP(μF)/Frequency(Hz)	50(60)	120	400	1K	10K	50K-100K
100≤CAP≤1000	0.8	1	1.16	1.25	1.35	1.38
1000<CAP	0.8	1	1.11	1.17	1.25	1.28

Dimensional drawings

Standard 2 terminals

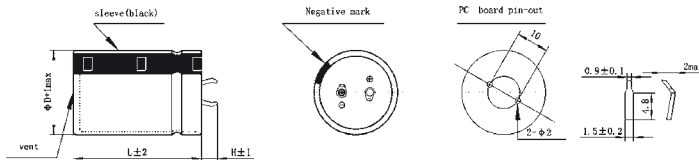

Standard snap-in terminals: length(6.0±1)mm · Also available with length of (4.0±1)mm

Vibration proof terminal T type

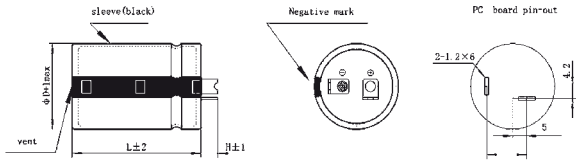

Standard snap-in terminals: length(4.5±1)mm · Also available with length of (5.5±1)mm

Useful life

depending on ambient temperature T_a versus under ripple current operating conditions

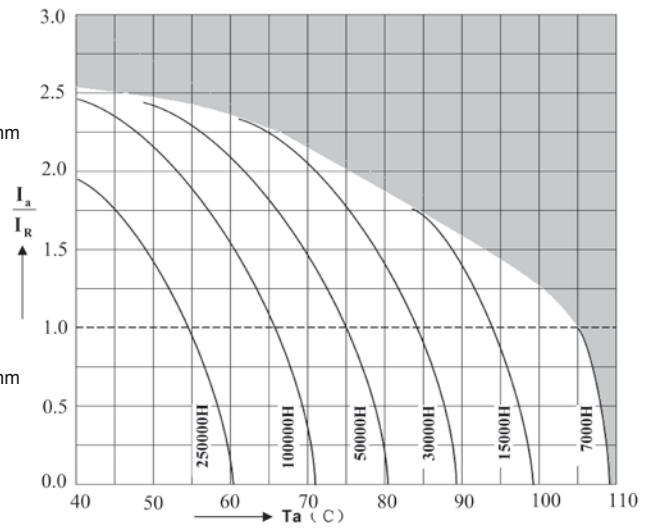

Case Size

WV	400V					450V				
	Size	Ripple	Typ. ESR 20°C 120Hz	MAX ESR 20°C 120Hz	Zmax (mΩ/20°C 10KHz)	Size	Ripple	Typ. ESR 20°C 120Hz	MAX ESR 20°C 120Hz	Zmax (mΩ/20°C 10KHz)
330	30x46	1400	310	440	220	30x51	1280	330	460	240
330	35x37	1440	310	440	220	35x42	1280	330	460	240
390	30x46	1600	260	370	180	30x56	1450	280	390	200
390	35x42	1680	260	370	180	35x47	1450	280	390	200
470	30x51	1830	220	310	150	35x52	1680	240	330	170
470	35x42	1830	220	310	150	35x57	1750	240	330	170
470	35x47	1900	220	310	150					
560	35x52	2070	190	260	130	35x57	1920	210	280	150
560	35x57	2150	190	260	130	35x62	2000	210	280	150
680	35x57	2270	160	220	110	35x67	2250	180	240	130
680	35x62	2350	160	220	110	40x62	2350	180	240	130
820	35x67	2680	130	180	90	40x67	2500	150	200	110
820	40x57	2700	130	180	90					
1000	40x70	3260	110	150	80					

Ripple Current (mA, rms) at 105°C 120Hz

RF Series Radial Type for Photo Flash

Features

- ◆ RF Series is for photo flash applications that require not only superior volumetric efficiency, low dissipation factor and low leakage current.
- ◆ These capacitors effectively convert electrostatic energy into light.
- ◆ RoHS Compliant

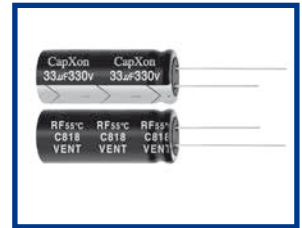

Specifications

Item	Performance Characteristics
Operating Temperature Range	-20 to +55°C
Rated Voltage Range	330/350 VDC
Capacitance Range	100 ~ 450 µ F
Capacitance Tolerance	-10% ~ +20% (120Hz, +25°C)
Leakage Current (+20°C, max.)	$I \leq 1 \times C \mu A$ max After 5 minutes with rated working voltage applied
Dissipation Factor (tan δ , at 20°C , 120Hz)	8% max.
Endurance	Test conditions Duration time :5000 Times Ambient temperature :Room Temperature (5 ~ 35°C) Applied voltage :Charge and Discharge Cycles : 30 Sec. After test requirement at +25°C Capacitance change : $\leq \pm 10\%$ of the initial measured value Dissipation factor : $\leq 150\%$ of the initial specified value Leakage current : $\leq 150\%$ of the initial specified value
Shelf Life	Test conditions Duration time :1000 Hrs Ambient temperature :+55°C Applied voltage :None After test requirement at +25°C Capacitance change : $\leq \pm 10\%$ of the initial measured value Dissipation factor : $\leq 150\%$ of the initial specified value Leakage current : $\leq 150\%$ of the initial specified value

Diagram of Dimensions:(unit:mm)

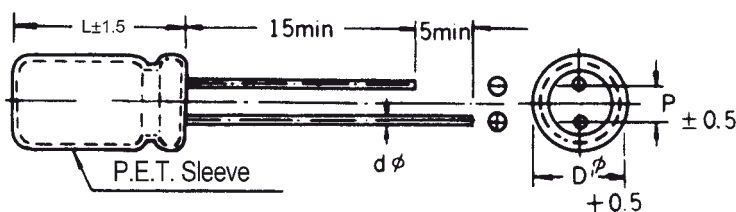

φ D	8	10	12	13	14	16	18	20
φ d	0.6	0.6	0.8	0.8	0.8	0.8	0.8	0.8
F	3.5	5			7.5			

Please check with us about individual sizes and dimensions.

SF Series Snap-in Type for Photo Flash

Features

- ◆ SF Series is for photo flash applications that require not only superior volumetric efficiency, low dissipation factor and low leakage current.
- ◆ These capacitors effectively convert electrostatic energy into light.
- ◆ RoHS Compliant



Specifications

Item	Performance Characteristics
Operating Temperature Range	-20 to +55°C
Rated Voltage Range	330/350 VDC
Capacitance Range	150 ~ 1500 µF
Capacitance Tolerance	-10% ~ +20% (120Hz, +25°C)
Leakage Current (+20°C, max.)	$I \leq 1 \times C \mu A$ max After 5 minutes
Dissipation Factor (tan δ , at 20°C , 120Hz)	8% max.
Endurance	Test conditions Duration time :5000 Times Ambient temperature :Room Temperature (5 ~ 35°C) Applied voltage :Charge and Discharge Cycles : 30 Sec. After test requirement at +25°C Capacitance change : $\leq \pm 10\%$ of the initial measured value Dissipation factor : $\leq 150\%$ of the initial specified value Leakage current : $\leq 150\%$ of the initial specified value
Shelf Life	Test conditions Duration time :1000 Hrs Ambient temperature :+55°C Applied voltage :None After test requirement at +25°C Capacitance change : $\leq \pm 10\%$ of the initial measured value Dissipation factor : $\leq 150\%$ of the initial specified value Leakage current : $\leq 150\%$ of the initial specified value

Diagram of Dimensions:(unit:mm)

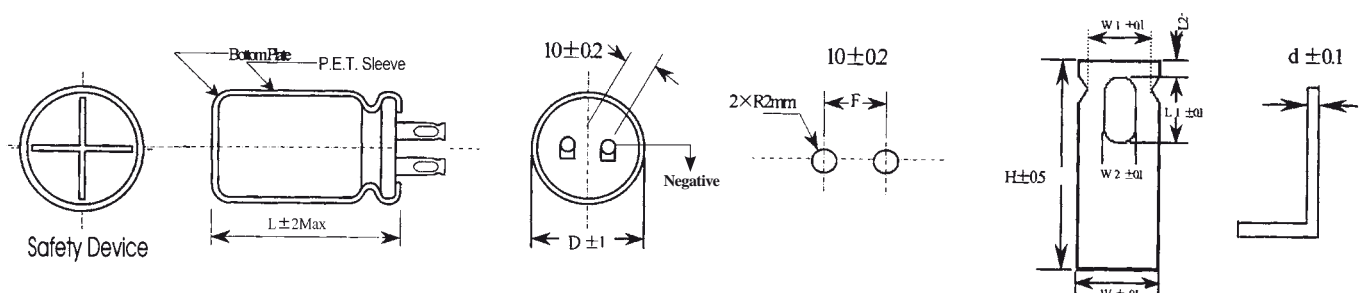

Case Size

Dφ	H±0.5	L1±0.1	L2±0.1	W±0.1	W1±0.1	W2±0.1	d±0.1
25	8.0	3.3	1.3	4.0	3.7	1.8	0.6
30	8.5	3.3	1.3	4.6	4.3	1.8	0.8
35	9.0	3.3	1.3	4.6	4.3	1.8	0.8
40	9.0	3.3	1.3	4.6	4.3	1.8	0.8

Please check with us about individual size and dimensions.

Screw

1 Definitions of electrical parameters

1.1 Voltages

1.1.1 Rated voltage

The rated voltage is the direct voltage value for which the capacitor has been designed and which is indicated upon it. For Aluminum electrolytic capacitors, rated voltages of 100 V are usually designated as "low voltage" and rated voltages >100 V as "high voltage"

1.1.2 Operating voltage

The capacitors can be operated continuously at full rated voltage (including superimposed AC voltage) within the entire operating temperature range.

1.1.3 Surge voltage

The surge voltage is the maximum voltage which may be applied to the capacitor for short periods of time, i.e. up to 5 times for 1 minute per hour. IEC 60384-4 specifies the surge voltage as follows:

for $UR \leq 315 \text{ V}$ Surge voltage = 1.15 UR

for $500 \text{ V} > \leq UR > 315 \text{ V}$ Surge voltage = 1.10 UR

1.1.4 Superimposed AC, ripple voltage

A superimposed alternating (AC) voltage, or ripple voltage, may be applied to Aluminum electrolytic capacitors provided that the sum of the DC voltage and superimposed alternating (AC) voltage does not exceed the rated voltage, and the rated ripple current is not exceeded

1.1.5 Reverse voltage

Aluminum electrolytic capacitors are polar capacitors. Where necessary voltages of opposite polarity should be prevented by connecting a diode. The diode's conducting state voltage of approximately 0.8 V is permissible. Reverse voltages 1.5 V are tolerable for a duration of less than 1 second, but not in continuous or repetitive operation.

2.2 Capacitance

2.2.1 AC and DC capacitance

The capacitance of a capacitor can be determined by measuring its AC impedance (taking into account amplitude and phase) or by measuring the charge it will hold when a DC voltage is applied. The two methods produce slightly different results. As a general rule, it can be said that DC voltage based measurements (DC capacitance) yield higher values (DC capacitance) than the alternating current method (AC capacitance). The factors are approximately 1.0 to 1.5 and maximum deviations occur with capacitors of low voltage ratings. Corresponding to the most common applications (e.g. smoothing and coupling), it is most usual to Determine the AC capacitance of Aluminum electrolytic capacitors. Corresponding to the most common applications (e.g. smoothing and coupling), it is most usual to

Determine the AC capacitance of Aluminum electrolytic capacitors.



Figure 1

Simplified equivalent circuit diagram of an electrolytic capacitor

For this purpose, the capacitive component of the equivalent series circuit (the series capacitance C_S) is determined by applying an alternating voltage of ≤ 0.5 V. As the AC capacitance depends on frequency and temperature, IEC 60384-1 and IEC 60384-4 prescribe a measuring frequency of 100 Hz or 120 Hz and a temperature of 20 °C (other reference values by special request). There are also applications (e.g. discharge circuits and timing elements) in which the DC capacity C_{DC} is decisive. In spite of this fact, capacitors for which the capacitance has been determined by the AC method are also used in such applications, whereby allowances are made to compensate for the difference between the two measuring methods.

However, in exceptional cases it may be necessary to determine the DC capacitance. The IEC Publications do not provide any corresponding specifications. Because of this, a separate DIN standard has been defined. This standard, DIN 41328-4, describes a measuring method involving one-time, non-recurrent charging and discharging of the capacitor.

2.2.2 Rated capacitance CR

The rated capacitance is the AC capacitance value for which the capacitor has been designed and which is indicated upon it. C_R is determined by specific measurement methods described in the relevant standards (IEC 60384-1 and IEC 60384-4).

2.2.3 Capacitance tolerance

The capacitance tolerance is the range within which the actual capacitance may deviate from the specific rated capacitance. Where the capacitance tolerances are to be indicated on the compo nets themselves, CapXon uses code letters to IEC 60062; this code letter is also part of the ordering code.

2.2.4 Temperature dependence of the capacitance

The capacitance of an electrolytic capacitor is not a constant quantity that retains its value under all operating conditions. The temperature has a considerable effect on the capacitance. With decreasing temperature, the viscosity of the electrolyte increases, thus reducing its conductivity. The resulting typical behavior is shown in figure 2.

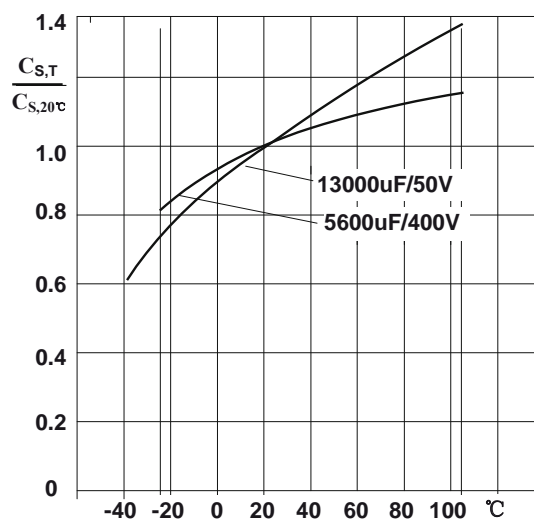

Figure 2

Temperature dependence of series capacitance C_S (typical behavior) Reference value: AC capacitance at 20°C and 120 Hz. As a general rule, the characteristic curves are steeper for lower rated voltages and increasing Anode surface roughness (deeper etching).

The most favorable flat shape of the curves shown in figure 2 is obtained by using special electrolytes which ensure that the capacitors can be operated at temperatures far below zero.

The shape of the curves varies widely, depending on whether the temperature relationship of the AC or of the DC capacitance is determined. The DC capacitance has a flatter temperature characteristic.

2.2.5 Frequency dependence of the capacitance

The AC capacitance depends not only on the temperature but also on the measuring frequency. Figure 3 shows the typical behavior. Typical values of the effective capacitance can be derived from the impedance curve, as long as the impedance is still in the range where the capacitive component is dominant.

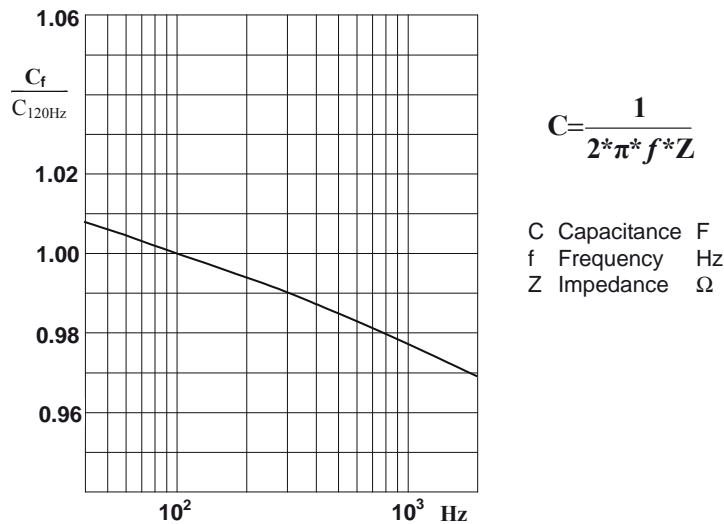

Figure 3
Capacitance C versus frequency f Typical behavior

2.2.6 Charge-discharge proof

Frequent charging/discharging cycles may lead to a decrease in capacitance. (Charge-discharge test to IEC 60384-4).

3.3 Dissipation factor $\delta \tan \delta$

The dissipation factor $\tan \delta$ is the ratio of the equivalent series resistance to the capacitive reactance component in the equivalent series circuit, or the ratio of effective power (dissipated power) to reactive power for sinusoidal voltages. It is measured using the same setup as for the series capacitance C_s (see figure 1).

3.4 Self-inductance ESL

The self-inductance or equivalent series inductance results from the terminal configuration and the internal design of the capacitor. It is defined by the equivalent series circuit shown in figure 1

3.5 Equivalent series resistance ESR

The equivalent Series Resistance is the resistive component of the equivalent series circuit. The ESR value depends on frequency and temperature and is related to the dissipation factor by the following equation:

$$ESR = \frac{\tan \delta}{\omega * C_s}$$

ESR	Equivalent series resistance
$\tan \delta$	Dissipation factor
C_s	Series capacitance

The tolerance limits of the rated capacitance must be taken into account when calculating this value.

Screw

3.6 Impedance Z

The impedance of an electrolytic capacitor results primarily from the series circuit formed by the following individual equivalent series components (figure 4):

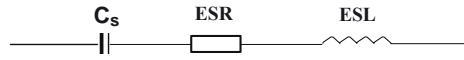

Figure 4

Simplified equivalent circuit diagram of an electrolytic capacitor

- 1) Capacitive reactance $1/\omega C_s$ of the capacitance C_s
- 2) Dielectric losses and ohmic resistance of the electrolyte and the terminals (ESR)
- 3) Inductive reactance ωESL of the capacitor winding and the terminals.

The inductive reactance ωESL only depends on the frequency, whereas $1/\omega C_s$ and ESR depend on frequency and on temperature. The characteristics of the individual resistive and reactive components determine the total impedance of the capacitor.

Capacitive reactance predominates at low frequencies. With increasing frequency, the capacitive reactance ($X_c = 1/\omega C_s$) decreases until it reaches the order of magnitude of the electrolyte resistance.

At even higher frequencies and unchanged temperatures (see 20 °C curve), the resistance of the electrolyte predominates. When the capacitor's resonance frequency is reached, capacitive and inductive reactance mutually cancels each other.

Above this frequency, the inductive resistance of the winding and its terminals ($X_L = \omega L$) becomes effective and leads to an increase in impedance.

The resistance of the electrolyte increases strongly with decreasing temperature.

3.7 Leakage current I_{Leak}

Due to the special properties of the aluminum oxide layer that serves as a dielectric, a small current will continue to flow even after a DC voltage has been applied for longer periods. This current is called the leakage current. A low leakage current is an indication that the dielectric is well designed.

3.7.1 Time and temperature dependence of the leakage current

As figure 5 shows, a high leakage current flow (inrush current) in the first minutes after applying a voltage to the capacitor, in particular after prolonged storage without any applied voltage. In the course of continuous operation, the leakage current will decrease and reach an almost constant "steady-state" value. The temperature dependence of the leakage current is shown in figure 6, taking a capacitor of the 85 °C temperature category as an example.

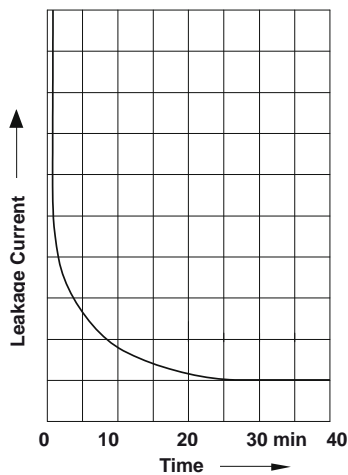

Figure 5

Leakage current versus time for which a voltage is applied

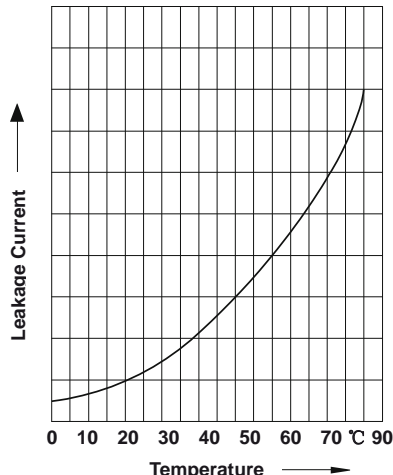

Figure 6

Leakage current versus temperature

3.7.2 Voltage dependence of the leakage current

The relationship between the leakage current and the voltage applied under constant temperature conditions is shown schematically in figure 7.

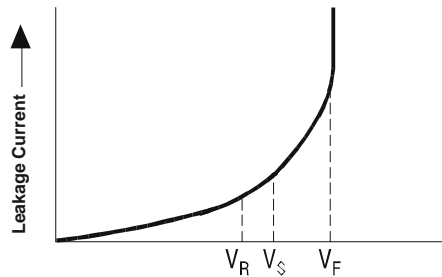

Figure 7 → V

3.7.3 Leakage current for acceptance test I_{leak}

As the leakage current varies with time and temperature, it is necessary to define reference values for measuring time and temperature. To JIS-C-5101 the leakage current is to be measured at 20°C, after the rated voltage has been applied for 5 minutes. The following equations apply:

$$I_{leak} \leq 0.3\mu A * (C * V)^{0.7} + 4\mu A$$

Acceptance testing for leakage current can be carried out at any temperature between 15°C and 35°C, Referee tests are to be carried out at 20°C.

3.7.4 Reforming

To IEC 60384-4, Aluminum electrolytic capacitors are to be subjected to a reforming process before acceptance testing. The purpose of this preconditioning is to ensure that the same initial conditions are maintained when comparing and assessing different products.

For this purpose, the rated voltage is applied to the capacitors via a series resistance of approximately 100 Ω for $V_R \leq 100$ V DC, or 1000 Ω for $V_R > 100$ V DC, for a period of one hour. Subsequently, the capacitors are stored under no-voltage conditions for 12 to 48 hours at a temperature between 15 and 35 °C. The leakage current must then be measured, at the latest after 48 hours.

If the capacitors meet the leakage current requirements without preconditioning, this procedure can be omitted.

3.7.5 Leakage current behavior with no voltage applied (voltage-free storage)

The oxide layer may deteriorate when Aluminum electrolytic capacitors are stored without an externally applied voltage, especially at higher temperatures. Since there is no leakage current to transport oxygen ions to the anode in this case, the oxide layer is not regenerated. The result is that a higher than normal leakage current will flow when a voltage is applied after prolonged storage. As the oxide layer is regenerated in use, however, the leakage current will gradually decrease to its normal level.

If aluminum electrolytic capacitors can be stored voltage-free for more than six months, Provided that these storage periods have not been exceeded, the capacitors can be operated at rated voltage directly after being taken out of storage. When designing application circuits, attention must be paid to the fact that the leakage current may be up to 100 times higher than normal during the first minutes following the application of power. When the capacitors have been stored for more than six months, it is decisive whether the circuit will tolerate high initial leakage currents. A circuit that has been stored for more than six months with the capacitors incorporated, should be operated trouble-free for one hour. This will usually regenerate the capacitors so far that storage can be continued.

3.8 Breakdown strength and insulation resistance of insulating sleeves

Most Aluminum electrolytic capacitors made by CapXon are enveloped by an insulating sleeve. The minimum breakdown strength of the sleeve is 2500 V AC or 3500 V DC. A test method for verifying the breakdown strength of the sleeves is described in IEC 60384-4.

In order to ensure full breakdown strength, care must be taken not to damage the insulating sleeve, especially when ring clips are used for mounting.

The insulation resistance of the sleeve is at least 100 M Ω . IEC 60384-4 specifies corresponding test methods.

As a standard feature, capacitors with an upper category temperature of +85 °C and +105 °C are fitted with external PET insulation.

4 Ripple current considerations

4.1 General

The term ripple current is used for the RMS value of the alternating current that flows through the device as a result of any pulsating or ripple voltage. The maximum permissible ripple current value depends on the ambient temperature, the surface area of the capacitor (i.e. heat dissipation area), the dissipation factor $\tan \delta$ (or ESR) and on the AC frequency.

As thermal stress has a decisive effect on the capacitor's life expectancy, the dissipation heat generated by the ripple current is an important factor affecting the useful life. Diagrams showing the useful life as a function of the ambient temperature T_A are given in the individual data sheets

These thermal considerations imply that, under certain circumstances, it may be necessary to select a capacitor with a higher voltage or capacitance rating than would normally be required by the respective application.

4.2 Frequency dependence of the ripple current

The dissipation factor (which is related to the equivalent series resistance) of aluminum electrolytic capacitors varies with the frequency of the applied voltage. As a result, the ripple current is also a function of the frequency. In the individual data sheets, the ripple current capability of the capacitors is generally referred to a frequency of 120 Hz, or in some cases to 10 or 20 kHz. Conversion factors for other operating frequencies are given for each type in the form of a graph.

4.3 Temperature dependence of the ripple current

The data sheets specify the maximum permissible ripple current for the upper category temperature for each capacitor type. For most of the types with category temperature above 85°C or 105°C, the ripple current ratings for 85°C or 105°C have also been included for the purpose of comparison. The data sheets for each capacitor type also include a diagram showing the limit values for continuous operation at other ambient temperatures and ripple currents. This diagram also permits the expected useful life to be estimated for given operating conditions.

5 Useful life

Useful life (also termed service life or operational life) is defined as the life achieved by the capacitor without exceeding a specified failure rate. Total failure or failure due parametric variation is considered to constitute the end of the useful life

Depending on the circuit design, device failure due to parametric variation does not necessarily

imply equipment failure. This means that the actual life of a capacitor may be longer than the specified useful life. Data on useful life have been obtained from experience gained in the field and from accelerated tests.

The useful life can be prolonged by operating the capacitor at loads below the rating values (e.g. lower operating voltage, current or ambient temperature). In addition to the standard type series, CapXon is able to offer types with useful life

ratings specially matched to customer specifications.

5.1 Load conditions

CECC defines the useful life of capacitors with liquid electrolytes on the basis of the following load conditions:

- rated voltage
- rated ripple current (the peak value of the AC voltage superimposed on the DC voltage must not exceed the rated voltage)
- rated temperature

5.3 Calculation of useful life

The tables in the individual data sheets list the rated ripple current $I_{AC,R}$ for the upper category temperature(+85°C,+105°C) and for a frequency of 120Hz. The useful life for known ripple current loads and ambient temperatures is determined on the basis of the useful life graphs as follows:

Determine the quotient $I_{AC} / I_{AC,R}$ of the required ripple current at the given ambient temperature and the rated ripple current at the upper category temperature. The corresponding useful life value is given by the curve passing through the respective ambient temperature and the current quotient coordinates, or it can be interpolated if none of the useful life curves passes directly through these coordinates.

The frequency dependence of the ripple current has not been taken into account in the procedure described above. This must be introduced into the calculation in the form of an additional factor.

For each series precise curves for conversion factor $I_{RC,f} / I_{RC,120Hz}$ versus frequency f are given in the individual data sheets.

The following examples illustrate the calculation procedure, using the data of a capacitor of the RH series. For this type series, the upper category temperature is +105 °C. As an example, a capacitor with the following ratings has been selected from the data sheets:

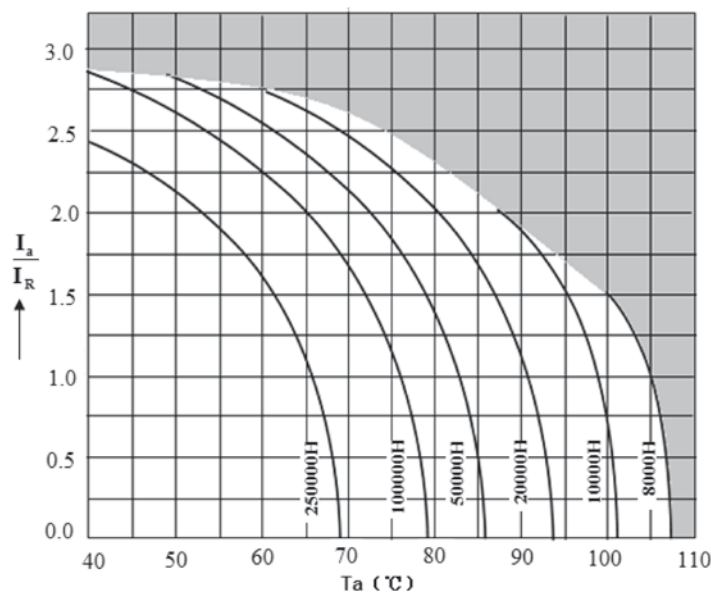

VR	CR	Case	IRC,max 120Hz 105°C A
450	6800	89*160	9.5

Example 1 – Calculating the useful life

The following values have been determined for capacitors to be used in a frequency converter. The corresponding useful life is to be calculated.

Ripple current 25 A

Frequency 400 Hz

Ambient temperature 50 °C

The equivalent ripple current for 120 Hz is calculated using the frequency-dependence conversion factor (see series RH "Frequency factor of permissible ripple current I_{RC} "):

$$\frac{25 \text{ A}}{1.25} = 20 \text{ A}$$

The ripple current factor is then calculated using the resulting equivalent 120 Hz ripple current.

$$\frac{I_{RC}}{I_{RC.R}} = \frac{20 \text{ A}}{9.5 \text{ A}} \approx 2.1$$

The useful life curve passing through the coordinates for the ripple current factor and the ambient temperature (50 °C) indicates the useful life that can be expected: 100 000 h (see figure 8).

Example 2 – Checking the ripple current load on an Aluminum electrolytic capacitor

In many applications, Aluminum electrolytic capacitors are subjected to ripple currents of varying frequencies.

The equivalent total ripple current load shall be calculated for the following given RMS values:

Current 1: $I_{RC,RMS}$ at 400 Hz 20 A

Current 2: $I_{AC,RMS}$ at 4 kHz 16 A

Ambient temperature 50°C

Required useful life 100000 h

The first step is to calculate the equivalent 120Hz values for the two current values (frequency factors given on series RH "Frequency factor of permissible ripple current I_{RC} ") and the root-mean-square value of the two equivalent values:

$$\text{Current } I_1: \frac{20 \text{ A}}{1.25} = 16 \text{ A}$$

$$\text{Current } I_2: \frac{16 \text{ A}}{1.32} \approx 12.12 \text{ A}$$

$$I_{total.RMS} = \sqrt{I_1^2 + I_2^2} = \sqrt{(16)^2 + (12.12)^2} \approx 20.07 \text{ A}$$

The ripple current factor can then be calculated

$$\frac{I_{total.RMS}}{I_{RC.R}} = \frac{23.38 \text{ A}}{9.5 \text{ A}} \approx 2.11 \text{ A}$$

The useful life curve passing through the coordinates for the ripple current factor and the ambient temperature (50 °C) indicates the useful life that can be expected: 100 000 h (see figure 8)

6 Capacitor bank design

In some applications the required capacitance may not be achieved by using a single aluminum electrolytic capacitor. This may be the case if

- the required electrical charge is too high to be stored in a single capacitor,
- the voltages that are to be applied are higher than can be attained by the permissible operating voltage ratings,
- charge-discharge and ripple current loads would generate more heat than could be safely dissipated by a single capacitor, and
- the requirements on the electrical characteristics (e.g. series resistance, dissipation factor or inductance) are so high that it would be too difficult or even impossible to implement them in a single capacitor.

In these cases, banks of capacitors connected in parallel or in series or in combined parallel and series circuits will be used. To prevent overloading of individual capacitors, the capacitance tolerance must be taken into account when determining the maximum ripple current. Furthermore, the individual capacitors must not be subjected to negative voltages when the bank is discharged.

6.1 Parallel connection of Aluminum electrolytic capacitors

If one of the capacitors in a parallel circuit fails as a result of an internal short circuit, the entire bank is discharged through the defective capacitor. In the case of large banks with high energy content this may lead to extremely abrupt and severe discharge phenomena. It is therefore advisable to take measures to prevent or limit the short-circuit discharge current. In smoothing capacitor banks, e.g., this is achieved by installing individual fuses; the principle is shown in figure 9.

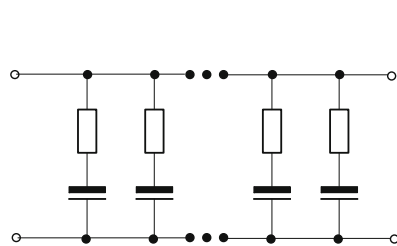

Figure 9
Individual fuses in smoothing capacitor banks

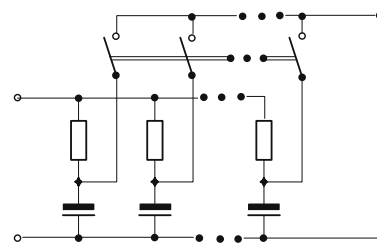

Figure 10
Protection by charging resistors

This principle is not suitable for capacitor banks designed for impulse discharges. Here, the capacitors should be protected during the charging process by means of appropriate resistors. The capacitors are then connected in parallel immediately before they are to be discharged. The principle is shown in figure 10.

6.2 Series connection of Aluminum electrolytic capacitors

When designing series circuits with Aluminum electrolytic capacitors, care must be taken to ensure that the load on each individual capacitor does not exceed its maximum permissible voltage. Here, the fact that the total DC voltage applied is divided up among the individual capacitors in proportion to their individual dielectric insulation resistances (figure 11) must be taken into consideration.

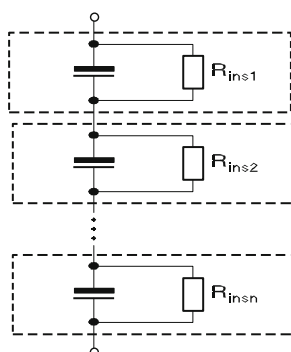

Figure 11
Series connection (with dielectric resistances)

If this is not possible, external balancing resistors $R_{\text{balance resistor}}$ (see figure 12) can be connected to the individual capacitors. The balancing resistances must be equal to one another, and must be substantially lower than the dielectric insulation resistance of the capacitor

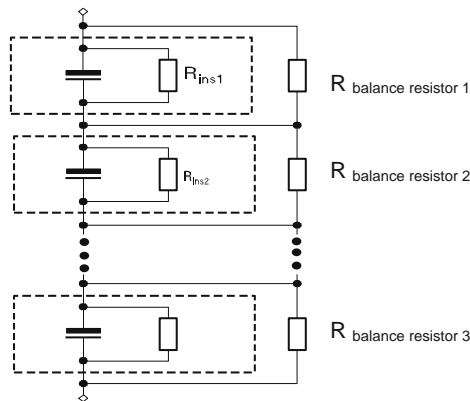

Figure 12
Series connection (external balancing resistors R connected to the individual capacitors)

Experience has shown that it is preferable to choose balancing resistance values that will cause a current of approximately 20 times the leakage current of the capacitor to flow through the resistors. The equation for calculating the resistance value is:

$$R_{\text{balance resistance}} = 50\text{M}\Omega * \mu\text{F} * \frac{1}{C_R}$$

The balancing measures described above may be omitted in cases where the total DC voltage to be applied is substantially lower than the sum of the rated voltages of the capacitors to be used.

Experience has shown that this is possible for $n = 2$ to 3 single capacitors in series without any considerable risk if the total voltage does not exceed $0.8 n V_R$. However, this solution can only be implemented if the series circuit consists of matching capacitors (same type, same capacitance), so that the dielectric insulation resistance of the capacitors, which is the only factor determining the voltage distribution in this case, will not vary too greatly from one capacitor to the next.

6.3 Combined parallel and series connection

The recommendations given above apply similarly to combinations of parallel and series circuits. If balancing resistors are to be used, it is advisable to allocate a separate resistor to each capacitor (figure 13).

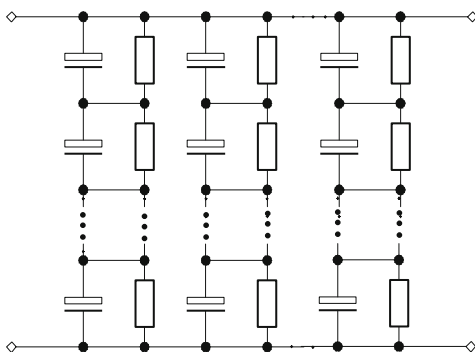

Figure 13
Combined parallel / series connection (voltage balancing by shunt resistors)

The alternative solution, parallel connection of the series capacitors in the individual branch and the use of one balancing resistor for each capacitor group, is shown in figure 14

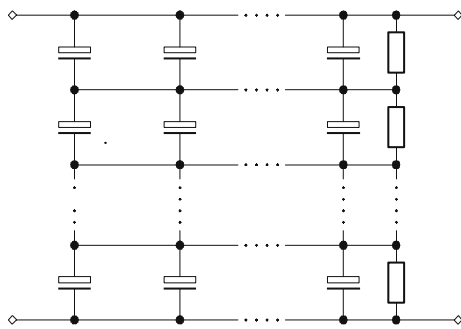

Figure 14
Combined parallel / series connection (group
voltage balancing)

7 Climatic conditions

Limits must be set for the climatic conditions to which electrolytic capacitors are subjected (in part for reasons of reliability and in part due to the variation of the electrical parameters with temperature). It is therefore important to observe the permissible minimum and maximum temperatures and the humidity conditions stated in coded form as IEC climatic category (refer to chapter "General technical information, 7.4 IEC climatic category"). The IEC categories are given for each type in the corresponding data sheet.

7.1 Minimum permissible operating temperature (lower category temperature)

The conductivity of the electrolyte diminishes with decreasing temperature, causing an increase in electrolyte resistance. This, in turn, leads to increasing impedances and dissipation factors (or equivalent series resistances). For most applications, these increases are only permissible up to a certain maximum value. Therefore, minimum permissible operating temperatures are specified for Aluminum electrolytic capacitors. These temperature limits are designated "lower category temperature" and are also part of the IEC climatic category.

It should be emphasized that operation below this temperature limit will not damage the capacitor.

Especially when a ripple current flows through the device, the heat dissipated by the increased equivalent series resistance will raise the capacitor temperature so far above the ambient temperature that the capacitance will be adequate to maintain equipment operation.

The typical response of impedance and capacitance of a capacitor with a lower category temperature of 25°C

7.2 Maximum permissible operating temperature (upper category temperature)

The upper category temperature is the maximum permissible ambient temperature at which a capacitor may be continuously operated. It depends on the capacitor design and is stated in the respective IEC climatic category. If this limit is exceeded the capacitor may fail prematurely.

For some type series, however, operation at temperatures above the upper category temperature is permissible for short periods of time. Details are given in the individual data sheets.

Useful life and reliability depend to a large extent on the capacitor's temperature. Operation at the lowest possible temperature will increase both useful life and reliability and is therefore recommended. For the same reason, it is advisable to select the coolest possible position within the equipment as a location for Aluminum electrolytic capacitors.

7.3 Storage temperature

Aluminum electrolytic capacitors can be stored voltage-free at temperatures up to the upper category temperature.

However, it must be taken into account that storage at elevated temperatures will reduce leakage current stability, useful life and reliability. In order not to impair these qualities unnecessarily, the storage temperature should not exceed +40°C and should preferably be below +25°C. The standards for Aluminum electrolytic capacitors specify a lower storage temperature that corresponds to the lower category temperature.

8 Mechanical stress resistance

8.1 Vibration resistance

The vibration resistance values are specified in the individual data sheets.

8.2 Operating altitude

Aluminum electrolytic capacitors can be used in high-altitude locations (to EN 130300 subclause 4.11.4).

8.3 Robustness of terminals

The mechanical strength of terminals and leads is defined in the respective detail specifications. Terminals of the capacitors in this book also meet the test conditions specified by IEC 60068-2-21. For tightening torques for screw terminals, refer to chapter "General technical information, 11.3 mounting torques".

9 Maintenance

CENELEC R040-001 (chapter 1 to 19) provides general information on applications in which Aluminum electrolytic capacitors are used. The most important subjects are: safety requirements and measures, installation in equipment with inherent heating, destruction by overpressure, parallel and series capacitor circuits.

Make periodic inspections for the capacitors that have been used in the devices for industrial applications. Before the inspection, make sure to turn off the power supply and carefully discharge the electricity of the capacitors. To check the capacitors, make sure of the polarity when measuring the capacitors by using a volt-ohm meter, for instance. Also, do not apply any mechanical stress to the capacitor terminals. The following items should be checked by the periodic inspections:

Significant damage to appearances: venting, electrolyte leakage, etc.

Electrical characteristics: leakage current, capacitance, tan and other characteristics prescribed in the catalogs or product specifications.

If any of the above is found, replace it or take any other proper measure.

10 Mounting

10.1 Mounting positions of capacitors with screw terminals

During operation Aluminum electrolytic capacitors will always conduct a leakage current which causes electrolysis. On one hand, the oxygen produced by electrolysis will regenerate the dielectric layer, but, on the other hand, the hydrogen released may cause increased internal pressure of the capacitor.

A safety vent in the can disk allows the gas to escape when the pressure reaches a certain level and prevents the capacitor from exploding in case of pressure increase due to an overload condition.

To prevent electrolyte from leaking out when the gas has vented, the capacitor should not be mounted with the terminals (safety vent) upside down. The recommended mounting positions to avoid a vent-down installation of the capacitor are shown in figure 15.

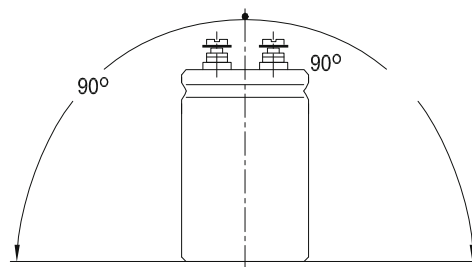

Figure 15

Recommended range of mounting positions

Upright mounting is recommended, particularly when the capacitors are fixed by their terminals, by a threaded stud or near the base.

In case of horizontal mounting, the safety vent should be at the "12 o'clock" position.

Mounting positions other than recommended will not cause any direct damage to the capacitor, but may result in serious consequential damage in the application during operation due to electrolyte leakage in the case of venting.

10.2 Soldering

Excessive time or temperature during soldering will affect capacitor's characteristics and cause damage to the insulation sleeve.

Contact of the sleeve with soldering iron must be avoided.

Soldering conditions (preheat, solder temperature and dipping time) should be within the limits prescribed in the product specifications.

10.3 Cleaning agents

Halogenated hydrocarbons may cause serious damage if allowed to come into contact with aluminum electrolytic capacitors. These solvents may dissolve or decompose the insulating film and reduce the insulating properties to below the permissible level. The capacitor seals may be affected and swell and the solvents may even penetrate them. This will lead to premature component failure.

Because of this, measures must be taken to prevent electrolytic capacitors from coming into con-

tact with the solvents when using halogenated hydrocarbon solvents to clean printed circuit boards after soldering the components, or to remove flux residues. If it is not possible to prevent the electrolytic capacitors from being wetted by the solvent, halogen-free solvents must be used

in order to eliminate the possibility of damage.

Halogen-free solvents:

Ethanol (methylated spirits) Propanol

Isopropanol Isobutanol Propylenglycoether

Diethyleneglycoldibutylether

Critical solvents:

The following list contains a selection of critical halogenated hydrocarbons and other solvents frequently used, partially in pure form, partially in mixtures with other solvents, as cleaning agents in the electrical industry.

Trichlorotrifluoroethane (trade names e.g. Freon, Kaltron, Frigene)

Trichloroethylene

Trichloroethane (trade names e.g. Chlorothene, Wacker 3 1) Tetrachloroethylene (trade name: Per)

Methylenechloride Chloroform Carbontetrachloride Acetone Methyl ethyl ketone Ethylacetate Butylacetate

However, printed-circuit board cleaning equipment is available which uses halogenated solvents but is designed to enable thorough cleaning in a very short time (four-chamber ultrasonic cleaning process). Furthermore, the processes used ensure that virtually no solvent remains on the cleaned parts.

This means that the general warning against the use of halogenated cleaning solvents on aluminum electrolytic capacitors can be qualified if the following conditions are met:

1. The cleaning period in each chamber must not exceed 1 minute.
2. The final cleaning stage must use a solvent vapor only. The temperature must be 50°C or lower.
3. Adequate drying must be ensured immediately after the cleaning process in order to evaporate any condensed residual solvent.
4. Contaminated cleaning agents must be regularly replaced as specified by the manufacturer and by legal regulations.

11 Marking of the capacitors

The example below shows how the screw capacitors are marked:

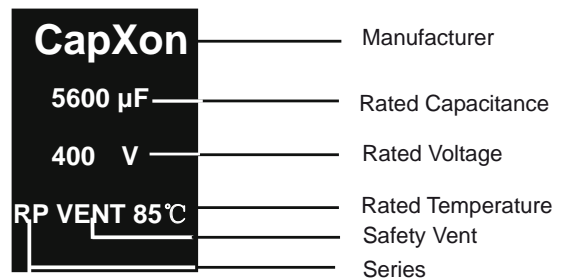

Screw

Corporate goals

We adhere to the tenet of "QUALITY FIRST", and offer satisfying products and service to the customer. This aim is shared by the CapXon quality and environment management system:

1 CapXon quality system**1.1 CapXon quality policy and environment policy**

We adhere to the tenet of "QUALITY FIRST", and offer satisfying products and service to the customer.

1.2 Quality management system

The quality management system to ISO/TS 16949:2009 is applied throughout the company and is used to implement the CapXon quality policy.

The implications include:

As a rule, product and process developments follow the rules of APQP),

Quality tools such as FMEA), MSA) and SPC) minimize risks and ensure continuous improvements in conjunction with regular internal audits and QM reviews.

1.3 Certification

The CapXon quality management system forms the basis for the company certification to ISO 9001-2008 and ISO/TS16949:2009 that comprises the CapXon plants and sales organizations.

1.4 Delivery quality

"Delivery quality" means compliance with the agreed data at the time of delivery.

1.5 Failure criteria

A component is defective if one of its features does not correspond to the specification of the data sheet or an agreed delivery specification. Failure criteria please refer to Defective degree evaluation and handling method of reliability experiment.

1.6 Incoming goods inspection at the customer

We recommend the use of a random sampling plan according to ANSI-ASQC Z 1.4 (contents compliant with MIL STD 105 D and IEC 60410) for incoming goods inspection. The test methods to be used are laid down in the relevant standards. Deviations must be agreed by the customer and the supplier.

1.7 Duration of use

The service life in terms of reliability is the time period during which random failures occur, i.e. the range in the product operating life in which the failure rate remains largely constant (early failures and end of operating life excepted). The value depends strongly on conditions of use.

1.7.1 Failure rate (long-term failure rate)

The failure rate is defined as the failure percentage divided by a specified operating period. The failure rate is expressed in fit (failures in 10^9 component hours) or as percentage of failures in 1000 hours.

$1 \text{ fit} = 1 \times 10^9 / \text{h}$ (fit = failure in time)

Example of a failure rate test determined by a useful life test:

- | | |
|--------------------------------|--------------|
| 1. Number of components tested | N = 10000 |
| 2. Operating hours | tb = 20000 h |
| 3. Number of failures | n = 2 |

$$\lambda_{\text{test}} = \frac{n}{N} * \frac{1}{t_b} = \frac{2}{10000} * \frac{1}{20000\text{H}} = 10\text{FIT} = 0.001\%/1000\text{H}$$

Failure rate specifications must include failure criteria, operating conditions and ambient conditions. Usually the failure rate of components, when plotted against time, shows a characteristic curve with the following three periods:

I: early failure period, II: useful period, III: wear-out failure period

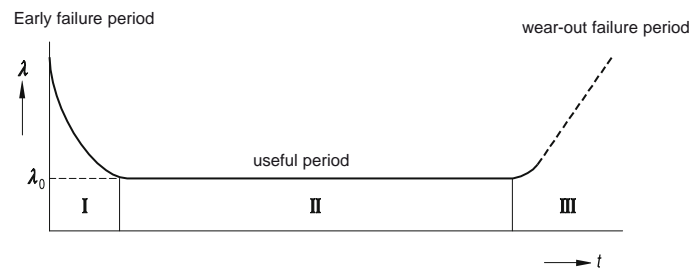

Unless otherwise specified, the failure rate refers to the useful period (II). During this period, an approximately constant failure rate λ_0 can be assumed.

1.8 AQL values

The AQL (AQL= acceptable quality level) figures are based on a random sampling plan to ANSI-ASQC Z1.4.

The sampling instructions of this standard are such that a delivered lot will be accepted with a probability of 90% if the percentage of non-conformancies does not exceed the stated AQL figure. As a rule, the percentage of non-conformancies in deliveries from CapXon is significantly below the AQL figure. The acceptance value we apply to inoperatives, i.e. unusable components is $c = 0$.

2 Environmental management system

2.1 Environmental policy

CapXon defines the following environmental protection principles:

Comply with the law, Govern the pollution, Produce Cleanly, Reduce the consume, Save resource, Cut down the toxic substance, Make Improvement Continuously, Beautify the environment

2.2 Environmental management system

The CapXon ISO 14001 based environmental management system is applied company wide for implementing the CapXon environmental policy. It is posted on the CapXon Intranet and is thus accessible to all employees.

2.3 Environmental Hazardous Substances Free management system

The CapXon QC080000 based HSF management system is applied company wide for implementing the CapXon environmental Hazardous Substances management. that Capxon products effectively in the management of hazardous substances.

2.4 Certification

2.4.1 The CapXon Group operates an environmental management system that conforms to the requirements of ISO14001 and is mandatory for all plants. The CapXon Group operates an environmental Hazardous Substances Free management system that conforms to the requirements of QC080000 and is mandatory for all plants. The company certificate is posted on the CapXon internet:

(www.capxongroup.com).

2.4.2 SONY GP certification: On Nov 2011, CAPXON have already got the SONY GP certification .GP NO.:FC012746

2.4.3 C-ROHS certification: On Dec 2012, CAPXON have already got the C-ROHS certification. products type: SMD

type, Snap-in type and Radial type.

2.5 RoHS

The term “RoHS-compatible” shall mean the following:

The components described as “RoHS-compatible” are compatible with the requirements of the regulations listed below (“Regulations”) and with the requirements of the provisions which will result from transformation of the Regulations into national law to the extent such provisions reflect the Regulations:

Directive 2002/95/EC of the European Parliament and of the Council of January 27, 2003 on the restriction of the use of certain hazardous substances in electrical and electronic equipment

("Directive 2002/95/EC"); The directive from July 1, 2006 entered into force.

Commission Decision of August 18, 2005 amending Directive 2002/95/EC (2005/618/EC); Commission Decision of October 13, 2005 and of October 21, 2005 amending the Annex to Directive 2002/95/EC (2005/717/EC, 2005/747/EC, 2006/310/EC, 2006/690/EC).

December 3, 2008 The European Commission published its official Web site of the RoHS directive revised draft COM (2008) 809 / 4.

September 3, 2009 RoHS EU issued a revised second draft Directive COM (2008) 809 final.

October 22, 2009 EU Environment Public Health and Food Safety Committee (Committee on the environment, public health and food safety) released on COM (2008) 809 of the amendments.

July 1, 2011, the European Parliament and Council issued directive 2011/65/EU (ROHS.2.0) in the official Journal of the European Union to replace the 2002/95/EC. The new directive has been fully implemented on January 1, 2013, the old directive 2002/95/EC has been abolished.

RoHS Directive, also known as Amendment RoHS 2.0, the amendment involves a lot of content. But the basic objectives and mechanisms have not been changes, the ultimate goal still is to reduce the electrical and electronic products of certain hazardous substances.

The instruction modified to increase 4 to be "priority review" the use of substances HBCDD, DEHP, DBP and BBP.

2.6 Halogen Free (HF)

Based on customer and environmental regulations on the management and control requirements of halogen, such as the European 2002-95-EC, IEC 61249-2-1, "Montreal Protocol on Substances that Deplete the Ozone Layer", "Controls the Stockholm joint pledge about durable organic pollutant", CapXon has imported halogen-free materials of all electrolytic capacitors completely at the beginning of June, 2009. All products shipped meet the halogen-free requirements on 31st, Oct, 2009.

2.7 Banned and Environmental Hazardous Substances in components

As a manufacturer of passive components, we develop our products on the basis of sustainability.

In order to guarantee a standardized procedure for CapXon Group, a mandatory list of Environmental Hazardous Substances of special interest is part of our environmental management system. The planning and development instructions include regulations and guidelines that aim to identify environmental aspects and to optimize products and processes with respect to material use and environmental compliance, to design them with sparing use of resources and to substitute hazardous substances as far as possible.

In consideration of the environmental aspects are checked and recorded in the design reviews: the environmental officer provides support in the assessment of the environmental impacts of a development project.

2.8 Product Series and Specifications for product catalog

CapXon Product Series and Specifications on the Internet (www.capxongroup.com), It is available to refer to check for customers.

2.9 Disposal

All aluminum electrolytic capacitors can be disposed off, reused or recycled. However as disposal is regulated by national law, the respective national provisions have to be observed.

RS Series 85°C

Features

General capacitors

Applications

- ◆ Frequency converters
- ◆ Professional power supplies
- ◆ Uninterruptible power supplies

Features

- ◆ Wide temperature range
- ◆ All-welded construction ensures reliable electrical contact
- ◆ Self-extinguishing electrolyte
- ◆ RoHS-compatible

Construction

- ◆ Charge-discharge proof, polar
- ◆ Aluminum case with insulating sleeve
- ◆ Poles with screw terminal connections
- ◆ Mounting with ring clips, clamps or threaded stud



Specifications

Item	Performance Characteristics					
Rated voltage V_R	16... 100 V DC					
Surge voltage V_S	1.15 V_R					
Rated capacitance C_R	3300 ... 1000000 μF					
Capacitance tolerance	$\pm 20\%$					
tan δ (at 20°C · 120Hz)	Less than the value under table(%)					
	ΦD	35	51	63.5	76.2	89
	WV	60	70	80	120	140
	16	40	50	70	80	130
	25	30	50	60	70	90
	35	25	30	50	60	80
	50	20	25	30	40	60
	63	20	20	25	30	50
80	15	20	25	30	30	
Leakage Current I_{leak} (20 °C, 5 min)	$I_{\text{leak}} \leq 0.3\mu\text{A} * (C * V)^{0.7} + 4\mu\text{A}$					
Endurance test 85 °C; V_R	2000 h	Requirements: $\Delta C/C \leq \pm 20\%$ of initial value ESR ≤ 2 times initial specified limit leak \leq initial specified limit				
Vibration Resistance test	To IEC 60068-2-6, test Fc: Displacement amplitude 0.75 mm, frequency range 10 ... 55 Hz, acceleration max. 10 g, duration 3X2 h. Capacitor mounted by its body which is rigidly clamped to the work surface.					
Low Temperature Characteristics	$Z_{-25^\circ\text{C}} / Z_{20^\circ\text{C}}$		3			
	$Z_{-40^\circ\text{C}} / Z_{20^\circ\text{C}}$		12			
Sectional specification	IEC 60384-4 and JIS-C-5101					

Dimensional drawings

Ring clip/clamp mounting:

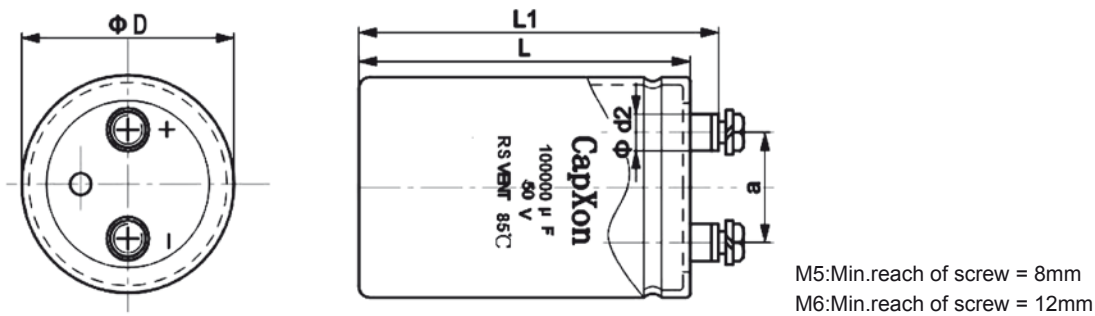

M5:Min.reach of screw = 8mm
M6:Min.reach of screw = 12mm

Dimensions

Terminal	Dimensions(mm) with insulating sleeve				
	D±2	L±3	L ₁ ±3	d ₂ max.	a±0.5
M5	35	50~120	56.5~126.5	10.3	12.7
M5	51	80~140	86.5~146.5	10.3	22
M5	63.5	80~140	86.5~146.5	10.3	28.6
M5	76.2/89	100~240	106.4~246.5	10.3	31.8
M6	76.2/89	100~240	106.4~246.5	17.5	31.8

Packing

Diameter D(mm)	Length L(mm)	Packing (pcs.)
35	≤70mm	120
	>70mm	60
42	≤70mm	120
	>70mm	60
51	≤70mm	70
	>70mm	35
63.5	all	24
76.2	all	15
89	all	12

Accessories

The following items are included in the delivery package, but are not fastened to the capacitors.

	Thread	Maximum torque
For terminal	M5	2 Nm
	M6	2.5 Nm

Case Size

φ D x L (mm)

WV(V) Cap (μ F)	16		25		35		50	
	Size	Ripple	Size	Ripple	Size	Ripple	Size	Ripple
6800							35x50	3.7
10000					35x60	4.5	35x60	5.0
15000			35x50	5.0	35x80	5.7	35x80	7.8
22000	35x60	7.3	35x60	7.7	35x80 35x100	8.0 9.0	35x100 35x120	11.5 12.8
33000	35x60 35x80	8.5 9.5	35x80	10	35x100	11.0	51x80 51x100	11.8 13.2
47000	35x80 35x100	11.0 12.0	35x100 35x105	12.5 13.0	35x120	13.7	51x100	14.7
68000	35x100 35x105 51x80	11.3 13.0 13.5	35x120 51x80	13.5 14.3	51x80 51x100	14.5 15.1	51x120 51x140	16.5 17.8
100000	35x120 51x80 51x100	13.5 14.0 15.0	51x100 51x105	15.5 16.0	51x120	19.2	63.5x120 63.5x140 76.2x100	19.0 21.5 19.5
150000	51x80 51x100 51x140	15.0 16.5 17.6	51x120 51x140 63.5x105	21.2 24.2 24.0	63.5x120	25.0	76.2x120 76.2x140	26.5 28.0
220000	51x120 63.5x105 63.5x120	17.8 20.0 21.5	63.5x120	25.8	76.2x100 76.2x140	26.0 27.4	76.2x160 89x130	32.7 32.5
330000	63.5x105 63.5x120 63.5x140	21.0 23.0 25.2	76.2x120 76.2x140	26.7 28.5	76.2x140 76.2x160	33.0 35.7	89x160	36.0
470000	76.2x120 76.2x140	25.5 27.5	76.2x150	31.3	89x170	39.0	89x220	41.0
680000	76.2x160	35.1	89x160	37.0	89x220	41.0		
820000	76.2x220	38.0	89x190	40.0				
1000000	89x200	41.1	89x220	42.0				

Ripple Current(A,rms) at 85°C 120Hz

WV(V) Cap (μ F)	63		80		100	
	Size	Ripple	Size	Ripple	Size	Ripple
3300					35x60 35x80	4.1 5.8
4700			35x60	5.0	35x80	6.7
6800	35x50	5.0	35x60	6.0	35x80 35x105	8.0 8.7
10000	35x60 35x80	6.2 7.7	35x80	8.0	35x100 51x80	9.0 10.0
15000	35x80 35x105	8.7 10.0	35x120	11.0	51x80 51x100 51x105	11.0 12.4 13.0
22000	35x120 51x80	13.1 13.0	51x80	14.0	51x120 63.5x105	16.2 17.0
33000	51x100 51x105	13.9 14.0	51x120	16.1	51x140 76.2x105	21.3 23.0
47000	51x120 63.5x105	18.6 19.0	63.5x120	21.0	63.5x140 76.2x140	24.3 25.0
68000	63.5x120 76.2x105	21.3 22.0	63.5x140	24.1	76.2x140	26.4
100000	76.2x120 76.2x145	24.0 25.0	76.2x160	27.0	89x160	27.2
150000	76.2x160	27.0	89x160	30.0	89x230	29.0
220000	89x160	29.0	89x230	35.0		
330000	89x220	32.0				

Ripple Current(A,rms) at 85°C 120Hz

RG Series 85°C

Features

Standard capacitors

Applications

- ◆ Frequency converters
- ◆ Uninterruptible power supplies

Features

- ◆ All-welded construction ensures reliable electrical contact
- ◆ Self-extinguishing electrolyte
- ◆ RoHS-compatible

Construction

- ◆ Charge-discharge proof, polar
- ◆ Aluminum case with insulating sleeve
- ◆ Poles with screw terminal connections
- ◆ Mounting with ring clips, clamps



Specifications

Item	Performance Characteristics					
Rated voltage V_R	160... 450 V DC					
Surge voltage V_S	1.15 V_R (for $V_R \leq 315$ V) or 1.10 V_R (for $V_R > 315$ V)					
Rated capacitance C_R	680 ... 68000 μ F					
Capacitance tolerance	$\pm 20\%$					
tan δ (at 20°C, 120Hz)	Less than the value under table(%)					
	ΦD	35	51	63.5	76.2	89
	WV	15	15	20	20	20
		20	20	25	25	25
Leakage Current I_{leak} (20 °C, 5 min)	$I_{leak} \leq 0.3\mu A * (C * V)^{0.7} + 4\mu A$					
Self-inductance ESL	d = 51 mm: approx. 17 nH					
	d \geq 63.5 mm: approx. 20 nH					
	Capacitors with low-inductance design:					
	d \geq 63.5 mm: approx. 15 nH					
Useful life 85 °C; V_R, I_{AC^*R}	> 6000 h	Requirements: $\Delta C/C \leq \pm 40\%$ of initial value ESR \leq 4 times initial specified limit $I_{leak} \leq$ initial specified limit				
Voltage Endurance test 85 °C; V_R	2000 h	Post test requirements: $\Delta C/C \leq \pm 20\%$ of initial value ESR \leq 2 times initial specified limit $I_{leak} \leq$ initial specified limit				
Vibration Resistance test	To IEC 60068-2-6, test Fc:					
	Displacement amplitude 0.75 mm, frequency range 10 ... 55 Hz, acceleration max. 10 g, duration 3X2 h. Capacitor mounted by its body which is rigidly clamped to the work surface.					
Low Temperature Characteristics	Max. impedance ratio at 120 Hz					
	V_R	≤ 400 V	≥ 450 V			
	$Z_{-25^\circ C} / Z_{20^\circ C}$	6	4			
	$Z_{-40^\circ C} / Z_{20^\circ C}$	22	16			
Sectional specification	IEC 60384-4 and JIS-C-5101					

Dimensional drawings

Ring clip/clamp mounting:

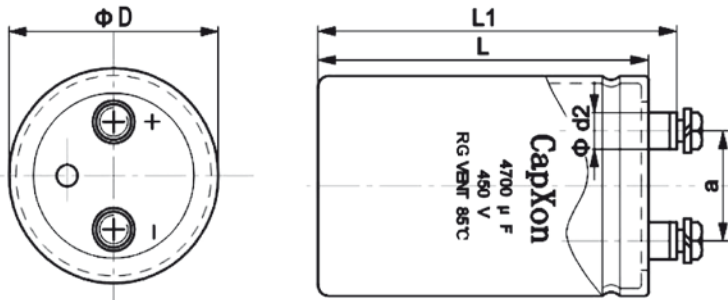

M5:Min.reach of screw = 8mm
M6:Min.reach of screw = 12mm

Dimensions

Terminal	Dimensions(mm) with insulating sleeve				
	D±2	L±3	L ₁ ±3	d ₂ max.	a±0.5
M5	35	50~120	56.5~126.5	10.3	12.7
M5	51	80~140	86.5~146.5	10.3	22
M5	63.5	80~140	86.5~146.5	10.3	28.6
M5	76.2/89	100~240	106.4~246.5	10.3	31.8
M6	76.2/89	100~240	106.4~246.5	17.5	31.8

Packing

Diameter D(mm)	Length L(mm)	Packing (pcs.)
35	≤70mm	120
	>70mm	60
42	≤70mm	120
	>70mm	60
51	≤70mm	70
	>70mm	35
63.5	all	24
76.2	all	15
89	all	12

Accessories

The following items are included in the delivery package, but are not fastened to the capacitors.

	Thread	Maximum torque
For terminal	M5	2 Nm
	M6	2.5 Nm

Case Size

φ D×L(mm)

WV(V) Cap(μF)	160		200		250	
	Size	Ripple	Size	Ripple	Size	Ripple
680					35x60	1.80
1000	35x60	2.80	35x60	3.00	35x80	3.30
1500	35x60	3.00	35x80	3.30	35x80	3.50
2200	35x80	3.50	35x100	4.20	35x120	3.80
	35x100	4.00			51x80	4.00
2700			35x120	4.70	51x80	4.40
3300	35x100	4.70	35x120	4.80	51x100	5.40
	35x120	5.20	51x80	4.90	51x120	5.80
3900	51x80	5.30	51x80	5.50	51x115	6.30
4700	51x80	6.00	51x100	6.40	51x120	7.00
					51x140	7.50
					63.5x100	7.30
6800	51x100	7.80	51x120	7.30	51x140	8.50
	51x120	8.50	51x140	9.00	63.5x120	9.20
8200					76.2x100	9.50
	51x120	9.20	63.5x100	9.40	63.5x115	10.00
10000	51x140	10.50	63.5x100	10.40	76.2x120	11.50
	63.5x100	10.50	63.5x120	11.20	76.2x140	12.30
12000	63.5x100	11.50	76.2x100	12.10	76.2x115	12.90
15000	63.5x120	12.50	76.2x120	13.00	76.2x150	14.50
	63.5x140	14.50	76.2x140	14.20	76.2x160	15.10
	76.2x100	13.00			89x120	14.50
22000	76.2x120	16.50	76.2x160	17.80	89x160	18.50
	76.2x140	17.00	89x120	17.00		
27000	76.2x140	18.00	89x130	18.00		
68000	89x230	23.00				

Ripple Current(A,rms) at 85°C 120Hz

φ DxL(mm)

WV(V) Cap(μF)	350		400		450	
	Size	Ripple	Size	Ripple	Size	Ripple
1000	35x100	4.50	35x120	4.60	51x80	4.50
			51x80	4.60	51x105	5.00
1500	51x80	4.90	51x80	5.40	51x100	5.80
			51x100	5.70	51x120	6.30
			51x105	6.00	63.5x80	6.00
2200	51x100	6.60	51x100	6.90	51x120	7.30
	51x105	6.80	51x120	7.40	63.5x100	7.60
	51x120	7.20	51x140	7.70	63.5x105	7.80
					63.5x120	8.30
2700	63.5x80	7.50	63.5x105	8.50	76.2x105	9.00
3300	51x120	8.00	51x130	8.60	63.5x120	9.50
	51x140	8.30	63.5x100	8.90	63.5x140	10.00
	63.5x100	8.10	63.5x120	9.40	76.2x120	10.50
3900	63.5x105	9.80	76.2x100	10.30	76.2x120	11.00
			76.2x105	10.50	76.2x140	12.00
4700	63.5x120	10.50	76.2x100	11.00	76.2x120	12.00
	63.5x140	11.20	76.2x120	12.00	76.2x140	13.00
	76.2x100	10.50			76.2x160	13.50
5600	63.5x140	12.50	76.2x140	13.80	76.2x160	14.00
6800	76.2x120	14.00	76.2x140	15.00	76.2x160	15.00
	76.2x140	14.90	76.2x160	16.00		
	89x100	14.00				
8200	76.2x160	16.00	76.2x160	16.50	76.2x220	18.00
10000	76.2x160	16.50	76.2x160	16.70	76.2x220	19.00
	89x120	16.00	89x130	16.70	89x170	19.00
12000	76.2x180	20.50	89x160	19.50		
	76.2x220	22.50	89x220	23.00		
15000	89x160	23.00	76.2x230	26.50		
	89x220	26.50	89x180	26.00		
			89x220	28.00		
18000	89x220	30.00	89x240	31.00		
22000	89x230	33.00				

Ripple Current(A,rms) at 85°C 120Hz

Useful life

depending on ambient temperature T_a versus under ripple current operating conditions

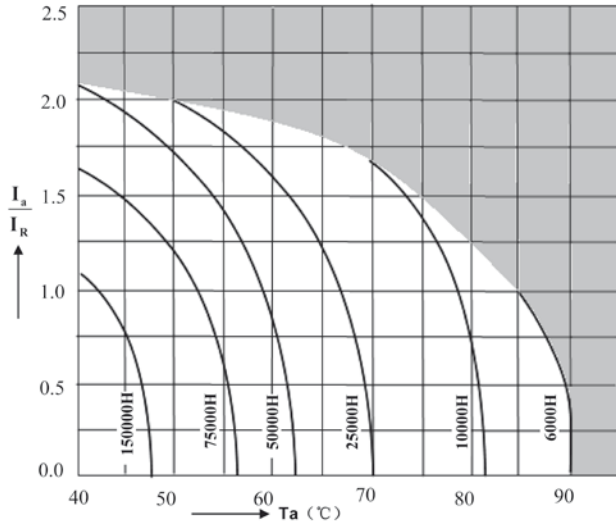

Frequency factor of permissible ripple current I_{RC} versus frequency f

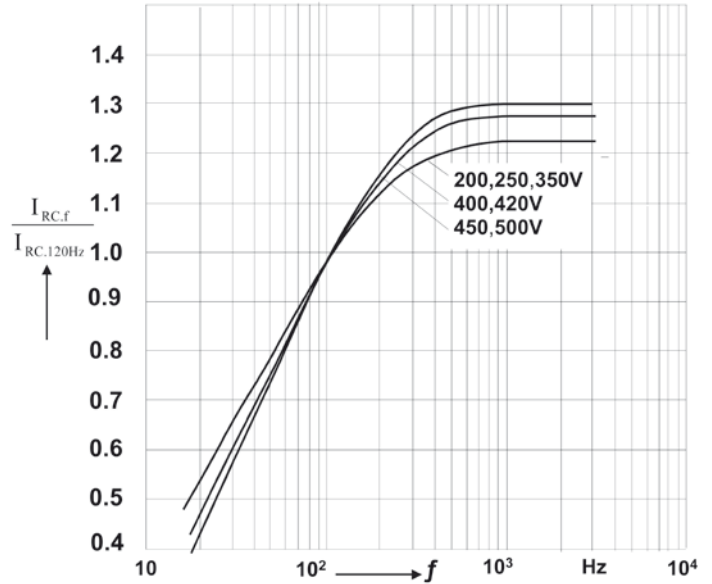

Frequency characteristics of ESR Typical behavior

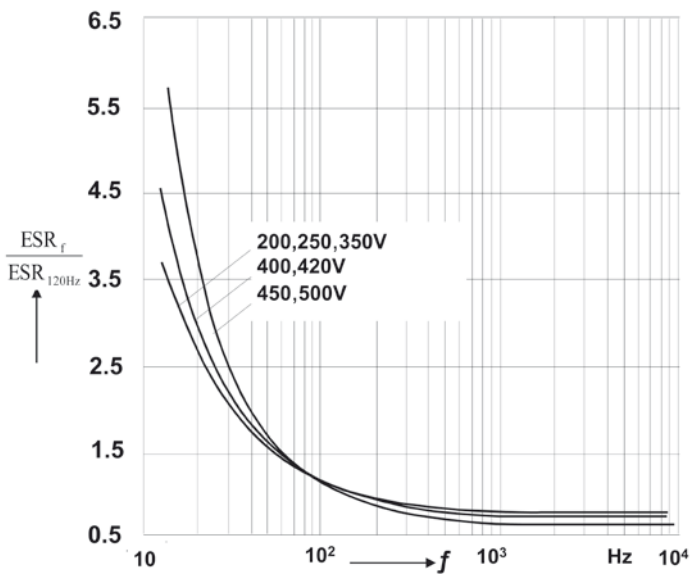

Impedance Z versus frequency f

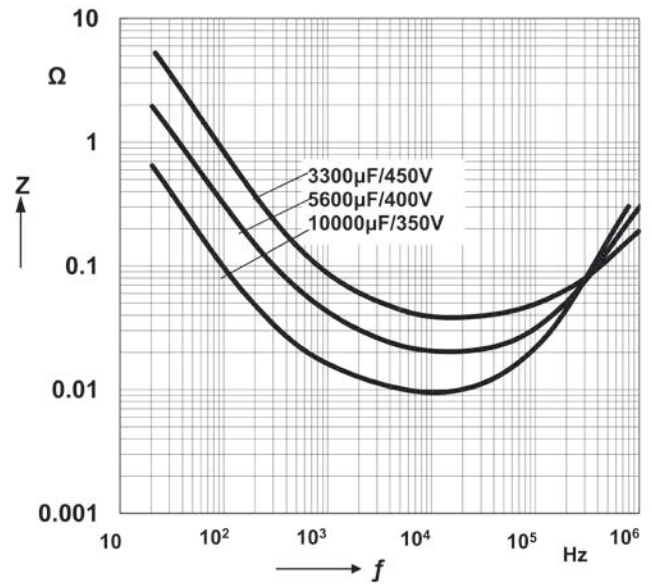

RP Series 85°C

Features

Long useful life

Applications

- ◆ Professional power supplies
- ◆ Frequency converters
- ◆ Uninterruptible power supplies

Features

- ◆ WLong useful life
- ◆ High reliability
- ◆ All-welded construction ensures reliable electrical contact
- ◆ Version with low-inductance design available
- ◆ Self-extinguishing electrolyte
- ◆ RoHS-compatible

Construction

- ◆ Charge-discharge proof, polar
- ◆ Aluminum case with insulating sleeve
- ◆ Poles with screw terminal connections
- ◆ Mounting with ring clips, clamps or threaded stud



Specifications

Item	Performance Characteristics					
Rated voltage V_R	160... 450 V DC					
Surge voltage V_S	1.15 V_R (for $V_R \leq 315$ V) or 1.10 V_R (for $V_R > 315$ V)					
Rated capacitance C_R	680 ... 68000 μ F					
Capacitance tolerance	$\pm 20\%$					
tan δ (at 20°C , 120Hz)	Less than the value under table(%)					
	ΦD	35	51	63.5	76.2	89
	WV	15	15	20	20	20
		20	20	25	25	25
Leakage Current I_{leak} (20 °C, 5 min)	$I_{leak} \leq 0.3\mu A * (C*V)^{0.7} + 4\mu A$					
Self-inductance ESL	d = 51 mm: approx. 17 nH					
	d \geq 63.5 mm: approx. 20 nH					
	Capacitors with low-inductance design: d \geq 63.5 mm: approx. 15 nH					
Useful life 85 °C; V_R, I_{AC}^R	> 10000 h	Requirements: $\Delta C/C \leq \pm 50\%$ of initial value ESR \leq 5 times initial specified limit $I_{leak} \leq$ initial specified limit				
Voltage Endurance test 85 °C; V_R	2000 h	Post test requirements: $\Delta C/C \leq \pm 20\%$ of initial value ESR \leq 2 times initial specified limit $I_{leak} \leq$ initial specified limit				
Vibration Resistance test	To IEC 60068-2-6, test Fc:					
	Displacement amplitude 0.75 mm, frequency range 10 ... 55 Hz, acceleration max. 10 g, duration 3X2 h. Capacitor mounted by its body which is rigidly clamped to the work surface.					
Low Temperature Characteristics	Max. impedance ratio at 120 Hz					
	V_R	≤ 400 V	≥ 450 V			
	$Z_{-25^\circ C} / Z_{20^\circ C}$	4	3			
	$Z_{-40^\circ C} / Z_{20^\circ C}$	16	12			
Sectional specification	IEC 60384-4 and JIS-C-5101					

Dimensional drawings

Ring clip/clamp mounting:

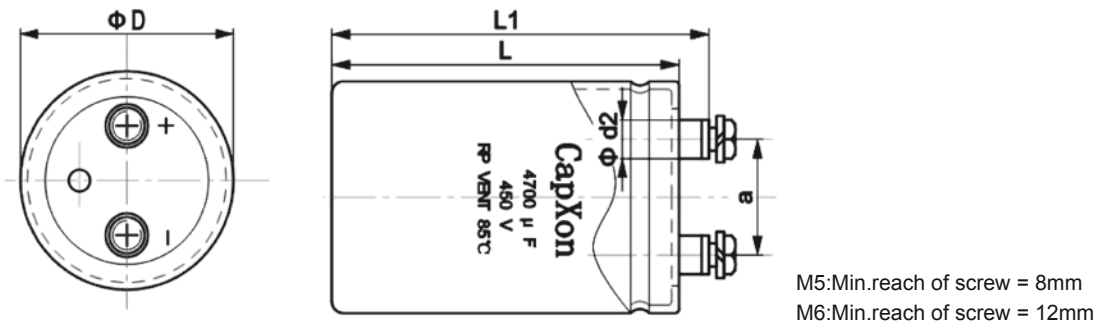

M5:Min.reach of screw = 8mm
M6:Min.reach of screw = 12mm

Dimensions

Terminal	Dimensions(mm) with insulating sleeve				
	$D \pm 2$	$L \pm 3$	$L_1 \pm 3$	$d_2 \text{max.}$	$a \pm 0.5$
M5	35	50~120	56.5~126.5	10.3	12.7
M5	51	80~140	86.5~146.5	10.3	22
M5	63.5	80~140	86.5~146.5	10.3	28.6
M5	76.2/89	100~240	106.4~246.5	10.3	31.8
M6	76.2/89	100~240	106.4~246.5	17.5	31.8

Packing

Diameter D(mm)	Length L(mm)	Packing (pcs.)
35	$\leq 70\text{mm}$	120
	$> 70\text{mm}$	60
42	$\leq 70\text{mm}$	120
	$> 70\text{mm}$	60
51	$\leq 70\text{mm}$	70
	$> 70\text{mm}$	35
63.5	all	24
76.2	all	15
89	all	12
100	all	6

Accessories

The following items are included in the delivery package, but are not fastened to the capacitors.

	Thread	Maximum torque
For terminal	M5	2 Nm
	M6	2.5 Nm

Case Size

φ DxL(mm)

WV(V) Cap(μF)	160		200		250	
	Size	Ripple	Size	Ripple	Size	Ripple
680					35x60	2.5
1000	35x60	2.8	35x60	3.0	35x80	3.1
1500	35x60	3.1	35x80	3.5	35x80	3.8
2200	35x80	4.2	35x100	4.8	35x120	5.3
	35x100	4.7			51x80	5.4
2700			35x120	5.5	51x80	5.8
3300	35x100	6.0	35x120	6.2	51x100	6.8
	35x120	6.8	51x80	6.3	51x120	7.5
3900	51x80	7.2	51x80	6.8	51x115	8.0
4700	51x80	7.5	51x100	7.8	51x120	8.5
					51x140	9.1
					63.5x100	8.8
6800	51x100	10.0	51x120	9.0	51x140	9.5
	51x120	11.5	51x140	9.8	63.5x120	9.8
					76.2x100	10.0
8200	51x120	12.0	63.5x100	11.0	63.5x115	11.5
10000	51x140	13.4	63.5x100	12.0	76.2x120	12.5
	63.5x100	13.0	63.5x120	13.0	76.2x140	13.3
12000			76.2x100	14.4	76.2x115	14.0
15000	63.5x120	13.5	76.2x120	16.0	76.2x150	16.0
	63.5x140	14.8	76.2x140	17.0	76.2x160	16.5
	76.2x100	14.0			89x120	16.0
22000	76.2x120	17.6	76.2x160	19.6	89x160	21.0
	76.2x140	18.9	89x120	18.8		
27000			89x130	21.5		
33000	76.2x160	22.0	89x160	25.0	89x220	23.0
	89x140	23.0				
47000	89x170	25.0	89x220	27.0	100x240	25.0
68000	89x230	27.0				

Ripple Current(A,rms) at 85°C 120Hz

Case Size

φ DxL(mm)

WV(V) Cap(μF)	350		400		450	
	Size	Ripple	Size	Ripple	Size	Ripple
1000			35x120	5.0	51x80	4.6
			51x80	5.0	51x105	5.0
1500	51x80	5.3	51x80	6.2	51x100	6.2
			51x100	6.8	51x120	6.7
			51x105	6.9	63.5x80	6.4
2200	51x100	6.9	51x100	7.3	51x120	7.5
	51x105	7.1	51x120	8.0	63.5x100	7.8
	51x120	7.4	51x140	8.5	63.5x105	8.0
					63.5x120	8.5
2700	63.5x80	8.0	63.5x105	9.3	76.2x105	9.2
3300	51x120	8.5	51x130	9.8	63.5x120	10.3
	51x140	9.0	63.5x100	10.0	63.5x140	11.0
	63.5x100	8.7	63.5x120	10.8	76.2x120	11.3
3900	63.5x105	10.2	76.2x100	11.5	76.2x120	12.0
			76.2x105	11.8	76.2x140	12.8
4700	63.5x120	11.5	76.2x100	12.0	76.2x120	13.0
	63.5x140	12.0	76.2x120	13.0	76.2x140	14.0
	76.2x100	11.5			76.2x160	14.8
5600	63.5x140	13.0	76.2x140	14.5	76.2x160	15.0
6800	76.2x120	15.0	76.2x140	16.0	76.2x160	16.0
	76.2x140	16.0	76.2x160	17.0		
	89x100	15.0				
8200	76.2x160	17.5	76.2x160	18.0	76.2x220	19.0
10000	76.2x160	18.0	76.2x160	19.5	76.2x220	21.0
	89x120	16.5	89x130	19.5	89x170	20.0
12000	76.2x180	22.0	89x160	22.0		
	76.2x220	25.0	89x220	25.0		
15000	89x160	26.5	76.2x230	27.0		
	89x220	30.0	89x180	26.0		
			89x220	28.5		
18000	89x220	33.0	89x240	33.0		
22000	89x230	35.0	100x240	36.0		

Ripple Current(A,rms) at 85°C 120Hz

Useful life

depending on ambient temperature T_a versus under ripple current operating conditions

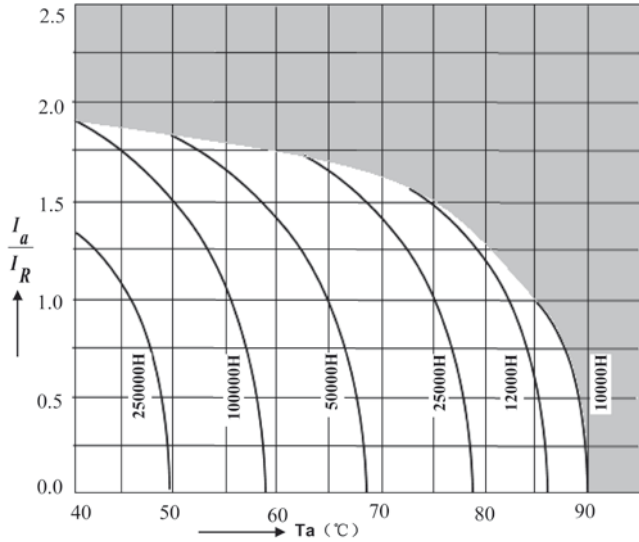

Frequency factor of permissible ripple current I_{RC} versus frequency f

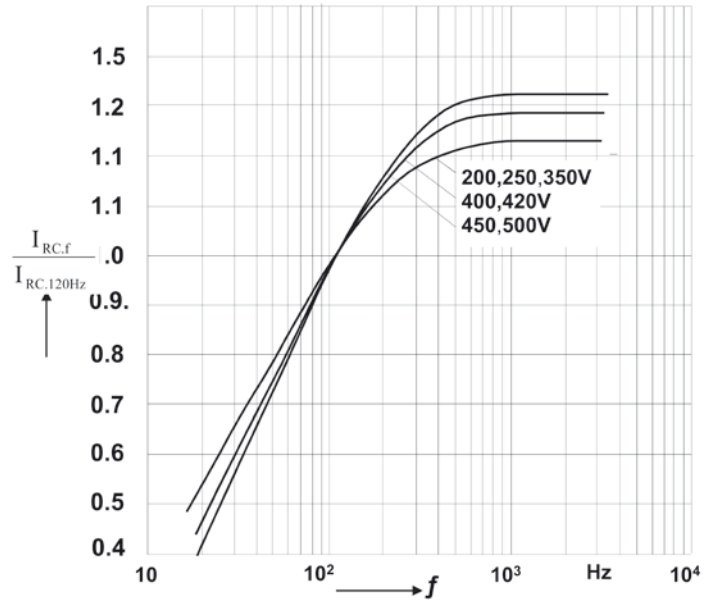

Frequency characteristics of ESR Typical behavior

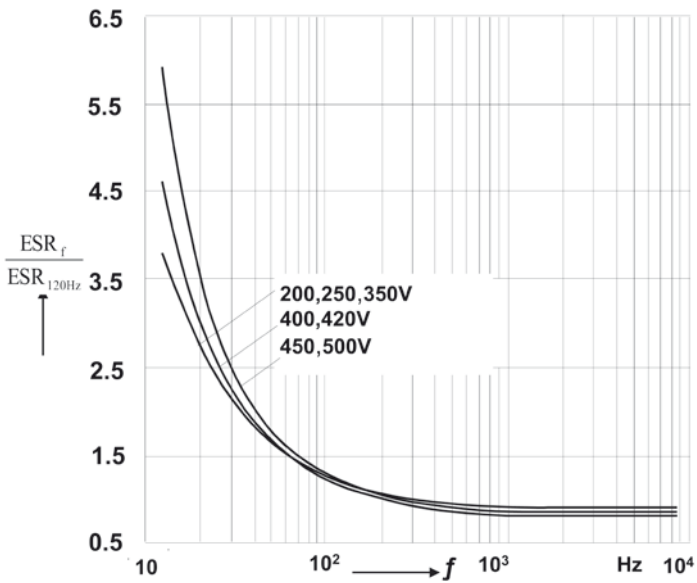

Impedance Z versus frequency f

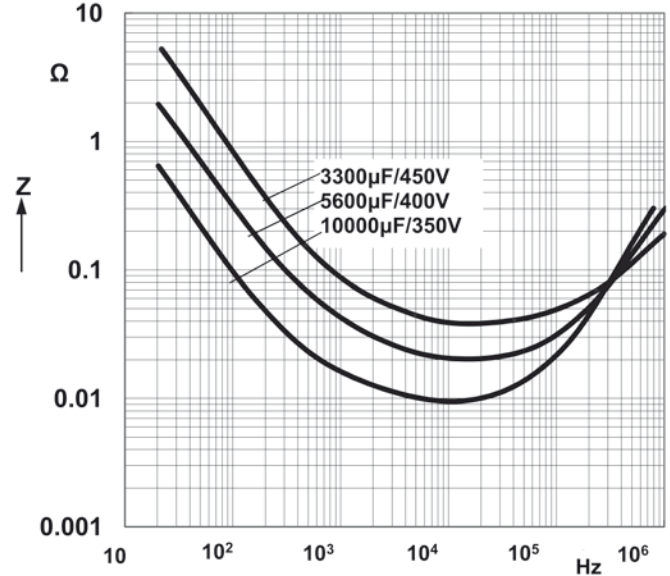

RX Series 85°C

Features

Extremely Long useful life

Applications

- ◆ Professional power supplies
- ◆ Frequency converters
- ◆ Uninterruptible power supplies

Features

- ◆ Long useful life
- ◆ High reliability
- ◆ High ripple current capability
- ◆ All-welded construction ensures reliable electrical contact
- ◆ Version with low-inductance design available
- ◆ Self-extinguishing electrolyte
- ◆ RoHS-compatible

Construction

- ◆ Charge-discharge proof, polar
- ◆ Aluminum case with insulating sleeve
- ◆ Poles with screw terminal connections
- ◆ Mounting with ring clips, clamps or threaded stud



Specifications

Item	Performance Characteristics					
Rated voltage V_R	160... 450 V DC					
Surge voltage V_S	1.15 V_R (for $V_R \leq 315$ V) or 1.10 V_R (for $V_R > 315$ V)					
Rated capacitance C_R	220 ... 47000 μ F					
Capacitance tolerance	$\pm 20\%$					
tan δ (at 20°C, 120Hz)	Less than the value under table(%)					
	ΦD	35	51	63.5	76.2	89
	WV	20	20	25	25	25
Leakage Current I_{leak} (20 °C, 5 min)	$I_{leak} \leq 0.3\mu A * (C*V)^{0.7} + 4\mu A$					
	Self-inductance ESL	d = 51 mm: approx. 17 nH d \geq 63.5 mm: approx. 20 nH Capacitors with low-inductance design: d \geq 63.5 mm: approx. 15 nH				
Useful life 85 °C; $V_R, I_{AC}^2 R$	> 20000 h	Requirements: $\Delta C/C \leq \pm 50\%$ of initial value ESR \leq 5 times initial specified limit $I_{leak} \leq$ initial specified limit Outlier Percentage: 0 %				
Voltage Endurance test 85 °C; V_R	5000 h	Post test requirements: $\Delta C/C \leq \pm 20\%$ of initial value ESR \leq 2 times initial specified limit $I_{leak} \leq$ initial specified limit Outlier Percentage: 0 %				
Vibration Resistance test	To IEC 60068-2-6, test Fc: Displacement amplitude 0.75 mm, frequency range 10 ... 55 Hz, acceleration max. 10 g, duration 3x2 h. Capacitor mounted by its body which is rigidly clamped to the work surface.					
Characteristics at low temperature	Max. impedance ratio at 120 Hz					
	V_R	≤ 400 V	≥ 450 V			
	$Z_{-25^\circ C} / Z_{20^\circ C}$	4	4			
	$Z_{-40^\circ C} / Z_{20^\circ C}$	10	12			
Sectional specification	IEC 60384-4 and JIS-C-5101					

Dimensional drawings

Ring clip/clamp mounting:

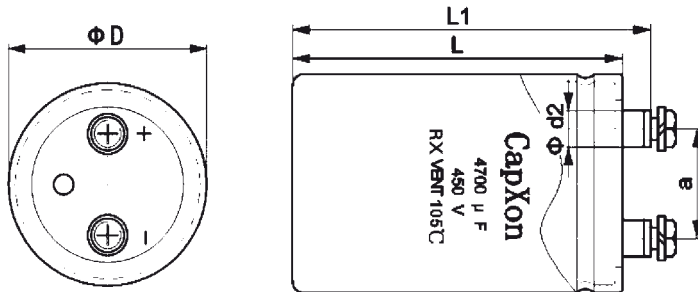

M5:Min.reach of screw = 8mm
M6:Min.reach of screw = 12mm

Dimensions

Terminal	Dimensions(mm) with insulating sleeve				
	$D \pm 2$	$L \pm 3$	$L_1 \pm 3$	$d_{2max.}$	$a \pm 0.5$
M5	35	50~120	56.5~126.5	10.3	12.7
M5	51	80~140	86.5~146.5	10.3	22
M5	63.5	80~140	86.5~146.5	10.3	28.6
M5	76.2/89	100~240	106.4~246.5	10.3	31.8
M6	76.2/89	100~240	106.4~246.5	17.5	31.8

Packing

Capacitor diameter d(mm)	length L(mm)	Packing units (pcs.)
35	≤70mm	120
	>70mm	60
42	≤70mm	120
	>70mm	60
51	≤70mm	70
	>70mm	35
63.5	all	24
76.2	all	15
89	all	12

Accessories

The following items are included in the delivery package, but are not fastened to the capacitors.

	Thread	Maximum torque
For terminal	M5	2 Nm
	M6	2.5 Nm

Case Size

φ DxL(mm)

WV(V) Cap(μF)	160		200		250	
	Size	Ripple	Size	Ripple	Size	Ripple
470					35×60	2.0
680			35×50	2.5	35×80	3.0
1000	35×60	3.3	35×60	3.5	35×100	4.4
1500	35×80	4.4	35×80	4.4	51×80	5.0
2200	35×100	5.8	35×120	6.3	51×100	7.0
			51×80	6.3		
3300	35×120	7.9	51×80	8.0	51×140	9.3
	51×80	7.9	51×100	8.4	63.5×100	8.8
4700	51×100	9.5	51×140	11.2	63.5×120	11.6
			63.5×100	10.9		
6800	51×140	13.5	63.5×120	13.5	76.2×120	14.5
	63.5×100	13.0				
10000	63.5×120	15.5	76.2×120	17.5	76.2×160	19.3
					89×140	20.0
15000	76.2×120	19.0	76.2×140	20.0	89×170	25.4
			76.2×160	21.5		
22000	76.2×140	24.2	76.2×160	27.0	89×220	29.8
	89×130	25.4	89×140	28.9		
33000	89×140	27.0				
47000	89×220	33.6				

Ripple Current(A,rms) at 85°C 120Hz

φ DxL(mm)

WV(V) Cap(μF)	350		400		450	
	Size	Ripple	Size	Ripple	Size	Ripple
220			35×50	2.5	35×50	2.5
330	35×60	2.8	35×60	3.0	35×60	3.0
470	35×80	4.0	35×80	5.8	35×80	6.0
680	35×100	5.8	35×120	6.8	35×120	7.4
			51×80	7.2	51×80	9.6
1000	35×120	7.7	51×80	8.2	51×80	8.4
	51×80	8.0			51×105	9.6
1500	51×80	10.0	51×105	11.2	51×120	12.4
	51×100	12.0	51×120	12.3		
2200	51×105	13.5	51×130	15.9	63.5×100	14.7
	51×120	14.5	63.5×100	14.5	63.5×120	16.1
	51×140	15.5				
2700	63.5×80	15.2	63.5×105	17.5	63.5×130	19.8
3300	63.5×100	17.5	63.5×130	20.1	63.5×145	23.1
	63.5×120	19.0	76.2×105	20.5	76.2×120	22.2
			76.2×120	21.4		
3900	63.5×120	20.0	76.2×120	22.8	76.2×145	26.3
4700	63.5×145	22.0	76.2×120	25.4	76.2×120	26.3
	76.2×105	22.0	76.2×130	26.3	76.2×160	29.8
	76.2×120	22.8				
5600	76.2×130	25.9	76.2×145	29.8	76.2×160	31.2
					89×145	35.0
6800	76.2×140	5.8	76.2×160	33.8	76.2×160	35.0
			89×145	35.0	76.2×220	38.5
					89×170	40.3
8200	76.2×160	35.0	89×160	38.5	89×180	42.0
	89×145	37.6				
10000	76.2×160	37.6	89×160	5.8	89×200	42.0
	76.2×190	40.3				
	89×140	40.3				
12000	76.2×220	48.0	89×180	49.0		
	89×170	50.0				
15000	89×190	52.5	89×200	54.3		
18000	89×220	59.5				

Ripple Current(A,rms) at 85°C 120Hz

Useful life

depending on ambient temperature T_a versus under ripple current operating conditions

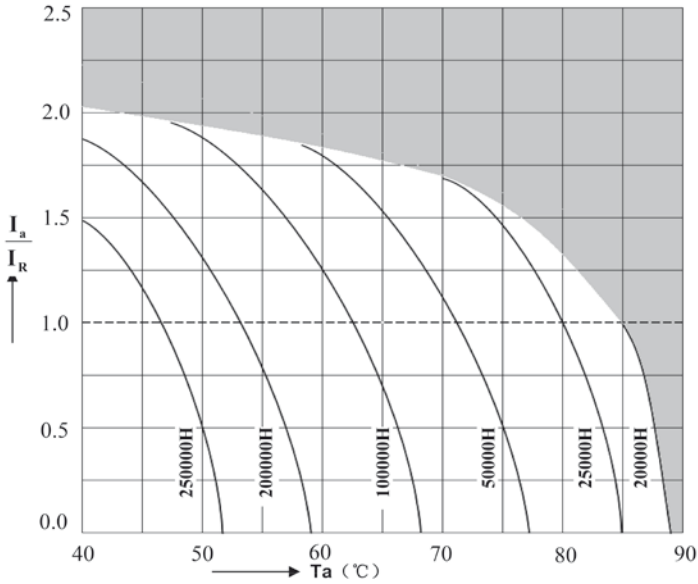

Frequency factor of permissible ripple current I_{RC} versus frequency f

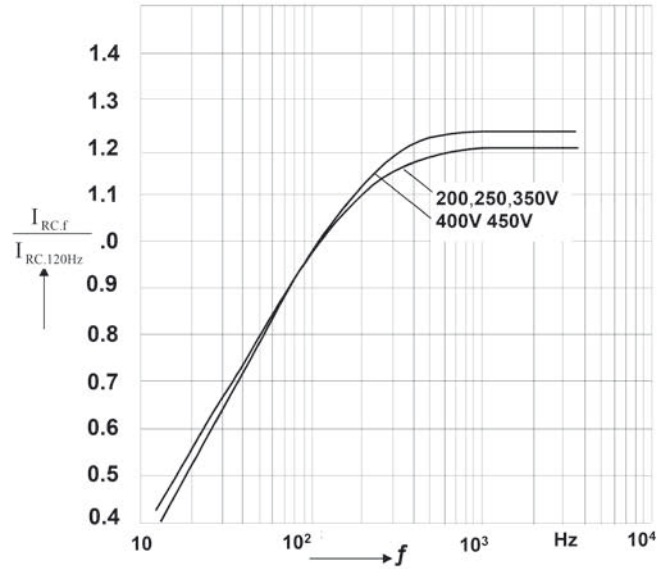

Frequency characteristics of ESR Typical behavior

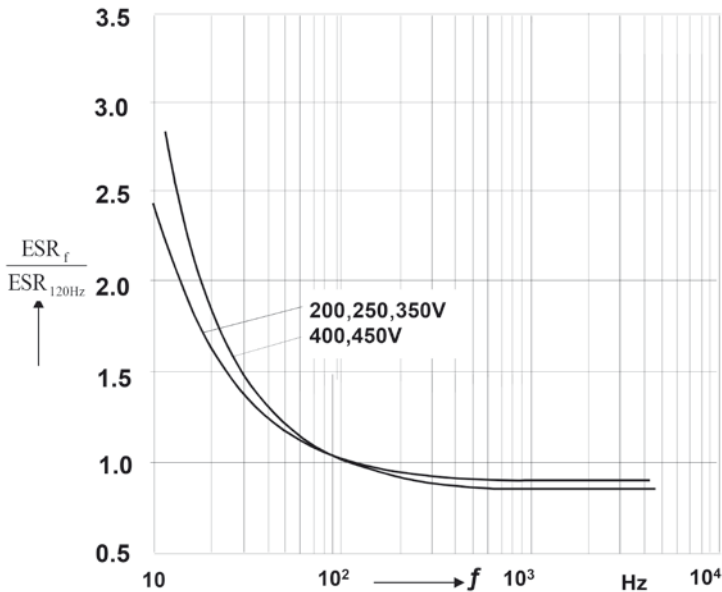

Impedance Z versus frequency f

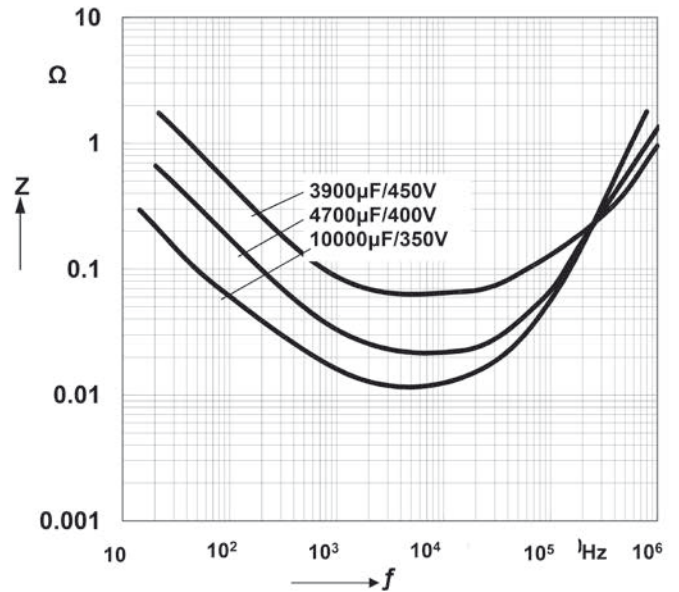

RU Series 85°C

Features

Extremely Long useful life

Applications

- ◆ Professional power supplies
- ◆ Frequency converters
- ◆ Uninterruptible power supplies

Features

- ◆ Long useful life
- ◆ High reliability
- ◆ High ripple current capability
- ◆ All-welded construction ensures reliable electrical contact
- ◆ Version with low-inductance design available
- ◆ Self-extinguishing electrolyte
- ◆ RoHS-compatible

Construction

- ◆ Charge-discharge proof, polar
- ◆ Aluminum case with insulating sleeve
- ◆ Poles with screw terminal connections
- ◆ Mounting with ring clips, clamps or threaded stud



Specifications

Item	Performance Characteristics					
Rated voltage V_R	350... 450 V DC					
Surge voltage V_S	1.15 V_R (for $V_R \leq 315$ V) or 1.10 V_R (for $V_R > 315$ V)					
Rated capacitance C_R	1000 ... 22000 μ F					
Capacitance tolerance	$\pm 20\%$					
tan δ (at 20°C, 120Hz)	Less than the value under table(%)					
	ΦD	35	51	63.5	76.2	89
	WV					
Leakage Current I_{leak} (20 °C, 5 min)	$I_{leak} \leq 0.3\mu A * (C * V)^{0.7} + 4\mu A$					
Self-inductance ESL	d = 51 mm: approx. 17 nH					
	d \geq 63.5 mm: approx. 20 nH					
	Capacitors with low-inductance design:					
	d \geq 63.5 mm: approx. 15 nH					
Useful life 85 °C; V_R, I_{AC^*R}	> 12000 h	Requirements: $\Delta C/C \leq \pm 50\%$ of initial value ESR \leq 5 times initial specified limit $I_{leak} \leq$ initial specified limit				
Voltage Endurance test 85 °C; V_R	2000 h	Post test requirements: $\Delta C/C \leq \pm 20\%$ of initial value ESR \leq 2 times initial specified limit $I_{leak} \leq$ initial specified limit				
Vibration Resistance test	To IEC 60068-2-6, test Fc:					
	Displacement amplitude 0.75 mm, frequency range 10 ... 55 Hz, acceleration max. 10 g, duration 3X2 h. Capacitor mounted by its body which is rigidly clamped to the work surface.					
Low Temperature Characteristics	Max. impedance ratio at 120 Hz					
	V_R	≤ 400 V	≥ 450 V			
	$Z_{-25^\circ C} / Z_{20^\circ C}$	3	4			
	$Z_{-40^\circ C} / Z_{20^\circ C}$	9	12			
Sectional specification	IEC 60384-4 and JIS-C-5101					

Dimensional drawings

Ring clip/clamp mounting:

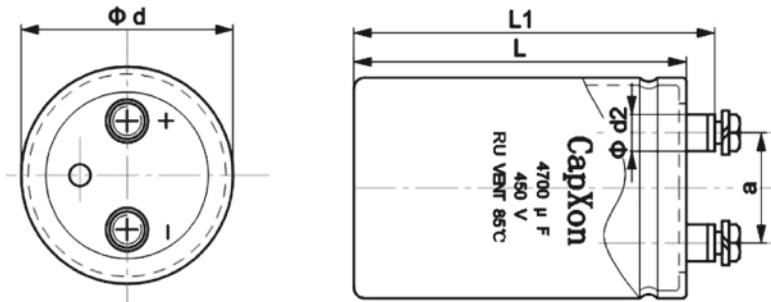

M5:Min.reach of screw = 8mm
M6:Min.reach of screw = 12mm

Dimensions

Terminal	Dimensions(mm) with insulating sleeve				
	D±2	L±3	L ₁ ±3	d ₂ max.	a±0.5
M5	35	50~120	56.5~126.5	10.3	12.7
M5	51	80~140	86.5~146.5	10.3	22
M5	63.5	80~140	86.5~146.5	10.3	28.6
M5	76.2/89	100~240	106.4~246.5	10.3	31.8
M6	76.2/89	100~240	106.4~246.5	17.5	31.8

Packing

Diameter D(mm)	Length L(mm)	Packing (pcs.)
35	≤70mm	120
	>70mm	60
42	≤70mm	120
	>70mm	60
51	≤70mm	70
	>70mm	35
63.5	all	24
76.2	all	15
89	all	12

Accessories

The following items are included in the delivery package, but are not fastened to the capacitors.

	Thread	Maximum torque
For terminal	M5	2 Nm
	M6	2.5 Nm

Case Size

φ DxL(mm)

WV(V) Cap(μF)	350		400		450	
	Size	Ripple	Size	Ripple	Size	Ripple
1000			51x80	4.6	51x80	4.8
					51x105	5.5
1500	51x80	5.7	51x80	6.0	51x100	6.5
			51x100	6.6	51x120	7.0
			51x105	6.6	63.5x80	6.7
2200	51x100	7.4	51x100	8.0	63.5x100	8.3
	51x105	7.6	51x120	8.6	63.5x105	8.5
	51x120	8.0	51x140	9.5	63.5x120	9.0
2700	63.5x80	9.0	63.5x105	9.5	76.2x105	10.5
3300	51x120	10.0	51x130	11.0	63.5x140	12.0
	51x140	10.5	63.5x100	11.0	76.2x100	12.0
	63.5x100	10.5	63.5x120	12.0	76.2x120	13.0
3900	63.5x105	12.0	76.2x100	14.0	76.2x120	13.5
			76.2x105	14.0	76.2x140	14.5
4700	63.5x120	13.5	76.2x100	14.5	76.2x120	15.0
	63.5x140	14.5	76.2x120	15.6	76.2x140	16.0
	76.2x100	13.5			76.2x160	17.0
5600	63.5x140	15.0	76.2x140	17.0	76.2x160	18.0
	76.2x105	15.0				
6800	76.2x120	17.0	76.2x140	19.0	76.2x160	19.0
	76.2x140	18.0	76.2x160	20.0		
	89x100	18.0				
8200	76.2x140	20.0	76.2x160	21.0	76.2x220	24.0
	76.2x160	21.0				
10000	76.2x160	24.5	76.2x190	25.0	76.2x220	27.0
	89x120	23.5	89x160	26.0	89x170	26.0
12000	76.2x180	28.0	89x160	28.0		
	76.2x220	30.0	89x220	32.0		
	89x145	28.0				
15000	76.2x220	33.0	76.2x230	32.0		
	89x160	32.0	89x180	32.0		
	89x220	36.0	89x220	35.0		
18000	89x220	38.0	89x240	37.0		
22000	89x230	40.0				

Ripple Current(A,rms) at 85°C 120Hz

Useful life

depending on ambient temperature T_a versus under ripple current operating conditions

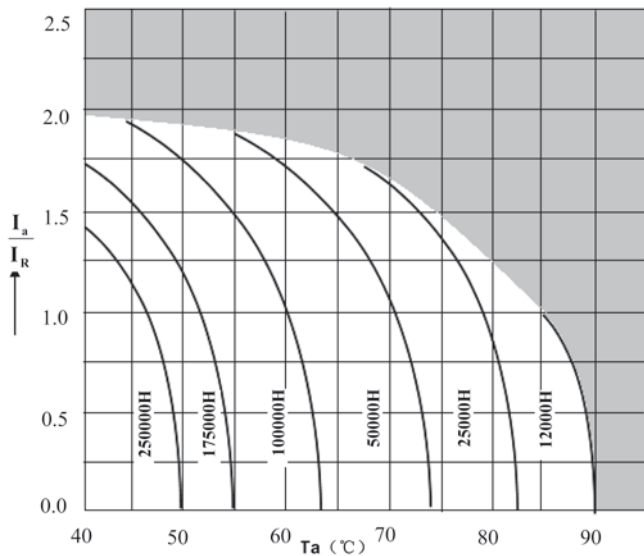

Frequency factor of permissible ripple current I_{RC} versus frequency f

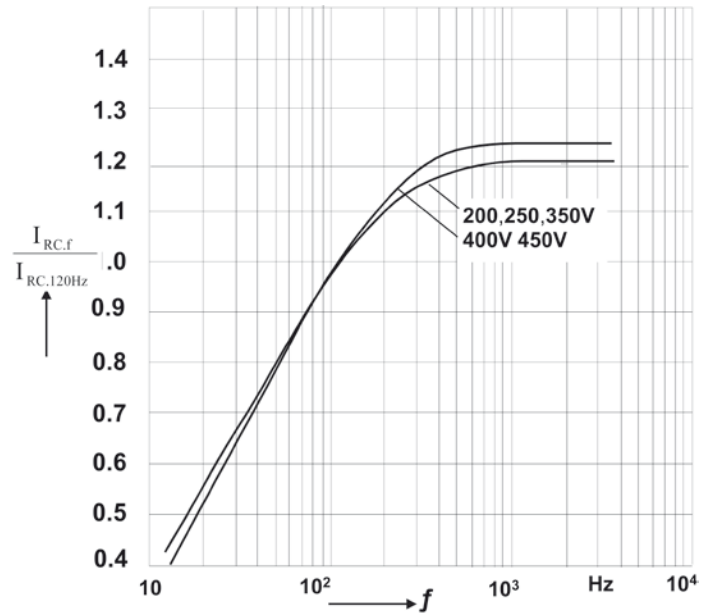

Frequency characteristics of ESR Typical behavior

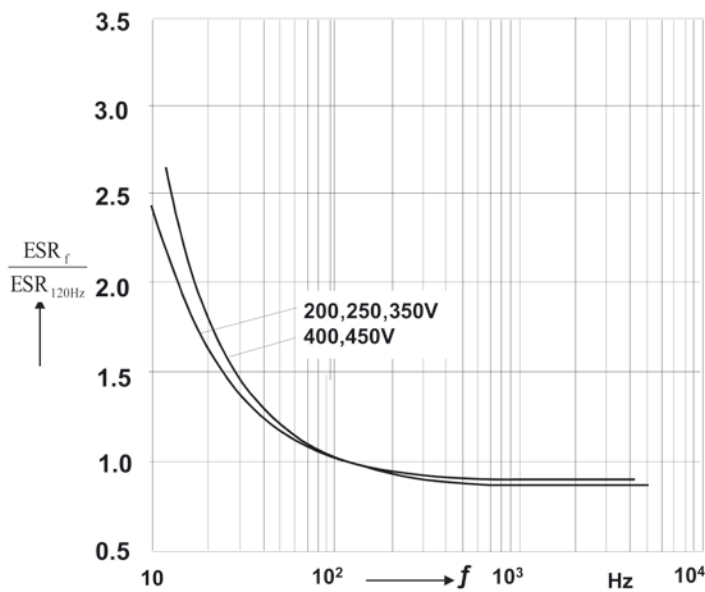

Impedance Z versus frequency f

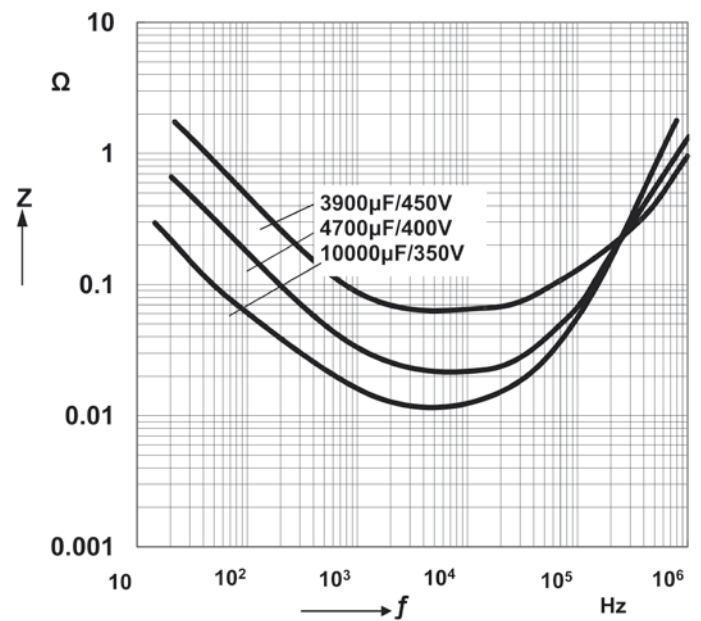

RJ Series 85°C

Features

Long useful life

Applications

- ◆ Professional power supplies
- ◆ Frequency converters
- ◆ Uninterruptible power supplies

Features

- ◆ Long useful life
- ◆ High reliability
- ◆ All-welded construction ensures reliable electrical contact
- ◆ Version with low-inductance design available
- ◆ Self-extinguishing electrolyte
- ◆ RoHS-compatible

Construction

- ◆ Charge-discharge proof, polar
- ◆ Aluminum case with insulating sleeve
- ◆ Poles with screw terminal connections
- ◆ Mounting with ring clips, clamps or threaded stud



Specifications

Item	Performance Characteristics					
Rated voltage V_R	350... 450 V DC					
Surge voltage V_S	1.15 V_R (for $V_R \leq 315$ V) or 1.10 V_R (for $V_R > 315$ V)					
Rated capacitance C_R	1500 ... 22000 μ F					
Capacitance tolerance	$\pm 20\%$					
tan δ (at 20°C · 120Hz)	Less than the value under table(%)					
	ΦD	35	51	63.5	76.2	89
	WV	15	15	20	20	20
		20	20	25	25	25
Leakage Current I_{leak} (20 °C, 5 min)	$I_{leak} \leq 0.3\mu A * (C*V)^{0.7} + 4\mu A$					
Self-inductance ESL	d = 51 mm: approx. 17 nH					
	d \geq 63.5 mm: approx. 20 nH					
	Capacitors with low-inductance design: d \geq 63.5 mm: approx. 15 nH					
Useful life 85 °C; $V_R I_{AC}^2 R$	> 10000 h	Requirements: $\Delta C/C \leq \pm 50\%$ of initial value ESR \leq 5 times initial specified limit $I_{leak} \leq$ initial specified limit				
Voltage Endurance test 85 °C; V_R	2000 h	Post test requirements: $\Delta C/C \leq \pm 20\%$ of initial value ESR \leq 2 times initial specified limit $I_{leak} \leq$ initial specified limit				
Vibration Resistance test	To IEC 60068-2-6, test Fc:					
	Displacement amplitude 0.75 mm, frequency range 10 ... 55 Hz, acceleration max. 10 g, duration 3X2 h. Capacitor mounted by its body which is rigidly clamped to the work surface.					
Low Temperature Characteristics	Max. impedance ratio at 120 Hz					
	V_R	≤ 400 V	≥ 450 V			
	$Z_{-25^\circ C} / Z_{20^\circ C}$	4	3			
	$Z_{-40^\circ C} / Z_{20^\circ C}$	16	12			
Sectional specification	IEC 60384-4 and JIS-C-5101					

Dimensional drawings

Ring clip/clamp mounting:

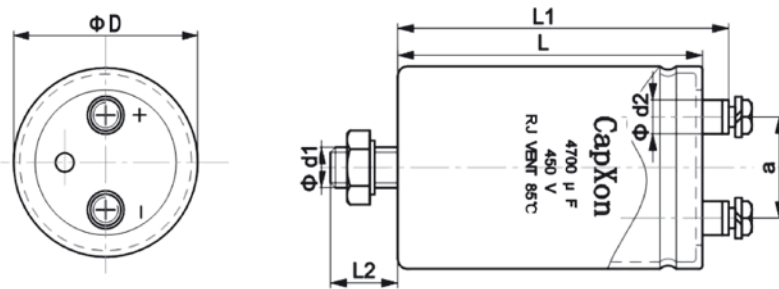

M5:Min.reach of screw = 8mm
M6:Min.reach of screw = 12mm

Dimensions

Terminal	Dimensions(mm) with insulating sleeve						
	$D \pm 2$	$L \pm 3$	$L_1 \pm 3$	$L_2 \pm 1$	d_1	$d_2 \text{ max.}$	$a \pm 0.5$
M5	63.5	80~140	86.5~146.5	16	M12	10.3	28.6
M5/M6	76.2/89	100~240	106.4~246.5	16	M12	10.3	31.8
M5/M6	76.2/89	100~240	106.4~246.5	16	M12	17.5	31.8

Packing

Diameter D(mm)	Length L(mm)	Packing (pcs.)
63.5	all	24
76.2	all	15
89	all	12

Accessories

The following items are included in the delivery package, but are not fastened to the capacitors.

	Thread	Maximum torque
For terminal	M5	2 Nm
	M6	2.5 Nm

Case Size

φ DxL(mm)

WV(V) Cap(μF)	350		400		450	
	Size	Ripple	Size	Ripple	Size	Ripple
1500					63.5x80	11.4
2200					63.5x100	12.5
					63.5x105	12.8
					63.5x120	13.5
2700	63.5x80	12.8	63.5x105	10.8	76.2x105	14.6
3300					63.5x120	15.0
	63.5x100	14.2	63.5x100	11.0	63.5x140	16.0
			63.5x120	12.0	76.2x120	17.7
3900	63.5x105	14.6	76.2x100	14.0	76.2x120	18.0
			76.2x105	14.3	76.2x140	19.0
4700	63.5x120	15.0	76.2x100	15.7	76.2x120	18.3
	63.5x140	15.5	76.2x120	17.0	76.2x140	19.6
	76.2x100	19.7			76.2x160	20.5
5600	63.5x140	21.5	76.2x140	18.8	76.2x160	21.0
6800	76.2x120	22.5	76.2x140	22.0	76.2x160	22.0
	76.2x140	24.0	76.2x160	23.0		
	89x100	23.0				
8200	76.2x160	26.0	76.2x160	23.5	76.2x220	25.6
10000	76.2x160	27.5	76.2x160	24.0	76.2x220	26.0
	89x120	26.0	89x130	25.0	89x170	26.0
12000	76.2x180	29.0	89x160	25.5		
	76.2x220	32.0	89x220	28.5		
15000	89x160	34.0	76.2x230	33.0		
	89x220	39.0	89x180	32.0		
			89x220	35.0		
18000	89x220	40.0	89x240	38.0		
22000	89x230	42.0				

Ripple Current(A,rms) at 85°C 120Hz

Useful life

depending on ambient temperature T_a versus under ripple current operating conditions

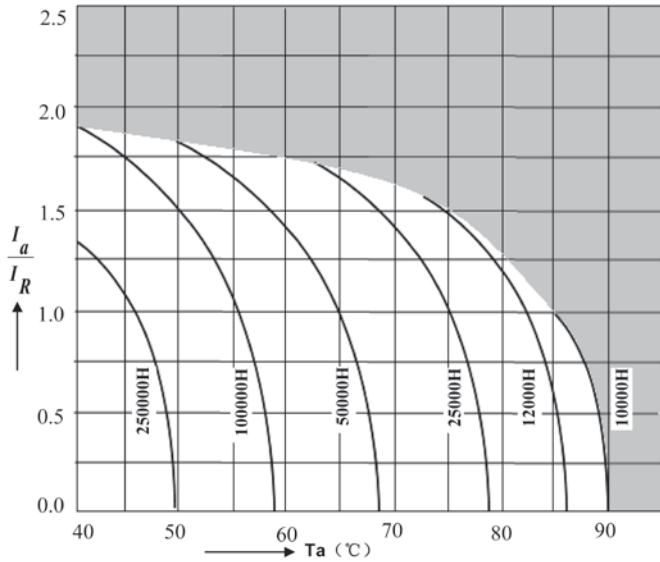

Frequency factor of permissible ripple current I_{RC} versus frequency f

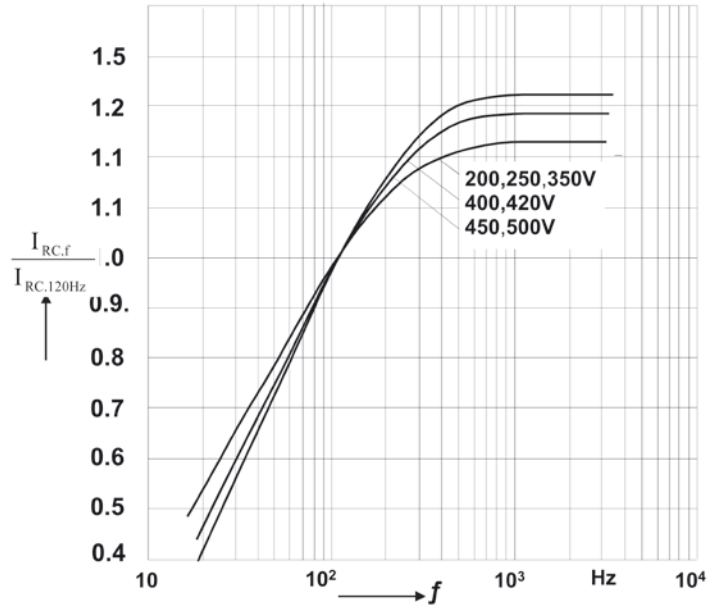

Frequency characteristics of ESR Typical behavior

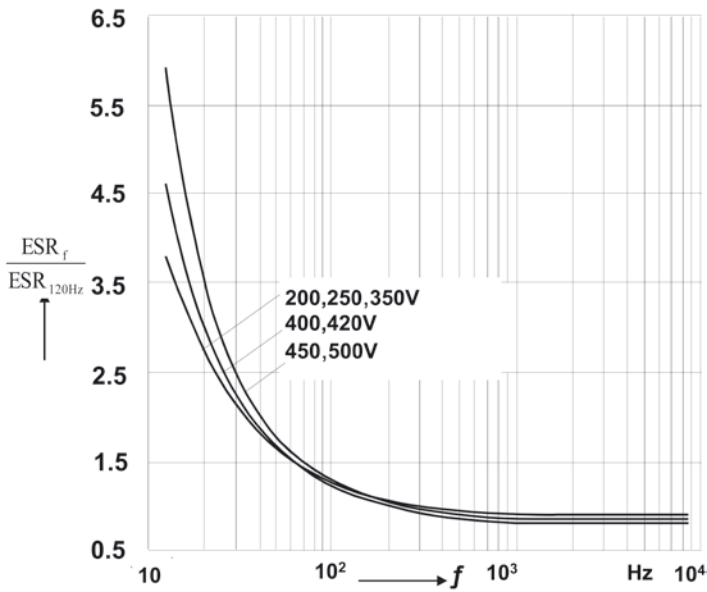

Impedance Z versus frequency f

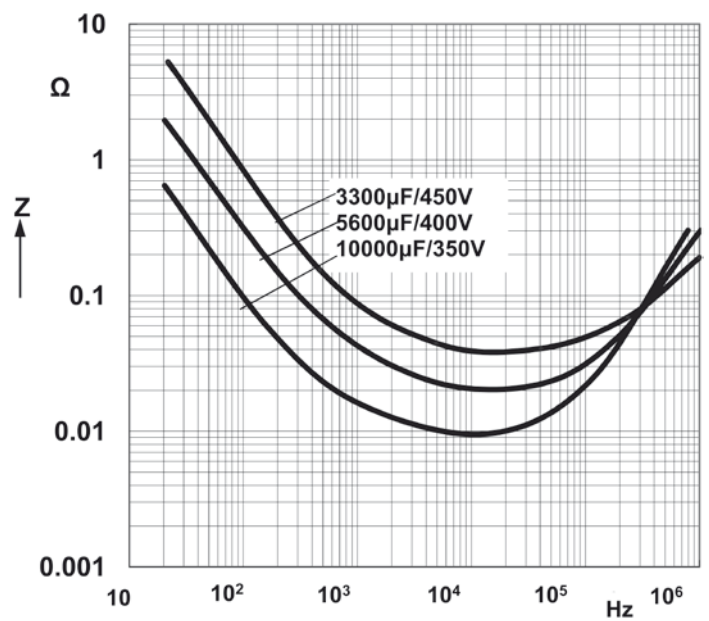

RY Series 85°C

Features

Extremely Long useful life

Applications

- ◆ Professional power supplies
- ◆ Frequency converters
- ◆ Uninterruptible power supplies

Features

- ◆ Long useful life
- ◆ High reliability
- ◆ High ripple current capability
- ◆ All-welded construction ensures reliable electrical contact
- ◆ Version with low-inductance design available
- ◆ Self-extinguishing electrolyte
- ◆ RoHS-compatible

Construction

- ◆ Charge-discharge proof, polar
- ◆ Aluminum case with insulating sleeve
- ◆ Poles with screw terminal connections
- ◆ Mounting with ring clips, clamps or threaded stud



Specifications

Item	Performance Characteristics					
Rated voltage V_R	350... 450 V DC					
Surge voltage V_S	1.15 V_R (for $V_R \leq 315$ V) or 1.10 V_R (for $V_R > 315$ V)					
Rated capacitance C_R	1500 ... 22000 μ F					
Capacitance tolerance	$\pm 20\%$					
tan δ (at 20 °C, 120Hz)	Less than the value under table(%)					
	ΦD	35	51	63.5	76.2	89
	160~250	15	15	20	20	20
	350~450	20	20	25	25	25
Leakage Current I_{leak} (20 °C, 5 min)	$I_{leak} \leq 0.3\mu A * (C*V)^{0.7} + 4\mu A$					
Self-inductance ESL	d = 51 mm: approx. 17 nH					
	d \geq 63.5 mm: approx. 20 nH					
	Capacitors with low-inductance design:					
	d \geq 63.5 mm: approx. 15 nH					
Useful life 85 °C; V_R, I_{AC}^R	> 12000 h	Requirements: $\Delta C/C \leq \pm 50\%$ of initial value ESR \leq 5 times initial specified limit $I_{leak} \leq$ initial specified limit				
Voltage Endurance test 85 °C; V_R	2000 h	Post test requirements: $\Delta C/C \leq \pm 20\%$ of initial value ESR \leq 2 times initial specified limit $I_{leak} \leq$ initial specified limit				
Vibration Resistance test	To IEC 60068-2-6, test Fc:					
	Displacement amplitude 0.75 mm, frequency range 10 ... 55 Hz, acceleration max. 10 g, duration 3X2 h. Capacitor mounted by its body which is rigidly clamped to the work surface.					
Low Temperature Characteristics	Max. impedance ratio at 120 Hz					
	V_R	≤ 400 V		≥ 450 V		
	$Z_{-25^\circ C} / Z_{20^\circ C}$	3		4		
	$Z_{-40^\circ C} / Z_{20^\circ C}$	9		12		
Sectional specification	IEC 60384-4 and JIS-C-5101					

Dimensional drawings

Ring clip/clamp mounting:

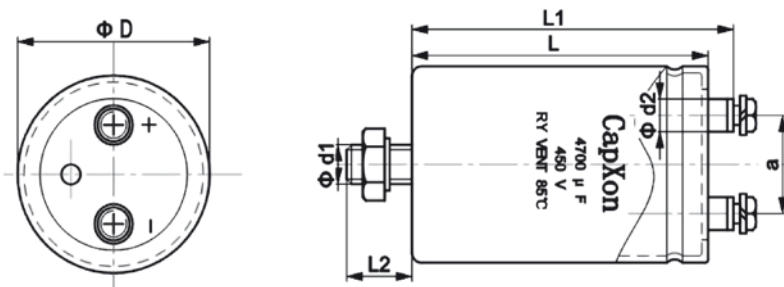

M5:Min.reach of screw = 8mm
M6:Min.reach of screw = 12mm

Dimensions

Terminal	Dimensions(mm) with insulating sleeve						
	$D \pm 2$	$L \pm 3$	$L_1 \pm 3$	$L_2 \pm 1$	d_1	$d_2 \text{ max.}$	$a \pm 0.5$
M5	63.5	80~140	86.5~146.5	16	M12	10.3	28.6
M5	76.2/89	100~240	106.4~246.5	16	M12	10.3	31.8
M6	76.2/89	100~240	106.4~246.5	16	M12	17.5	31.8

Packing

Diameter D(mm)	Length L(mm)	Packing (pcs.)
63.5	all	24
76.2	all	15
89	all	12

Accessories

The following items are included in the delivery package, but are not fastened to the capacitors.

	Thread	Maximum torque
For terminal	M5	2 Nm
	M6	2.5 Nm

Case Size

φ DxL(mm)

WV(V) Cap(μF)	350		400		450	
	Size	Ripple	Size	Ripple	Size	Ripple
1500					63.5x80	13.0
2200					63.5x100	14.0
					63.5x105	15.0
					63.5x120	16.0
2700	63.5x80	16.0	63.5x105	17.0	76.2x105	18.0
3300			63.5x100	20.0	63.5x140	23.0
	63.5x100	19.0	63.5x120	21.5	76.2x100	23.0
					76.2x120	25.0
3900	63.5x105	21.0	76.2x100	23.0	76.2x120	24.0
			76.2x105	23.0	76.2x140	25.0
4700	63.5x120	22.0	76.2x100	26.0	76.2x120	27.0
	63.5x140	23.5	76.2x120	28.0	76.2x140	28.0
	76.2x100	24.0			76.2x160	29.0
5600	63.5x140	28.0	76.2x140	30.0	76.2x160	31.5
	76.2x105	30.0				
6800	76.2x120	31.0	76.2x140	33.0	76.2x160	32.0
	76.2x140	33.0	76.2x160	35.0		
	89x100	34.0				
8200	76.2x140	36.0	76.2x160	34.0	76.2x220	36.0
	76.2x160	38.0				
10000	76.2x160	42.0	76.2x190	38.0	76.2x220	40.0
	89x120	42.0	89x160	39.0	89x170	40.0
12000	76.2x180	45.0	89x160	41.0		
	76.2x220	49.0	89x220	46.0		
	89x145	51.0				
15000	76.2x220	53.0	76.2x230	48.0		
	89x160	53.0	89x180	52.0		
	89x220	55.0	89x220	57.0		
18000	89x220	58.0	89x240	60.0		
22000	89x230	60.0				

Ripple Current(A,rms) at 85°C 120Hz

Useful life

depending on ambient temperature T_a versus under ripple current operating conditions

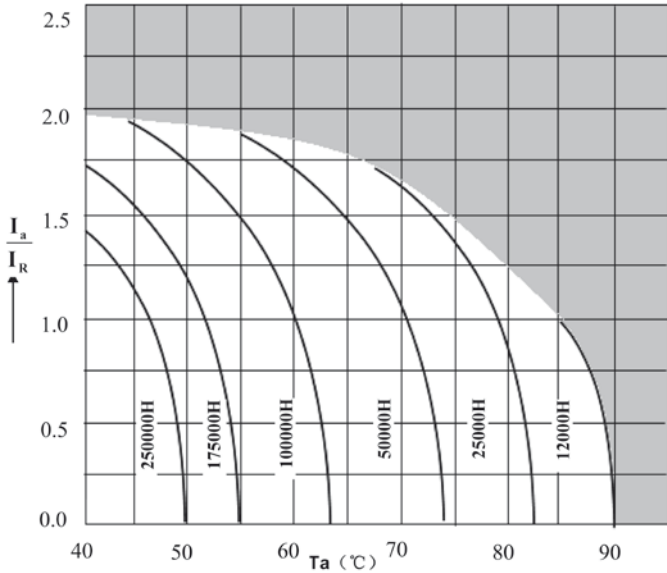

Frequency factor of permissible ripple current I_{RC} versus frequency f

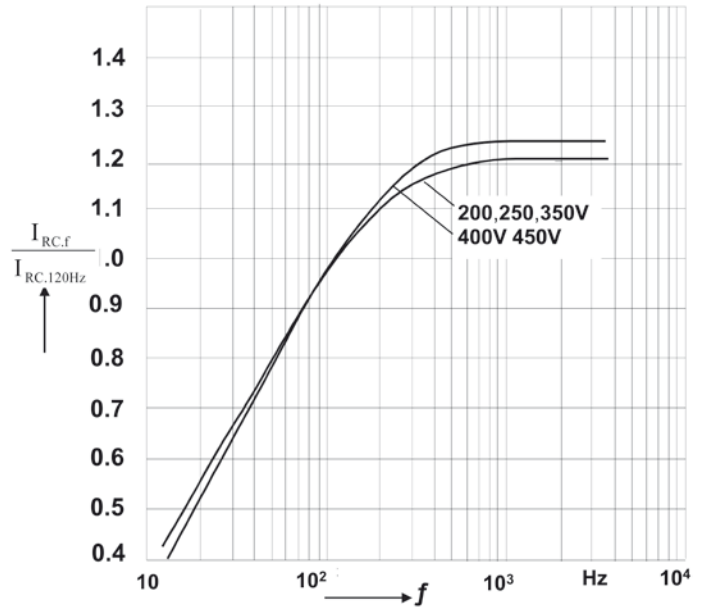

Frequency characteristics of ESR Typical behavior

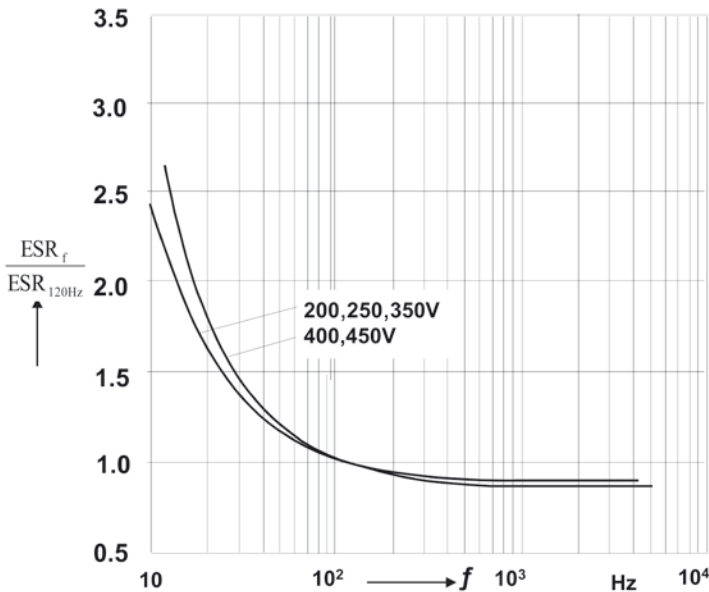

Impedance Z versus frequency f

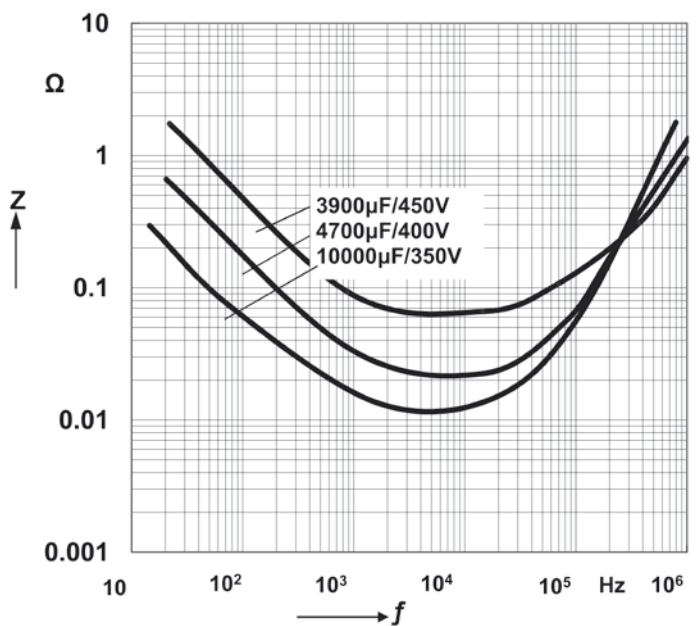

RK Series 105°C

Features

General capacitors

Applications

- ◆ Frequency converters
- ◆ Professional power supplies
- ◆ Uninterruptible power supplies

Features

- ◆ Wide temperature range
- ◆ All-welded construction ensures reliable electrical contact
- ◆ Self-extinguishing electrolyte
- ◆ RoHS-compatible

Construction

- ◆ Charge-discharge proof, polar
- ◆ Aluminum case with insulating sleeve
- ◆ Poles with screw terminal connections
- ◆ Mounting with ring clips, clamps or threaded stud



Specifications

Item	Performance Characteristics					
Rated voltage V_R	16... 100 V DC					
Surge voltage V_S	1.15 V_R (for $V_R \leq 315$ V) or 1.10 V_R (for $V_R > 315$ V)					
Rated capacitance C_R	1500 ... 1000000 μ F					
Capacitance tolerance	$\pm 20\%$					
$\tan \delta$ (at 20 °C , 120Hz)	Less than the value under table(%)					
	Φ D	35	51	63.5	76.2	89
	WV					
	16	60	70	80	120	140
	25	40	50	70	80	100
	35	30	50	60	70	90
	50	25	30	50	60	80
	63	20	25	30	40	60
Leakage Current I_{leak} (20 °C, 5 min)	$I_{leak} \leq 0.3\mu A * (C*V)^{0.7} + 4\mu A$					
	Endurance test 105 °C; V_R	2000 h	Requirements: $\Delta C/C \leq \pm 20\%$ of initial value ESR ≤ 2 times initial specified limit $I_{leak} \leq$ initial specified limit			
Vibration Resistance test	To IEC 60068-2-6, test Fc: Displacement amplitude 0.75 mm, frequency range 10 ... 55 Hz, acceleration max. 10 g, duration 3X2 h. Capacitor mounted by its body which is rigidly clamped to the work surface.					
Low Temperature Characteristics	Max. impedance ratio at 120 Hz					
	$Z_{-25^\circ C} / Z_{20^\circ C}$	3				
	$Z_{-40^\circ C} / Z_{20^\circ C}$	12				
Sectional specification	IEC 60384-4 and JIS-C-5101					

Dimensional drawings

Ring clip/clamp mounting:

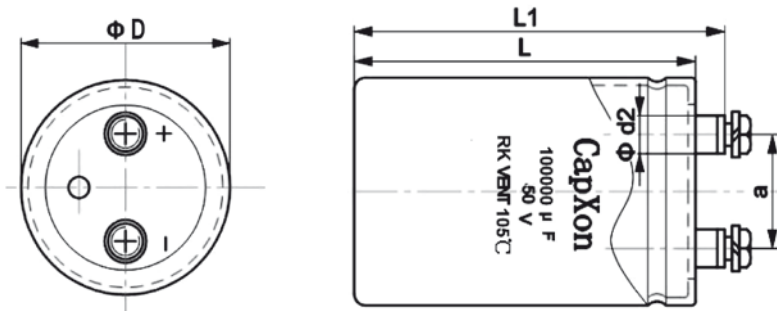

M5:Min.reach of screw = 8mm
M6:Min.reach of screw = 12mm

Dimensions

Terminal	Dimensions(mm) with insulating sleeve				
	D±2	L±3	L ₁ ±3	d ₂ max.	a±0.5
M5	35	50~120	56.5~126.5	10.3	12.7
M5	51	80~140	86.5~146.5	10.3	22
M5	63.5	80~140	86.5~146.5	10.3	28.6
M5	76.2/89	100~240	106.4~246.5	10.3	31.8
M6	76.2/89	100~240	106.4~246.5	17.5	31.8

Packing

Diameter D(mm)	Length L(mm)	Packing (pcs.)
35	≤70mm	120
	>70mm	60
42	≤70mm	120
	>70mm	60
51	≤70mm	70
	>70mm	35
63.5	all	24
76.2	all	15
89	all	12
100	all	6

Accessories

The following items are included in the delivery package, but are not fastened to the capacitors.

	Thread	Maximum torque
For terminal	M5	2 Nm
	M6	2.5 Nm

Case Size

WV(V) Cap(μF)		16		25		35		50		φ DxL(mm)
		Size	Ripple	Size	Ripple	Size	Ripple	Size	Ripple	
6800								35x50		3.1
10000						35x60	3.5	35x60		4.0
15000				35x50	5.3	35x80	4.8	35x80		5.5
22000	35x60	4.9	35x60	6.5	35x100	8.8	35x120	51x80		10.0
33000	35x80	6.7	35x80	8.8	35x120	11.0	51x80	51x100		13.0
			35x100	9.7						
47000	35x100	8.8	35x105	11.0	51x100	14.0	51x120	63.5x100		15.8
			35x120	11.7						16.5
			51x80	12.0						
68000	51x80	9.5	51x80	13.0	51x120	16.5	51x120	63.5x100		18.0
			51x100	14.3						
100000	51x100	12.5	51x105	15.0	63.5x120	20.0	63.5x120	76.2x120		23.0
			51x120	16.0						
			63.5x100	16.7						
150000	51x120	15.5	63.5x105	18.0	76.2x120	23.0	76.2x120	76.2x140		25.0
	51x140	17.6	63.5x120	19.0						
220000	63.5x120	18.0	76.2x105	20.0	76.2x160	27.0	76.2x160	89X160		30.0
			76.2x120	21.2	89X140	27.5	89X140			
330000	76.2x120	19.1	76.2x145	24.0	89X160	30.0	89X160	89X220		35.0
			76.2x160	25.0						
			89X140	26.0						
470000	76.2x160	25.5	89X160	28.0	89X220	35.0	89X220			
	89X140	26.0								
680000	89X160	27.0	89X220	33.0						
1000000	89X220	28.5								

Ripple Current(A rms) at 105°C /120Hz

WV(V) Cap(μF)		63		80		100	
		Size	Ripple	Size	Ripple	Size	Ripple
1500						35x60	3.5
2200						35x80	4.7
3300						35x80	5.7
						35x100	6.3
4700				35x60	5.3	35x100	3.8
						35x105	7.5
						51x80	4.3
6800	35x60	5.3	35x80	7.0	51x80	8.7	8.7
	35x80	6.0			51x100	9.5	9.5
10000	35x80	7.2	35x100	8.2	51x100	10.5	10.5
	35x105	8.1	51x80	9.0	51x105	11.0	11.0
					51x140	12.5	12.5
15000	35x120	9.0	51x80	10.0	63.5x100	14.5	14.5
	51x80	9.5			63.5x105	15.0	15.0
					63.5x120	16.0	16.0
22000	51x80	10.5	51x100	13.0	76.2x100	16.5	16.5
	51x105	12.0			76.2x105	17.0	17.0
					76.2x120	18.0	18.0
33000	51x120	14.0	51x140	16.0	76.2x140	20.5	20.5
	63.5x100	14.5	76.2x100	17.0	76.2x145	21.0	21.0
	63.5x105	15.0					
47000	63.5x100	16.6	63.5x140	19.0	76.2x160	23.0	23.0
	63.5x105	17.0	76.2x120	19.0	89X140	23.5	23.5
68000	63.5x140	19.5	76.2x140	22.0	89X160	25.5	25.5
	76.2x105	19.0					
	76.2x120	20.0					
100000	76.2x140	22.5	89X160	26.0	89X230	30.0	30.0
	76.2x145	23.0					
150000	89X160	27.0					

Ripple Current(A rms) at 105°C /120Hz

RL Series 105°C

Features

Long Endurance

Applications

- ◆ Frequency converters
- ◆ Professional power supplies
- ◆ Uninterruptible power supplies

Features

- ◆ Outstanding reliability
- ◆ Wide temperature range
- ◆ Version with low-inductance design available
- ◆ All-welded construction ensures reliable electrical contact
- ◆ Self-extinguishing electrolyte
- ◆ RoHS-compatible

Construction

- ◆ Charge-discharge proof, polar
- ◆ Aluminum case with insulating sleeve
- ◆ Poles with screw terminal connections
- ◆ Mounting with ring clips, clamps or threaded stud



Specifications

Item	Performance Characteristics					
Rated voltage V_R	350... 450 V DC					
Surge voltage V_S	1.15 V_R (for $V_R \leq 315$ V) or 1.10 V_R (for $V_R > 315$ V)					
Rated capacitance C_R	680 ... 15000 μ F					
Capacitance tolerance	$\pm 20\%$					
tan δ (at 20 °C , 120Hz)	Less than the value under table(%)					
	ΦD	35	51	63.5	76.2	89
	WV	20	20	25	25	25
Leakage Current I_{leak} (20 °C, 5 min)	$I_{leak} \leq 0.3\mu A * (C*V)^{0.7} + 4\mu A$					
	Endurance test 105 °C; V_R	5000 h	Requirements: $\Delta C/C \leq \pm 20\%$ of initial value ESR ≤ 2 times initial specified limit $I_{leak} \leq$ initial specified limit			
Vibration Resistance test	To IEC 60068-2-6, test Fc:					
	Displacement amplitude 0.75 mm, frequency range 10 ... 55 Hz, acceleration max. 10 g, duration 3X2 h. Capacitor mounted by its body which is rigidly clamped to the work surface.					
Low Temperature Characteristics	Max. impedance ratio at 120 Hz					
	$Z_{-25^\circ C} / Z_{20^\circ C}$	3				
	$Z_{-40^\circ C} / Z_{20^\circ C}$	12				
Sectional specification	IEC 60384-4 and JIS-C-5101					

Dimensional drawings

Ring clip/clamp mounting:

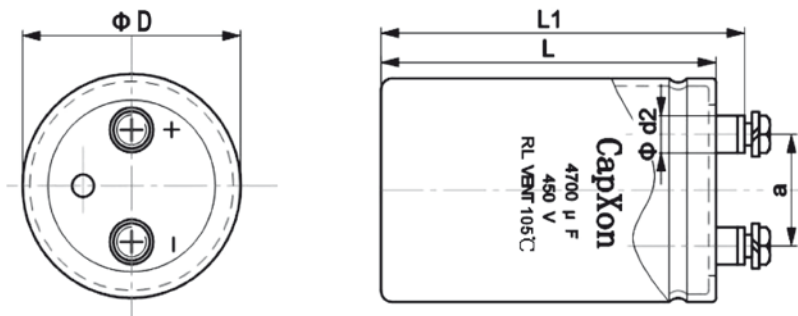

M5:Min.reach of screw = 8mm
M6:Min.reach of screw = 12mm

Dimensions

Terminal	Dimensions(mm) with insulating sleeve				
	$D \pm 2$	$L \pm 3$	$L_1 \pm 3$	$d_2 \text{max.}$	$a \pm 0.5$
M5	35	50~120	56.5~126.5	10.3	12.7
M5	51	80~140	86.5~146.5	10.3	22
M5	63.5	80~140	86.5~146.5	10.3	28.6
M5	76.2/89	100~240	106.4~246.5	10.3	31.8
M6	76.2/89	100~240	106.4~246.5	17.5	31.8

Packing

Diameter d(mm)	Length L(mm)	Packing (pcs.)
35	$\leq 70\text{mm}$	120
	$> 70\text{mm}$	60
42	$\leq 70\text{mm}$	120
	$> 70\text{mm}$	60
51	$\leq 70\text{mm}$	70
	$> 70\text{mm}$	35
63.5	all	24
76.2	all	15
89	all	12

Accessories

The following items are included in the delivery package, but are not fastened to the capacitors.

	Thread	Maximum torque
For terminal	M5	2 Nm
	M6	2.5 Nm

Case Size

WV(V) Cap(μF)		350		400		450	
		Size	Ripple	Size	Ripple	Size	Ripple
680	51x80	4.0					
1000	51x80	6.5	51x80	6.6	63.5x115	12.1	
1200	51x80	6.8	51x80	7.0	63.5x120	12.3	
1500	51x100	8.6	51x120	9.0	63.5x120	12.5	
1800	51x120	9.2	51x140	10.8	63.5x120	13.0	
			63.5x100	10.8			
2200	51x120	11.0	63.5x110	11.6	76.2x100	14.0	
2700	63.5x100	12.5	63.5x115	13.7	76.2x110	16.9	
3300	63.5x110	14.5	63.5x130	16.1	76.2x130	18.0	
3900	63.5x130	16.5	63.5x150	17.9	76.2x140	19.0	
			76.2x110	18.2	89x120	19.5	
4700	63.5x150	20.0	76.2x130	21.2	76.2x140	22.6	
	76.2x120	20.0			89x140	24.5	
5600	63.5x170	22.5	76.2x150	24.3	76.2x160	25.2	
	76.2x130	22.5			89x150	26.5	
6800	76.2x150	26.0	89x150	27.1	89x160	26.0	
8200	76.2x170	30.0	89x170	29.8	89x190	28.3	
	89x150	29.0					
10000	89x150	32.5					
12000	89x190	36.0					
15000	89x220	43.0					

φ DxL(mm)

Ripple Current(A,rms) at 105°C 120Hz

RM Series 105°C

Features

Long useful life

Applications

- ◆ Frequency converters
- ◆ Professional power supplies
- ◆ Hybrid electric vehicles(HEV)
- ◆ Traction

Construction

- ◆ Charge-discharge proof, polar
- ◆ Aluminum case with insulating sleeve
- ◆ Poles with screw terminal connections
- ◆ Mounting with ring clips, clamps or threaded stud



Features

- ◆ High reliability ◆ long useful life
- ◆ Extremely high ripple current capability
- ◆ Wide temperature range
- ◆ All-welded construction ensures reliable electrical contact
- ◆ Low-inductance design
- ◆ Self-extinguishing electrolyte
- ◆ RoHS-compatible

Specifications

Item	Performance Characteristics					
Rated voltage V_R	160... 450 V DC					
Surge voltage V_S	1.15 V_R (for $V_R \leq 315$ V) or 1.10 V_R (for $V_R > 315$ V)					
Rated capacitance C_R	220 ...47000 μ F					
Capacitance tolerance	$\pm 20\%$					
tan δ (at 20°C · 120Hz)	Less than the value under table(%)					
	ΦD	35	51	63.5	76.2	89
	WV	15	15	20	20	20
Leakage Current I_{leak} (20 °C, 5 min)	$I_{leak} \leq 0.3\mu A * (C*V)^{0.7} + 4\mu A$					
Self-inductance ESL	d = 51 mm: approx. 16 nH					
	d \geq 63.5 mm: approx. 18 nH					
	Capacitors with low-inductance design: d \geq 63.5 mm: approx. 14 nH					
Useful life 105 °C; V_R, I_{AC1R}	> 6000 h	Requirements: $\Delta C/C \leq \pm 40\%$ of initial value ESR \leq 4 times initial specified limit $I_{leak} \leq$ initial specified limit				
Voltage Endurance test 105 °C; V_R	2000 h	Post test requirements: $\Delta C/C \leq \pm 20\%$ of initial value ESR \leq 2 times initial specified limit $I_{leak} \leq$ initial specified limit				
Vibration Resistance test	To IEC 60068-2-6, test Fc:					
	Displacement amplitude 0.75 mm, frequency range 10 ... 55 Hz, acceleration max. 10 g, duration 3X2 h. Capacitor mounted by its body which is rigidly clamped to the work surface.					
Low Temperature Characteristics	Max. impedance ratio at 120 Hz					
	V_R	≤ 400 V	≥ 450 V			
	$Z_{-25^\circ C} / Z_{20^\circ C}$	4	4			
	$Z_{-40^\circ C} / Z_{20^\circ C}$	10	10			
Sectional specification	IEC 60384-4 and JIS-C-5101					

Dimensional drawings

Ring clip/clamp mounting:

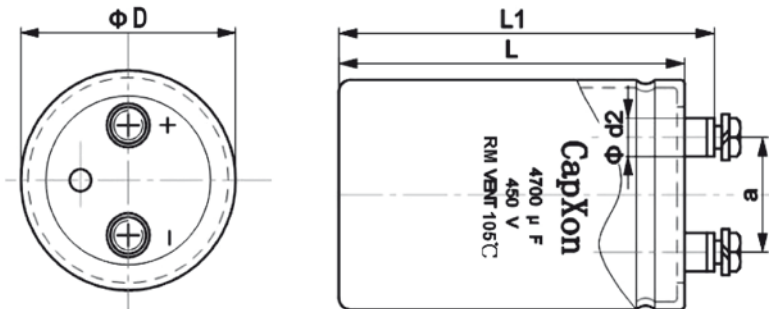

M5:Min.reach of screw = 8mm
M6:Min.reach of screw = 12mm

Dimensions

Terminal	Dimensions(mm) with insulating sleeve				
	$D \pm 2$	$L \pm 3$	$L_1 \pm 3$	$d_2 \text{max.}$	$a \pm 0.5$
M5	35	50~120	56.5~126.5	10.3	12.7
M5	51	80~140	86.5~146.5	10.3	22
M5	63.5	80~140	86.5~146.5	10.3	28.6
M5	76.2/89	100~240	106.4~246.5	10.5	31.8
M6	76.2/89	100~240	106.4~246.5	17.5	31.8

Packing

Diameter D(mm)	Length L(mm)	Packing (pcs.)
35	$\leq 70\text{mm}$	120
	$> 70\text{mm}$	60
42	$\leq 70\text{mm}$	120
	$> 70\text{mm}$	60
51	$\leq 70\text{mm}$	70
	$> 70\text{mm}$	35
63.5	all	24
76.2	all	15
89	all	12

Accessories

The following items are included in the delivery package, but are not fastened to the capacitors.

	Thread	Maximum torque
For terminal	M5	2 Nm
	M6	2.5 Nm

Case Size

φ DxDL(mm)

WV(V) Cap(μF)	160		200		250	
	Size	Ripple	Size	Ripple	Size	Ripple
470					35×60	1.1
680			35×50	1.3	35×80	1.5
1000	35×60	1.7	35×60	1.8	35×100	2.1
1500	35×80	2.1	35×80	2.3	51×80	2.6
2200	35×100	3.0	35×120	3.3	51×100	3.5
			51×80	3.3		
3300	35×120	4.0	51×80	4.1	51×140	4.8
	51×80	4.0	51×100	4.2	63.5×100	4.6
4700	51×100	5.0	51×140	5.8	63.5×120	6.0
			63.5×100	5.6		
6800	51×140	7.0	63.5×120	7.0	76.2×120	7.5
	63.5×100	6.8				
10000	63.5×120	7.9	76.2×120	9.0	76.2×160	10.0
					89×140	10.3
15000	76.2×120	9.8	76.2×140	10.5	89×170	13.0
			76.2×160	11.0		
22000	76.2×140	12.5	76.2×160	14.0	89×220	15.5
	89×130	13.2	89×140	15.0		
33000	89×140	14.0				
47000	89×220	17.5				

Ripple Current(A,rms) at 105°C 120Hz

WV(V) Cap(μF)	350		400		450	
	Size	Ripple	Size	Ripple	Size	Ripple
220			35×50	1.2	35×50	1.2
330	35×60	1.5	35×60	1.5	35×60	1.5
470	35×80	2.0	35×80	3.0	35×80	3.0
680	35×100	3.0	35×120	3.5	35×120	3.6
			51×80	3.7	51×80	3.8
1000	35×120	4.0	51×80	4.3	51×80	4.2
	51×80	4.2			51×105	4.7
1500	51×80	5.2	51×105	5.8	51×120	6.2
	51×100	6.2	51×120	6.3		
2200	51×105	7.0	51×130	8.3	63.5×100	7.3
	51×120	7.5	63.5×100	7.5	63.5×120	8.0
2700	63.5×80	7.9	63.5×105	9.0	63.5×130	9.8
3300	63.5×120	9.8	76.2×105	10.6	76.2×120	11.0
			76.2×120	11.0		
3900	63.5×120	10.0	76.2×120	12.0	76.2×145	13.0
4700	63.5×145	11.5	76.2×120	13.2	76.2×120	13.0
	76.2×105	11.5	76.2×130	13.7	76.2×160	14.7
5600	76.2×130	13.4	76.2×145	15.5	76.2×160	15.5
					89×145	17.3
6800	76.2×140	15.0	76.2×160	17.5	76.2×160	17.3
			89×145	18.3	76.2×220	19.7
8200	76.2×160	18.4	89×160	20.0	89×180	21.0
	89×145	19.5				
10000	76.2×160	19.5	89×160	22.0	89×200	24.0
	76.2×190	21.0				
12000	89×140	21.0	89×180	26.0		
	76.2×220	25.0				
15000	89×170	26.0	89×200	28.0		
	89×190	27.0				
18000	89×220	31.0				

Ripple Current(A,rms) at 105°C 120Hz

Useful life

depending on ambient temperature T_a versus under ripple current operating conditions

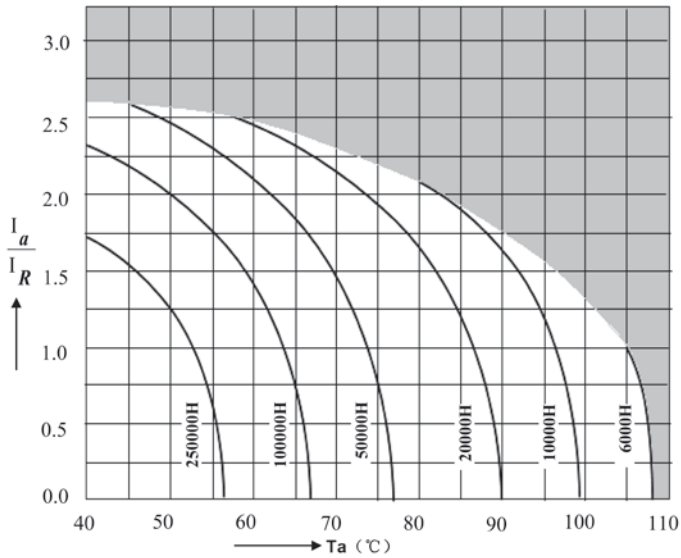

Frequency factor of permissible ripple current I_{RC} versus frequency f

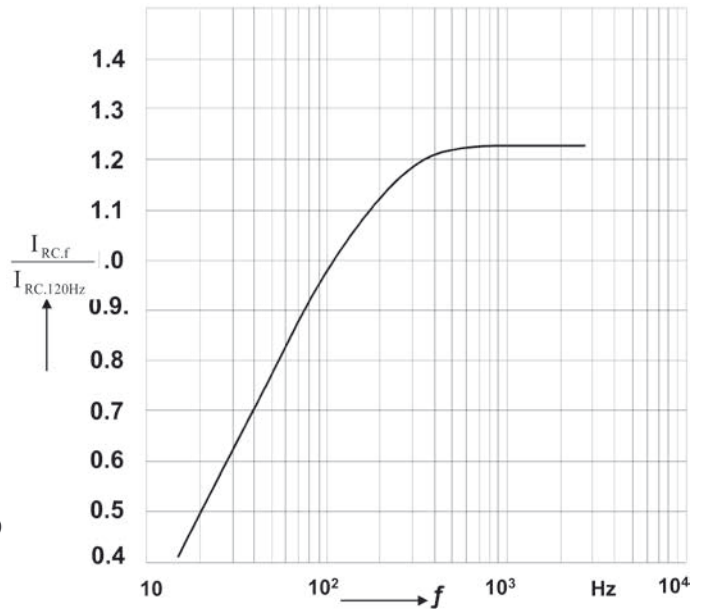

Frequency characteristics of ESR Typical behavior

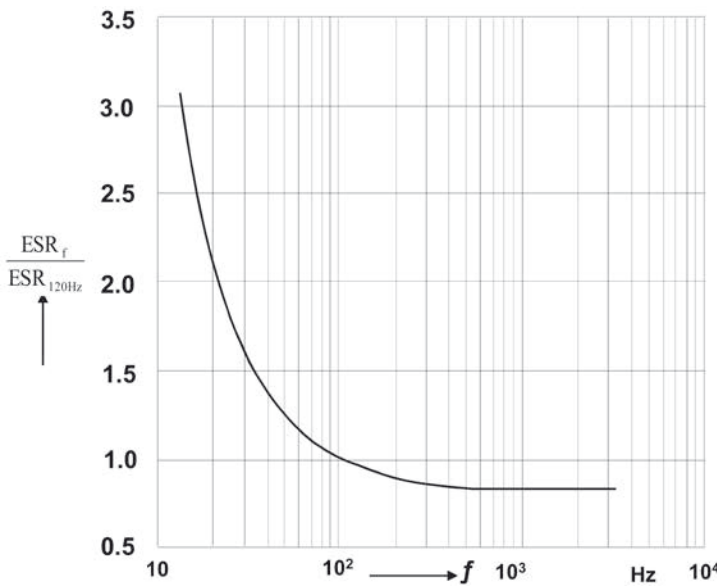

Impedance Z versus frequency f

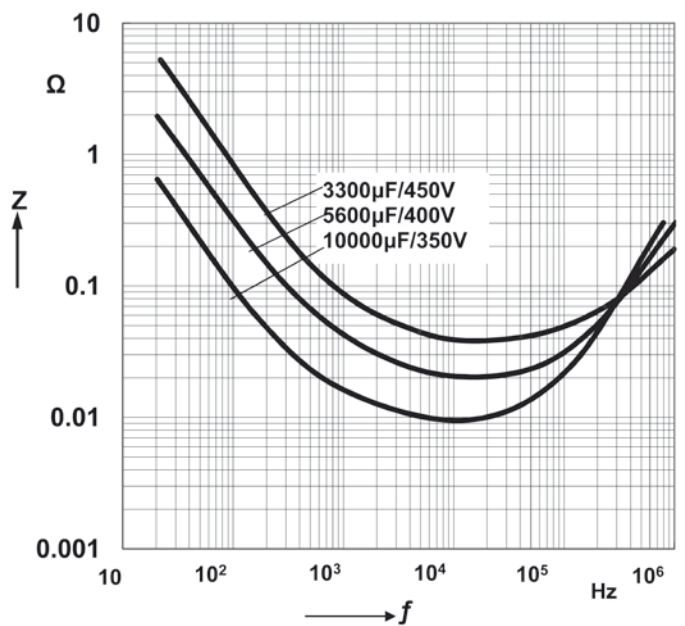

RH Series 105°C

Features

Extremely Long useful life

Applications

- ◆ Frequency converters
- ◆ Professional power supplies
- ◆ Traction

Features

- ◆ Outstanding reliability
- ◆ Wide temperature range
- ◆ Extra long useful life
- ◆ Version with low-inductance design available
- ◆ All-welded construction ensures reliable electrical contact
- ◆ Self-extinguishing electrolyte
- ◆ RoHS-compatible

Construction

- ◆ Charge-discharge proof, polar
- ◆ Aluminum case with insulating sleeve
- ◆ Poles with screw terminal connections
- ◆ Mounting with ring clips, clamps or threaded stud



Specifications

Item	Performance Characteristics					
Rated voltage V_R	160... 450 V DC					
Surge voltage V_S	1.15 V_R (for $V_R \leq 315$ V) or 1.10 V_R (for $V_R > 315$ V)					
Rated capacitance C_R	220 ... 47000 μ F					
Capacitance tolerance	$\pm 20\%$					
tan δ (at 20°C , 120Hz)	Less than the value under table(%)					
	ΦD	35	51	63.5	76.2	89
	WV	15	15	20	20	20
		20	20	25	25	25
Leakage Current I_{leak} (20 °C, 5 min)	$I_{leak} \leq 0.3\mu A * (C*V)^{0.7} + 4\mu A$					
Self-inductance ESL	d = 51 mm: approx. 17 nH					
	d \geq 63.5 mm: approx. 20 nH					
	Capacitors with low-inductance design:					
	d \geq 63.5 mm: approx. 15 nH					
Useful life 105 °C; V_R, I_{AC^*R}	> 8000 h	Requirements: $\Delta C/C \leq \pm 40\%$ of initial value ESR \leq 4 times initial specified limit $I_{leak} \leq$ initial specified limit				
Voltage Endurance test 105 °C; V_R	2000 h	Post test requirements: $\Delta C/C \leq \pm 20\%$ of initial value ESR \leq 2 times initial specified limit $I_{leak} \leq$ initial specified limit				
Vibration Resistance test	To IEC 60068-2-6, test Fc:					
	Displacement amplitude 0.75 mm, frequency range 10 ... 55 Hz, acceleration max. 10 g, duration 3X2 h. Capacitor mounted by its body which is rigidly clamped to the work surface.					
Low Temperature Characteristics	Max. impedance ratio at 120 Hz					
	V_R	≤ 400 V	≥ 450 V			
	$Z_{-25^\circ C} / Z_{20^\circ C}$	4	4			
	$Z_{-40^\circ C} / Z_{20^\circ C}$	10	10			
Sectional specification	IEC 60384-4 and JIS-C-5101					

Dimensional drawings

Ring clip/clamp mounting:

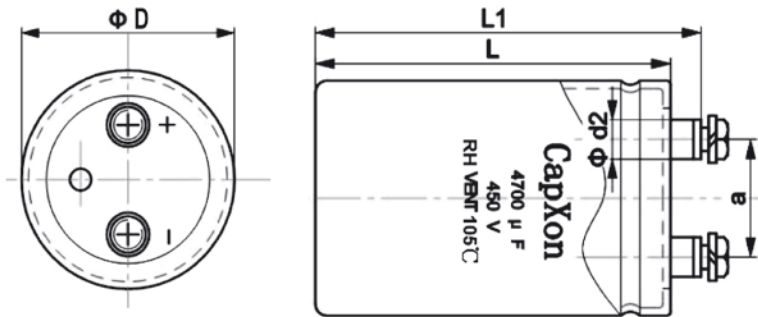

M5:Min.reach of screw = 8mm
M6:Min.reach of screw = 12mm

Dimensions

Terminal	Dimensions(mm) with insulating sleeve				
	$D \pm 2$	$L \pm 3$	$L_1 \pm 3$	$d_2 \text{max.}$	$a \pm 0.5$
M5	35	50~120	56.5~126.5	10.3	12.7
M5	51	80~140	86.5~146.5	10.3	22
M5	63.5	80~140	86.5~146.5	10.3	28.6
M5	76.2/89	100~240	106.4~246.5	10.3	31.8
M6	76.2/89	100~240	106.4~246.5	17.5	31.8

Packing

Diameter D(mm)	Length L(mm)	Packing (pcs.)
35	$\leq 70\text{mm}$	120
	$> 70\text{mm}$	60
42	$\leq 70\text{mm}$	120
	$> 70\text{mm}$	60
51	$\leq 70\text{mm}$	70
	$> 70\text{mm}$	35
63.5	all	24
76.2	all	15
89	all	12

Accessories

The following items are included in the delivery package, but are not fastened to the capacitors.

	Thread	Maximum torque
For terminal	M5	2 Nm
	M6	2.5 Nm

Case Size

φ DxL(mm)

WV(V) Cap(μF)	160		200		250	
	Size	Ripple	Size	Ripple	Size	Ripple
470					35×60	1.2
680			35×50	1.4	35×80	1.7
1000	35×60	1.9	35×60	2.0	35×100	2.5
1500	35×80	2.5	35×80	2.5	51×80	2.9
2200	35×100	3.3	35×120	3.6	51×100	4.0
			51×80	3.6		
3300	35×120	4.5	51×80	4.6	51×140	5.3
	51×80	4.5	51×100	4.8	63.5×100	5.0
4700	51×100	5.5	51×140	6.4	63.5×120	6.6
			63.5×100	6.2		
6800	51×140	7.8	63.5×120	7.7	76.2×120	8.3
	63.5×100	7.5				
10000	63.5×120	8.8	76.2×120	10.0	76.2×160	11.0
					89×140	11.5
15000	76.2×120	10.8	76.2×140	11.5	89×170	14.5
			76.2×160	12.2		
22000	76.2×140	13.8	76.2×160	15.5	89×220	17.0
	89×130	14.5	89×140	16.5		
33000	89×140	15.5				
47000	89×220	19.2				

Ripple Current(A,rms) at 105°C 120Hz

WV(V) Cap(μF)	350		400		450	
	Size	Ripple	Size	Ripple	Size	Ripple
220			35×50	1.4	35×50	1.4
330	35×60	1.6	35×60	1.7	35×60	1.7
470	35×80	2.3	35×80	3.3	35×80	3.5
680	35×100	3.3	35×120	3.9	35×120	4.2
			51×80	4.1	51×80	5.5
1000	35×120	4.4	51×80	4.7	51×80	4.8
	51×80	4.6			51×105	5.5
1500	51×80	5.7	51×105	6.4	51×120	7.1
	51×100	6.8	51×120	7.0		
2200	51×105	7.7	51×130	9.1	63.5×100	8.4
	51×120	8.3	63.5×100	8.3	63.5×120	9.2
	51×140	8.8				
2700	63.5×80	8.7	63.5×105	10.0	63.5×130	11.3
3300	63.5×100	10.0	63.5×130	11.5	63.5×145	13.2
	63.5×120	10.8	76.2×105	11.7	76.2×120	12.7
			76.2×120	12.2		
3900	63.5×120	11.5	76.2×120	13.0	76.2×145	15.0
4700	63.5×145	12.6	76.2×120	14.5	76.2×120	15.0
	76.2×105	12.6	76.2×130	15.0	76.2×160	17.0
	76.2×120	13.0				
5600	76.2×130	14.8	76.2×145	17.0	76.2×160	17.8
					89×145	20.0
6800	76.2×140	16.5	76.2×160	19.3	76.2×160	20.0
			89×145	20.0	76.2×220	22.0
					89×170	23.0
8200	76.2×160	20.0	89×160	22.0	89×180	24.0
	89×145	21.5				
10000	76.2×160	21.5	89×160	24.0	89×200	27.0
	76.2×190	23.0				
	89×140	23.0				
12000	76.2×220	27.5	89×180	28.0		
	89×170	28.5				
15000	89×190	30.0	89×200	31.0		
18000	89×220	34.0				

Ripple Current(A,rms) at 105°C 120Hz

Useful life

depending on ambient temperature T_a versus under ripple current operating conditions

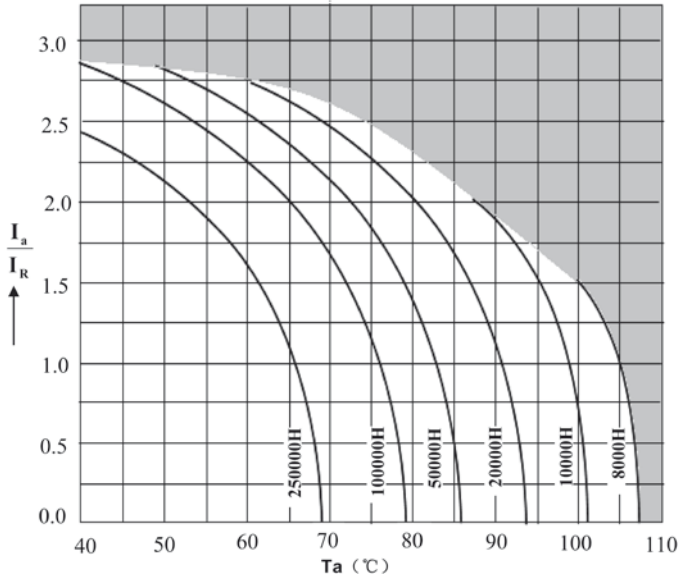

Frequency factor of permissible ripple current I_{RC} versus frequency f

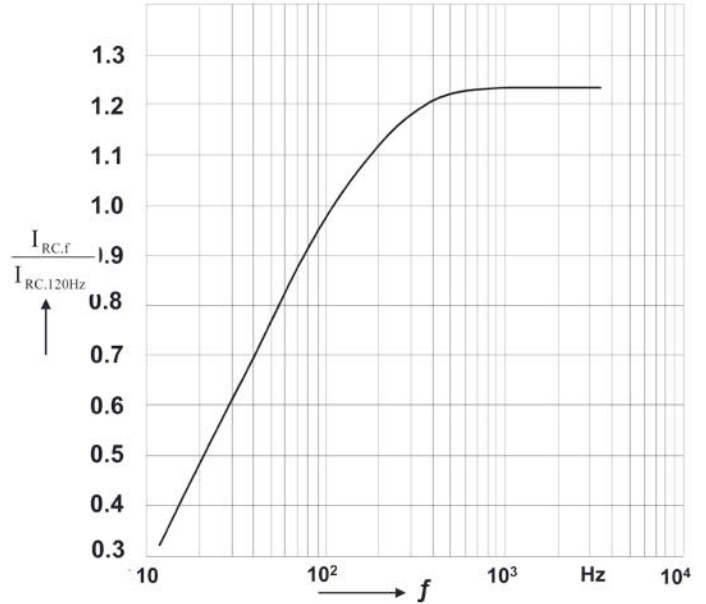

Frequency characteristics of ESR Typical behavior

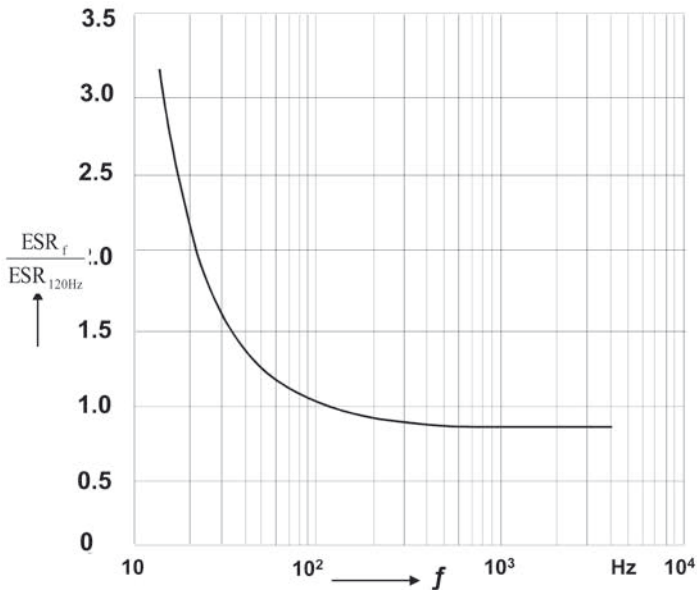

Impedance Z versus frequency f

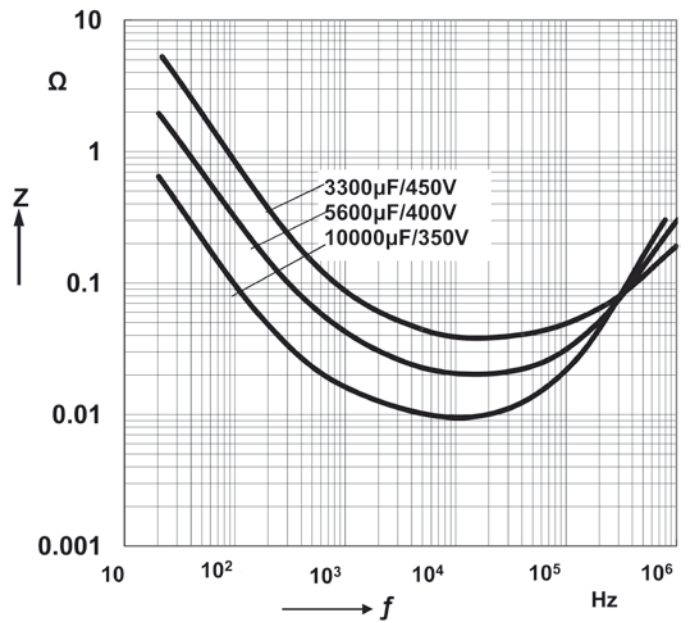

RQ Series 105°C

Features

Long useful life

Applications

- ◆ Frequency converters
- ◆ Professional power supplies
- ◆ Hybrid electric vehicles(HEV)
- ◆ Traction

Construction

- ◆ Charge-discharge proof, polar
- ◆ Aluminum case with insulating sleeve
- ◆ Poles with screw terminal connections
- ◆ Mounting with ring clips, clamps or threaded stud



Features

- ◆ High reliability ◆ Long useful life
- ◆ Extremely high ripple current capability
- ◆ Wide temperature range
- ◆ All-welded construction ensures reliable electrical contact
- ◆ Low-inductance design
- ◆ Self-extinguishing electrolyte
- ◆ RoHS-compatible

Specifications

Item	Performance Characteristics					
Rated voltage V_R	160... 450 V DC					
Surge voltage V_S	1.15 V_R (for $V_R \leq 315$ V) or 1.10 V_R (for $V_R > 315$ V)					
Rated capacitance C_R	2200 ... 47000 μ F					
Capacitance tolerance	$\pm 20\%$					
tan δ (at 20°C · 120Hz)	Less than the value under table(%)					
	ΦD	35	51	63.5	76.2	89
	WV	15	15	20	20	20
Leakage Current I_{leak} (20 °C, 5 min)	$I_{leak} \leq 0.3\mu A * (C*V)^{0.7} + 4\mu A$					
Self-inductance ESL	d = 51 mm: approx. 16 nH					
	d \geq 63.5 mm: approx. 18 nH					
	Capacitors with low-inductance design: d \geq 63.5 mm: approx. 14 nH					
Useful life 105 °C; V_R, I_{ACR}	> 6000 h	Requirements: $\Delta C/C \leq \pm 40\%$ of initial value ESR \leq 4 times initial specified limit $I_{leak} \leq$ initial specified limit				
Voltage Endurance test 105 °C; V_R	2000 h	Post test requirements: $\Delta C/C \leq \pm 20\%$ of initial value ESR \leq 2 times initial specified limit $I_{leak} \leq$ initial specified limit				
Vibration Resistance test	To IEC 60068-2-6, test Fc:					
	Displacement amplitude 0.75 mm, frequency range 10 ... 55 Hz, acceleration max. 10 g, duration 3X2 h. Capacitor mounted by its body which is rigidly clamped to the work surface.					
Low Temperature Characteristics	Max. impedance ratio at 120 Hz					
	V_R	≤ 400 V	≥ 450 V			
	$Z_{-25^\circ C} / Z_{20^\circ C}$	4	4			
	$Z_{-40^\circ C} / Z_{20^\circ C}$	10	10			
Sectional specification	IEC 60384-4 and JIS-C-5101					

Dimensional drawings

Ring clip/clamp mounting:

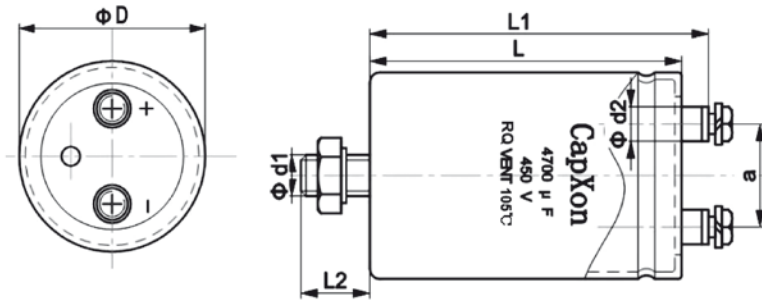

M5: Min. reach of screw = 8mm
M6: Min. reach of screw = 12mm

Dimensions

Terminal	Dimensions(mm) with insulating sleeve						
	$D \pm 2$	$L \pm 3$	$L_1 \pm 3$	$L_2 \pm 1$	d_1	$d_2 \text{ max.}$	$a \pm 0.5$
M5	63.5	80~140	86.5~146.5	16	M12	10.3	28.6
M5	76.2/89	100~240	106.4~246.5	16	M12	10.3	31.8
M6	76.2/89	100~240	106.4~246.5	16	M12	17.5	31.8

Packing

Diameter D(mm)	Length L(mm)	Packing (pcs.)
63.5	all	24
76.2	all	15
89	all	12

Accessories

The following items are included in the delivery package, but are not fastened to the capacitors.

	Thread	Maximum torque
For terminal	M5	2 Nm
	M6	2.5 Nm

Case Size

φ D×L(mm)

WV(V) Cap(μF)	160		200		250	
	Size	Ripple	Size	Ripple	Size	Ripple
3300					63.5×100	7.5
4700			63.5×100	8.8	63.5×120	9.5
6800	63.5×100	11.0	63.5×120	12.0	76.2×120	13.0
10000	63.5×120	12.5	76.2×120	13.5	76.2×160	15.0
					89×140	16.0
15000	76.2×120	15.5	76.2×140	16.0	89×170	20.0
			76.2×160	17.0		
22000	76.2×140	20.0	76.2×160	22.0	89×220	24.5
	89×130	21.0	89×140	24.0		
33000	89×140	22.0				
47000	89×220	28.0				

Ripple Current(A,rms) at 105°C 120Hz

WV(V) Cap(μF)	350		400		450	
	Size	Ripple	Size	Ripple	Size	Ripple
2200			63.5×100	13.5	63.5×100	13.0
					63.5×120	14.0
2700	63.5×80	16.0	63.5×105	16.5	63.5×130	16.0
3300	63.5×100	16.5	63.5×130	17.5	63.5×145	18.5
	63.5×120	17.5	76.2×105	20.2	76.2×120	19.0
3900			76.2×120	21.0		
	63.5×120	17.7	76.2×120	22.2	76.2×145	22.0
4700	63.5×145	18.6	76.2×120	23.5	76.2×120	21.0
	76.2×105	22.4	76.2×130	24.5	76.2×160	23.0
	76.2×120	23.0				
5600	76.2×130	24.0	76.2×145	27.0	76.2×160	23.5
					89×145	30.5
6800	76.2×140	26.0	76.2×160	28.6	76.2×160	26.5
			89×145	33.0	76.2×220	30.5
					89×170	39.0
8200	76.2×160	30.0	89×160	35.0	89×180	42.0
	89×145	34.5				
10000	76.2×160	30.5	89×160	39.0	89×200	45.0
	76.2×190	33.0				
	89×140	38.4				
12000	76.2×220	35.0	89×180	40.0		
	89×170	37.0				
15000	89×190	38.0	89×200	42.0		
18000	89×220	49.0				

Ripple Current(A,rms) at 105°C 120Hz

Useful life

depending on ambient temperature T_a versus under ripple current operating conditions

Frequency factor of permissible ripple current I_{RC} versus frequency f

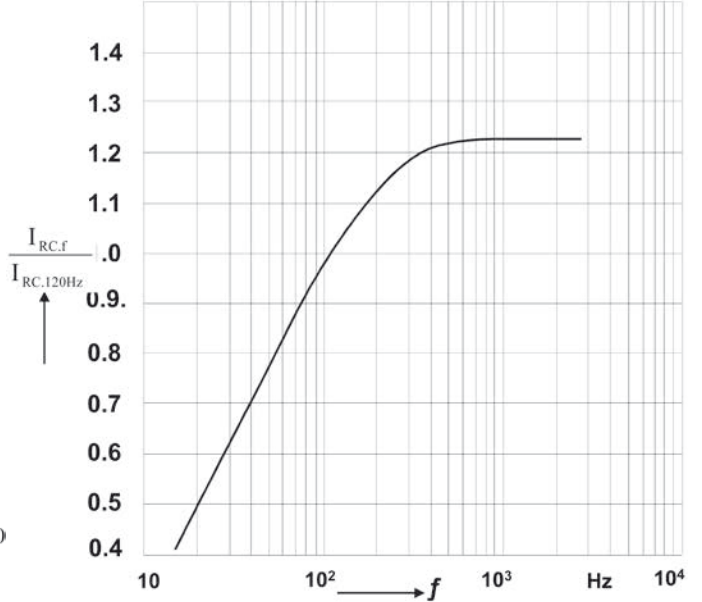
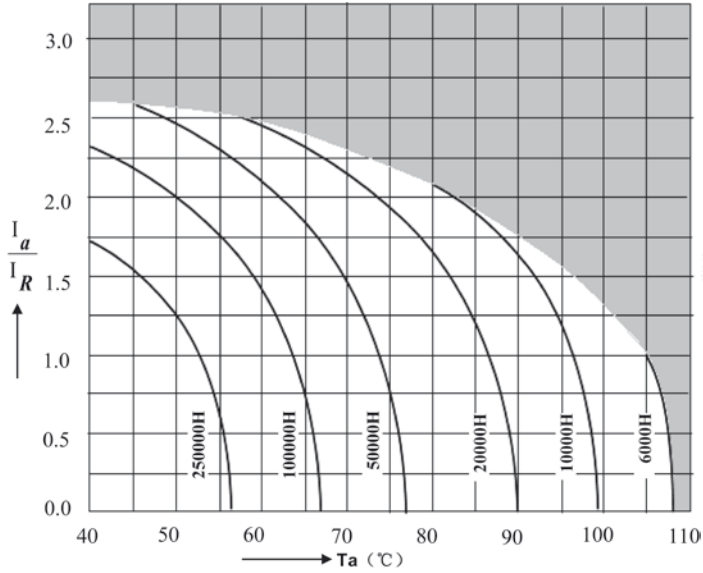

Frequency characteristics of ESR Typical behavior

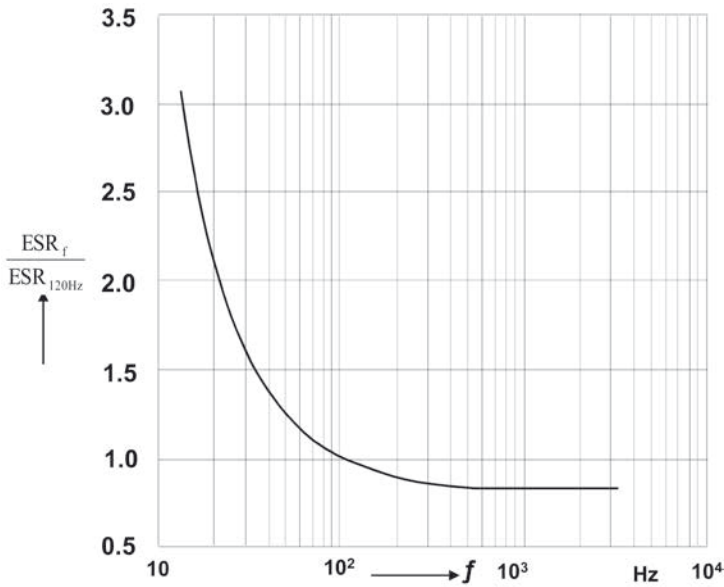

Impedance Z versus frequency f

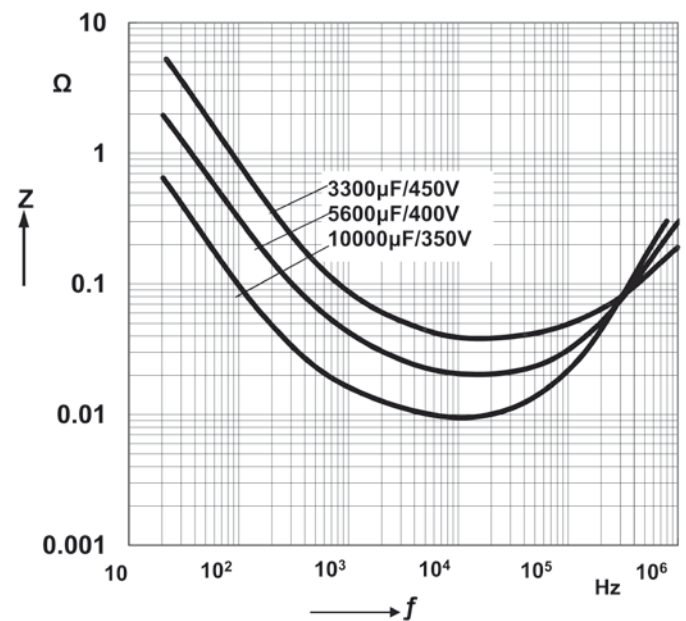

RT Series 105°C

Features

Extremely Long useful life

Applications

- ◆ Frequency converters
- ◆ Professional power supplies
- ◆ Traction

Features

- ◆ Outstanding reliability
- ◆ Wide temperature range
- ◆ Extra long useful life
- ◆ Version with low-inductance design available
- ◆ All-welded construction ensures reliable electrical contact
- ◆ Self-extinguishing electrolyte
- ◆ RoHS-compatible

Construction

- ◆ Charge-discharge proof, polar
- ◆ Aluminum case with insulating sleeve
- ◆ Poles with screw terminal connections
- ◆ Mounting with ring clips, clamps or threaded stud



Specifications

Item	Performance Characteristics					
Rated voltage V_R	160... 450 V DC					
Surge voltage V_S	1.15 V_R (for $V_R \leq 315$ V) or 1.10 V_R (for $V_R > 315$ V)					
Rated capacitance C_R	220 ... 47000 μ F					
Capacitance tolerance	$\pm 20\%$					
tan δ (at 20°C · 120Hz)	Less than the value under table(%)					
	ΦD	35	51	63.5	76.2	89
	WV	15	15	20	20	20
Leakage Current I_{leak} (20 °C, 5 min)	$I_{leak} \leq 0.3\mu A * (C*V)^{0.7} + 4\mu A$					
Self-inductance ESL	d = 51 mm: approx. 17 nH					
	d \geq 63.5 mm: approx. 20 nH					
	Capacitors with low-inductance design:					
	d \geq 63.5 mm: approx. 15 nH					
Useful life 105 °C; V_R, I_{ACR}	> 8000 h	Requirements: $\Delta C/C \leq \pm 40\%$ of initial value ESR \leq 4 times initial specified limit $I_{leak} \leq$ initial specified limit				
Voltage Endurance test 105 °C; V_R	2000 h	Post test requirements: $\Delta C/C \leq \pm 20\%$ of initial value ESR \leq 2 times initial specified limit $I_{leak} \leq$ initial specified limit				
Vibration Resistance test	To IEC 60068-2-6, test Fc:					
	Displacement amplitude 0.75 mm, frequency range 10 ... 55 Hz, acceleration max. 10 g, duration 3X2 h. Capacitor mounted by its body which is rigidly clamped to the work surface.					
Low Temperature Characteristics	Max. impedance ratio at 120 Hz					
	V_R	≤ 400 V	≥ 450 V			
	$Z_{-25^\circ C} / Z_{20^\circ C}$	4	4			
	$Z_{-40^\circ C} / Z_{20^\circ C}$	10	10			
Sectional specification	IEC 60384-4 and JIS-C-5101					

Dimensional drawings

Ring clip/clamp mounting:

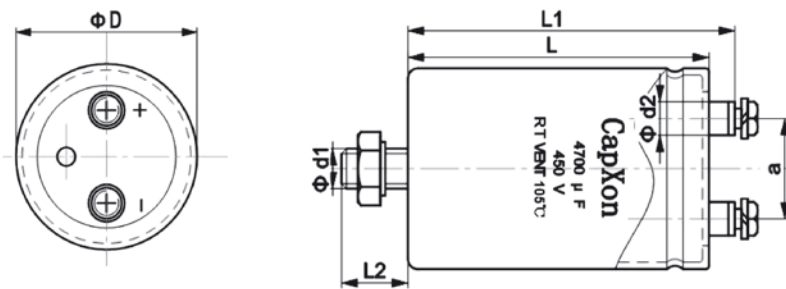

M5:Min.reach of screw = 8mm
M6:Min.reach of screw = 12mm

Dimensions

Terminal	Dimensions(mm) with insulating sleeve						
	$D \pm 2$	$L \pm 3$	$L_1 \pm 3$	$L_2 \pm 1$	d_1	$d_2 \text{ max.}$	$a \pm 0.5$
M5	63.5	80~140	86.5~146.5	16	M12	10.3	28.6
M5	76.2/89	100~240	106.4~246.5	16	M12	10.3	31.8
M6	76.2/89	100~240	106.4~246.5	16	M12	17.5	31.8

Packing

Diameter D(mm)	Length L(mm)	Packing (pcs.)
63.5	all	24
76.2	all	15
89	all	12

Accessories

The following items are included in the delivery package, but are not fastened to the capacitors.

	Thread	Maximum torque
For terminal	M5	2 Nm
	M6	2.5 Nm
For mounting	M12	10 Nm

Case Size

φ D×L(mm)

WV(V) Cap(μF)	160		200		250	
	Size	Ripple	Size	Ripple	Size	Ripple
3300					63.5×100	8.3
4700			63.5×100	9.7	63.5×120	10.5
6800	63.5×100	12.0	63.5×120	13.5	76.2×120	14.5
10000	63.5×120	13.8	76.2×120	15.0	76.2×160	16.5
					89×140	17.5
15000	76.2×120	17.0	76.2×140	17.5	89×170	22.0
			76.2×160	18.5		
22000	76.2×140	22.0	76.2×160	24.0	89×220	27.0
	89×130	23.0	89×140	26.0		
33000	89×140	24.0				
47000	89×220	31.0				

Ripple Current(A,rms) at 105°C 120Hz

WV(V) Cap(μF)	350		400		450	
	Size	Ripple	Size	Ripple	Size	Ripple
2200			63.5×100	14.8	63.5×100	15.0
					63.5×120	16.0
2700	63.5×80	17.5	63.5×105	18.2	63.5×130	18.5
3300	63.5×100	18.0	63.5×130	19.3	63.5×145	21.5
	63.5×120	19.0	76.2×105	22.0	76.2×120	22.0
3900			76.2×120	23.0		
	63.5×120	19.5	76.2×120	24.0	76.2×145	25.5
4700	63.5×145	20.5	76.2×120	25.8	76.2×120	24.3
	76.2×105	24.6	76.2×130	27.0	76.2×160	26.5
	76.2×120	25.5				
5600	76.2×130	26.5	76.2×145	30.0	76.2×160	27.3
					89×145	35.0
6800	76.2×140	28.5	76.2×160	31.5	76.2×160	30.7
			89×145	36.0	76.2×220	35.0
					89×170	45.0
8200	76.2×160	33.0	89×160	38.5	89×180	48.0
	89×145	39.0				
10000	76.2×160	33.5	89×160	43.0	89×200	50.0
	76.2×190	36.0				
	89×140	42.0				
12000	76.2×220	38.0	89×180	44.0		
	89×170	40.0				
15000	89×190	42.0	89×200	46.0		
18000	89×220	51.0				

Ripple Current(A,rms) at 105°C 120Hz

Useful life

depending on ambient temperature T_a versus under ripple current operating conditions

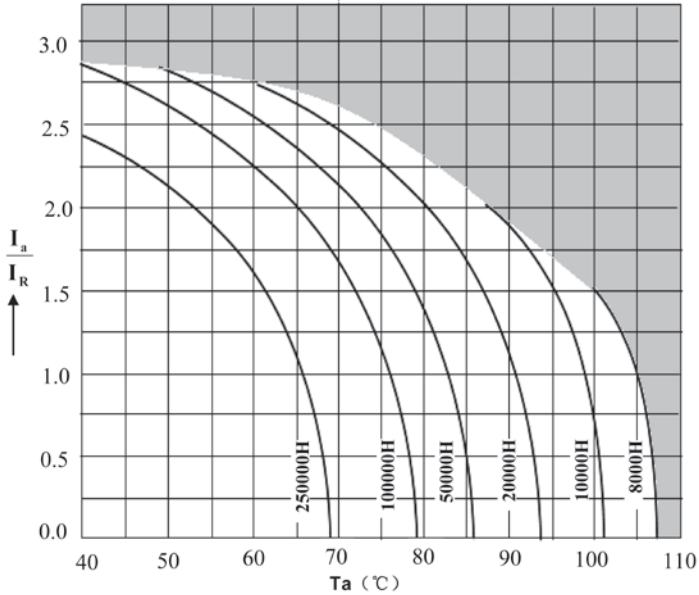

Frequency factor of permissible ripple current I_{RC} versus frequency f

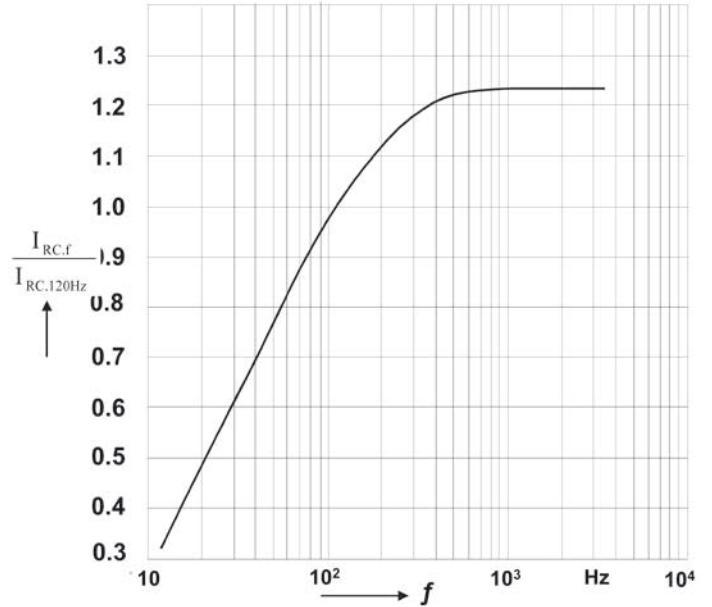

Frequency characteristics of ESR Typical behavior

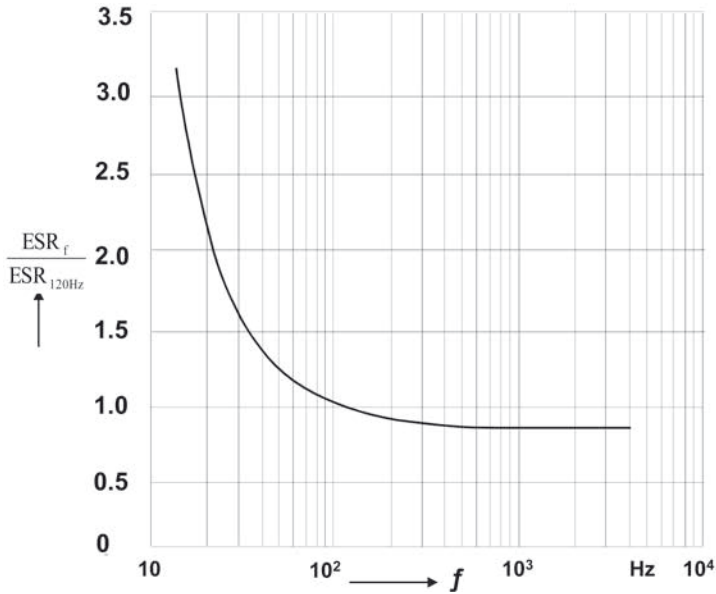

Impedance Z versus frequency f

